

Reference Specification

Leaded MLCC for Automotive with AEC-Q200
RCE Series

Product specifications in this catalog are as of Jun. 2022, and are subject to change or obsolescence without notice.
Please consult the approval sheet before ordering. Please read rating and Cautions first.

⚠ CAUTION**1. OPERATING VOLTAGE**

When DC-rated capacitors are to be used in AC or ripple current circuits, be sure to maintain the V_{p-p} value of the applied voltage or the V_{o-p} which contains DC bias within the rated voltage range. When the voltage is started to apply to the circuit or it is stopped applying, the irregular voltage may be generated for a transit period because of resonance or switching. Be sure to use a capacitor within rated voltage containing these irregular voltage.

When DC-rated capacitors are to be used in input circuits from commercial power source (AC filter), be sure to use Safety Recognized Capacitors because various regulations on withstand voltage or impulse withstand established for each equipment should be taken into considerations.

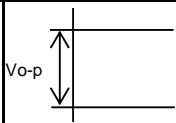
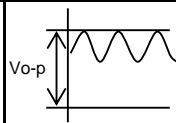
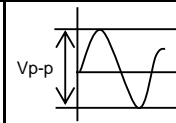
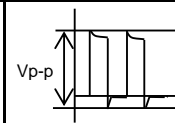
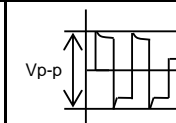
Voltage	DC Voltage	DC+AC Voltage	AC Voltage	Pulse Voltage(1)	Pulse Voltage(2)
Positional Measurement					

2. OPERATING TEMPERATURE AND SELF-GENERATED HEAT

Keep the surface temperature of a capacitor below the upper limit of its rated operating temperature range. Be sure to take into account the heat generated by the capacitor itself.

When the capacitor is used in a high-frequency current, pulse current or the like, it may have the self-generated heat due to dielectric-loss. In case of Class 2 capacitors (Temp.Char. : X7R, X7S, X8L, etc.), applied voltage should be the load such as self-generated heat is within 20 °C on the condition of atmosphere temperature 25 °C. Please contact us if self-generated heat is occurred with Class 1 capacitors (Temp.Char. : C0G, U2J, X8G, etc.). When measuring, use a thermocouple of small thermal capacity-K of $\Phi 0.1\text{mm}$ and be in the condition where capacitor is not affected by radiant heat of other components and wind of surroundings. Excessive heat may lead to deterioration of the capacitor's characteristics and reliability.

3. FAIL-SAFE

Be sure to provide an appropriate fail-safe function on your product to prevent a second damage that may be caused by the abnormal function or the failure of our product.

4. OPERATING AND STORAGE ENVIRONMENT

The insulating coating of capacitors does not form a perfect seal; therefore, do not use or store capacitors in a corrosive atmosphere, especially where chloride gas, sulfide gas, acid, alkali, salt or the like are present. And avoid exposure to moisture. Before cleaning, bonding, or molding this product, verify that these processes do not affect product quality by testing the performance of a cleaned, bonded or molded product in the intended equipment. Store the capacitors where the temperature and relative humidity do not exceed 5 to 40 °C and 20 to 70%. Use capacitors within 6 months.

5. VIBRATION AND IMPACT

Do not expose a capacitor or its leads to excessive shock or vibration during use.

6. SOLDERING

When soldering this product to a PCB/PWB, do not exceed the solder heat resistance specification of the capacitor. Subjecting this product to excessive heating could melt the internal junction solder and may result in thermal shocks that can crack the ceramic element.

7. BONDING AND RESIN MOLDING, RESIN COAT

In case of bonding, molding or coating this product, verify that these processes do not affect the quality of capacitor by testing the performance of a bonded or molded product in the intended equipment.

In case of the amount of applications, dryness / hardening conditions of adhesives and molding resins containing organic solvents (ethyl acetate, methyl ethyl ketone, toluene, etc.) are unsuitable, the outer coating resin of a capacitor is damaged by the organic solvents and it may result, worst case, in a short circuit.

The variation in thickness of adhesive or molding resin may cause a outer coating resin cracking and/or ceramic element cracking of a capacitor in a temperature cycling.

8. TREATMENT AFTER BONDING AND RESIN MOLDING, RESIN COAT

When the outer coating is hot (over 100 °C) after soldering, it becomes soft and fragile.

So please be careful not to give it mechanical stress.

Failure to follow the above cautions may result, worst case, in a short circuit and cause fuming or partial dispersion when the product is used.

9. LIMITATION OF APPLICATIONS

Please contact us before using our products for the applications listed below which require especially high reliability for the prevention of defects which might directly cause damage to the third party's life, body or property.

1. Aircraft equipment
2. Aerospace equipment
3. Undersea equipment
4. Power plant control equipment
5. Medical equipment
6. Transportation equipment (vehicles, trains, ships, etc.)
7. Traffic signal equipment
8. Disaster prevention / crime prevention equipment
9. Data-processing equipment exerting influence on public
10. Application of similar complexity and/or reliability requirements to the applications listed in the above.

NOTICE

1. CLEANING (ULTRASONIC CLEANING)

To perform ultrasonic cleaning, observe the following conditions.

Rinse bath capacity : Output of 20 watts per liter or less.

Rinsing time : 5 min maximum.

Do not vibrate the PCB/PWB directly.

Excessive ultrasonic cleaning may lead to fatigue destruction of the lead wires.

2. SOLDERING AND MOUNTING

Insertion of the Lead Wire

- When soldering, insert the lead wire into the PCB without mechanically stressing the lead wire.
- Insert the lead wire into the PCB with a distance appropriate to the lead space.

3. CAPACITANCE CHANGE OF CAPACITORS

- Class 2 capacitors (Temp.Char. : X7R,X7S,X8L etc.)

Class 2 capacitors an aging characteristic, whereby the capacitor continually decreases its capacitance slightly if the capacitor leaves for a long time. Moreover, capacitance might change greatly depending on a surrounding temperature or an applied voltage. So, it is not likely to be able to use for the time constant circuit.

Please contact us if you need a detail information.

NOTE

1. Please make sure that your product has been evaluated in view of your specifications with our product being mounted to your product.
2. You are requested not to use our product deviating from this specification.

Reference only

1. Application

This specification is applied to Leaded MLCC RCE series in accordance with AEC-Q200 requirements used for Automotive Electronic equipment.

2. Rating

• Part Number Configuration

ex.)

RCE	R7	1E	104	K	0	A2	H03	B
Series	Temperature Characteristics	Rated Voltage	Capacitance	Capacitance Tolerance	Dimension (LxW)	Lead Style	Individual Specification	Package

• Temperature Characteristics

Code	Temp. Char.	Temp. Range	Cap. Change	Standard Temp.	Operating Temp. Range
R7	X7R (EIA code)	-55~125°C	+/-15%	25°C	-55~125°C
C7	X7S (EIA code)	-55~125°C	+/-22%	25°C	-55~125°C

• Rated Voltage

Code	Rated voltage
1E	DC25V
1H	DC50V
2A	DC100V

• Capacitance

The first two digits denote significant figures ; the last digit denotes the multiplier of 10 in pF.

ex.) In case of 104

$$10 \times 10^4 = 100000 \text{pF}$$

• Capacitance Tolerance

Code	Capacitance Tolerance
K	+/-10%
M	+/-20%

• Dimension (LxW)

Please refer to [Part number list].

• Lead Style

*Lead wire is "solder coated CP wire".

Code	Lead Style	Lead spacing (mm)
A2	Straight type	2.5+/-0.8
DB	Straight taping type	2.5+0.4/-0.2
K1	Inside crimp type	5.0+/-0.8
M1	Inside crimp taping type	5.0+0.6/-0.2

• Individual Specification

Murata's control code.

Please refer to [Part number list].

4. Part number list

- Straight Long
(Lead Style:A2)

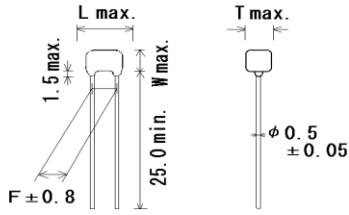

Unit : mm

Customer Part Number	Murata Part Number	T.C.	DC Rated Volt. (V)	Cap.	Cap. Tol.	Dimension (mm)					Dimension (LxW) Lead Style	Pack qty. (pcs)
						L	W	W1	F	T		
	RCER71E104K0A2H03B	X7R	25	0.1μF	±10%	3.6	3.5	-	2.5	2.5	0A2	500
	RCER71E154K0A2H03B	X7R	25	0.15μF	±10%	3.6	3.5	-	2.5	2.5	0A2	500
	RCER71E224K0A2H03B	X7R	25	0.22μF	±10%	3.6	3.5	-	2.5	2.5	0A2	500
	RCER71E334K1A2H03B	X7R	25	0.33μF	±10%	4.0	3.5	-	2.5	2.5	1A2	500
	RCER71E474K1A2H03B	X7R	25	0.47μF	±10%	4.0	3.5	-	2.5	2.5	1A2	500
	RCER71E684K1A2H03B	X7R	25	0.68μF	±10%	4.0	3.5	-	2.5	2.5	1A2	500
	RCER71E105K1A2H03B	X7R	25	1.0μF	±10%	4.0	3.5	-	2.5	2.5	1A2	500
	RCER71E155K2A2H03B	X7R	25	1.5μF	±10%	5.5	4.0	-	2.5	3.15	2A2	500
	RCER71E225K2A2H03B	X7R	25	2.2μF	±10%	5.5	4.0	-	2.5	3.15	2A2	500
	RCER71E335K2A2H03B	X7R	25	3.3μF	±10%	5.5	4.0	-	2.5	3.15	2A2	500
	RCER71E475K2A2H03B	X7R	25	4.7μF	±10%	5.5	4.0	-	2.5	3.15	2A2	500
	RCER71E106K3A2H03B	X7R	25	10μF	±10%	5.5	5.0	-	2.5	4.0	3A2	500
	RCER71H221K0A2H03B	X7R	50	220pF	±10%	3.6	3.5	-	2.5	2.5	0A2	500
	RCER71H331K0A2H03B	X7R	50	330pF	±10%	3.6	3.5	-	2.5	2.5	0A2	500
	RCER71H471K0A2H03B	X7R	50	470pF	±10%	3.6	3.5	-	2.5	2.5	0A2	500
	RCER71H681K0A2H03B	X7R	50	680pF	±10%	3.6	3.5	-	2.5	2.5	0A2	500
	RCER71H102K0A2H03B	X7R	50	1000pF	±10%	3.6	3.5	-	2.5	2.5	0A2	500
	RCER71H152K0A2H03B	X7R	50	1500pF	±10%	3.6	3.5	-	2.5	2.5	0A2	500
	RCER71H222K0A2H03B	X7R	50	2200pF	±10%	3.6	3.5	-	2.5	2.5	0A2	500
	RCER71H332K0A2H03B	X7R	50	3300pF	±10%	3.6	3.5	-	2.5	2.5	0A2	500
	RCER71H472K0A2H03B	X7R	50	4700pF	±10%	3.6	3.5	-	2.5	2.5	0A2	500
	RCER71H682K0A2H03B	X7R	50	6800pF	±10%	3.6	3.5	-	2.5	2.5	0A2	500
	RCER71H103K0A2H03B	X7R	50	10000pF	±10%	3.6	3.5	-	2.5	2.5	0A2	500
	RCER71H153K0A2H03B	X7R	50	15000pF	±10%	3.6	3.5	-	2.5	2.5	0A2	500
	RCER71H223K0A2H03B	X7R	50	22000pF	±10%	3.6	3.5	-	2.5	2.5	0A2	500
	RCER71H333K0A2H03B	X7R	50	33000pF	±10%	3.6	3.5	-	2.5	2.5	0A2	500
	RCER71H473K0A2H03B	X7R	50	47000pF	±10%	3.6	3.5	-	2.5	2.5	0A2	500
	RCER71H683K0A2H03B	X7R	50	68000pF	±10%	3.6	3.5	-	2.5	2.5	0A2	500
	RCER71H104K0A2H03B	X7R	50	0.1μF	±10%	3.6	3.5	-	2.5	2.5	0A2	500
	RCER71H154K1A2H03B	X7R	50	0.15μF	±10%	4.0	3.5	-	2.5	2.5	1A2	500
	RCER71H224K1A2H03B	X7R	50	0.22μF	±10%	4.0	3.5	-	2.5	2.5	1A2	500
	RCER71H334K1A2H03B	X7R	50	0.33μF	±10%	4.0	3.5	-	2.5	2.5	1A2	500
	RCER71H474K1A2H03B	X7R	50	0.47μF	±10%	4.0	3.5	-	2.5	2.5	1A2	500
	RCER71H684K2A2H03B	X7R	50	0.68μF	±10%	5.5	4.0	-	2.5	3.15	2A2	500
	RCEC71H105K1A2H03B	X7S	50	1.0μF	±10%	4.0	3.5	-	2.5	2.5	1A2	500
	RCER71H105K2A2H03B	X7R	50	1.0μF	±10%	5.5	4.0	-	2.5	3.15	2A2	500
	RCER71H155K2A2H03B	X7R	50	1.5μF	±10%	5.5	4.0	-	2.5	3.15	2A2	500
	RCER71H225K2A2H03B	X7R	50	2.2μF	±10%	5.5	4.0	-	2.5	3.15	2A2	500
	RCER71H335K3A2H03B	X7R	50	3.3μF	±10%	5.5	5.0	-	2.5	4.0	3A2	500
	RCEC71H475K2A2H03B	X7S	50	4.7μF	±10%	5.5	4.0	-	2.5	3.15	2A2	500

Reference only

- Straight Long
(Lead Style:A2)

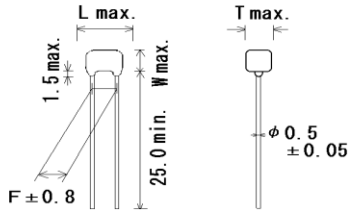

- Inside Crimp
(Lead Style:K*)

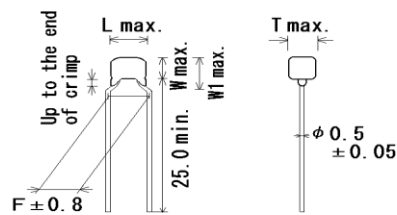

Unit : mm

Customer Part Number	Murata Part Number	T.C.	DC Rated Volt. (V)	Cap.	Cap. Tol.	Dimension (mm)					Dimension (LxW) Lead Style	Pack qty. (pcs)
						L	W	W1	F	T		
	RCER71H475K3A2H03B	X7R	50	4.7μF	±10%	5.5	5.0	-	2.5	4.0	3A2	500
	RCEC71H106K3A2H03B	X7S	50	10μF	±10%	5.5	5.0	-	2.5	4.0	3A2	500
	RCER72A221K0A2H03B	X7R	100	220pF	±10%	3.6	3.5	-	2.5	2.5	0A2	500
	RCER72A331K0A2H03B	X7R	100	330pF	±10%	3.6	3.5	-	2.5	2.5	0A2	500
	RCER72A471K0A2H03B	X7R	100	470pF	±10%	3.6	3.5	-	2.5	2.5	0A2	500
	RCER72A681K0A2H03B	X7R	100	680pF	±10%	3.6	3.5	-	2.5	2.5	0A2	500
	RCER72A102K0A2H03B	X7R	100	1000pF	±10%	3.6	3.5	-	2.5	2.5	0A2	500
	RCER72A152K0A2H03B	X7R	100	1500pF	±10%	3.6	3.5	-	2.5	2.5	0A2	500
	RCER72A222K0A2H03B	X7R	100	2200pF	±10%	3.6	3.5	-	2.5	2.5	0A2	500
	RCER72A332K0A2H03B	X7R	100	3300pF	±10%	3.6	3.5	-	2.5	2.5	0A2	500
	RCER72A472K0A2H03B	X7R	100	4700pF	±10%	3.6	3.5	-	2.5	2.5	0A2	500
	RCER72A682K0A2H03B	X7R	100	6800pF	±10%	3.6	3.5	-	2.5	2.5	0A2	500
	RCER72A103K0A2H03B	X7R	100	10000pF	±10%	3.6	3.5	-	2.5	2.5	0A2	500
	RCER72A153K0A2H03B	X7R	100	15000pF	±10%	3.6	3.5	-	2.5	2.5	0A2	500
	RCER72A223K0A2H03B	X7R	100	22000pF	±10%	3.6	3.5	-	2.5	2.5	0A2	500
	RCER72A333K1A2H03B	X7R	100	33000pF	±10%	4.0	3.5	-	2.5	2.5	1A2	500
	RCER72A473K1A2H03B	X7R	100	47000pF	±10%	4.0	3.5	-	2.5	2.5	1A2	500
	RCER72A683K1A2H03B	X7R	100	68000pF	±10%	4.0	3.5	-	2.5	2.5	1A2	500
	RCER72A104K1A2H03B	X7R	100	0.1μF	±10%	4.0	3.5	-	2.5	2.5	1A2	500
	RCER72A154K2A2H03B	X7R	100	0.15μF	±10%	5.5	4.0	-	2.5	3.15	2A2	500
	RCER72A224K2A2H03B	X7R	100	0.22μF	±10%	5.5	4.0	-	2.5	3.15	2A2	500
	RCER72A334K1A2H03B	X7R	100	0.33μF	±10%	4.0	3.5	-	2.5	2.5	1A2	500
	RCER72A474K2A2H03B	X7R	100	0.47μF	±10%	5.5	4.0	-	2.5	3.15	2A2	500
	RCER72A684K2A2H03B	X7R	100	0.68μF	±10%	5.5	4.0	-	2.5	3.15	2A2	500
	RCER72A105K2A2H03B	X7R	100	1.0μF	±10%	5.5	4.0	-	2.5	3.15	2A2	500
	RCEC72A155K3A2H03B	X7S	100	1.5μF	±10%	5.5	5.0	-	2.5	4.0	3A2	500
	RCEC72A225K3A2H03B	X7S	100	2.2μF	±10%	5.5	5.0	-	2.5	4.0	3A2	500
	RCER71E104K0K1H03B	X7R	25	0.1μF	±10%	3.6	3.5	6.0	5.0	2.5	0K1	500
	RCER71E154K0K1H03B	X7R	25	0.15μF	±10%	3.6	3.5	6.0	5.0	2.5	0K1	500
	RCER71E224K0K1H03B	X7R	25	0.22μF	±10%	3.6	3.5	6.0	5.0	2.5	0K1	500
	RCER71E334K1K1H03B	X7R	25	0.33μF	±10%	4.0	3.5	5.0	5.0	2.5	1K1	500
	RCER71E474K1K1H03B	X7R	25	0.47μF	±10%	4.0	3.5	5.0	5.0	2.5	1K1	500
	RCER71E684K1K1H03B	X7R	25	0.68μF	±10%	4.0	3.5	5.0	5.0	2.5	1K1	500
	RCER71E105K1K1H03B	X7R	25	1.0μF	±10%	4.0	3.5	5.0	5.0	2.5	1K1	500
	RCER71E155K2K1H03B	X7R	25	1.5μF	±10%	5.5	4.0	6.0	5.0	3.15	2K1	500
	RCER71E225K2K1H03B	X7R	25	2.2μF	±10%	5.5	4.0	6.0	5.0	3.15	2K1	500
	RCER71E335K2K1H03B	X7R	25	3.3μF	±10%	5.5	4.0	6.0	5.0	3.15	2K1	500
	RCER71E475K2K1H03B	X7R	25	4.7μF	±10%	5.5	4.0	6.0	5.0	3.15	2K1	500
	RCER71E106K3K1H03B	X7R	25	10μF	±10%	5.5	5.0	7.5	5.0	4.0	3K1	500
	RCER71E226MWK1H03B	X7R	25	22μF	±20%	5.5	7.5	10.0	5.0	4.0	WK1	500

• Inside Crimp
(Lead Style : K*)

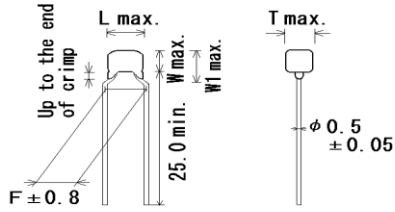

Unit : mm

Customer Part Number	Murata Part Number	T.C.	DC Rated Volt. (V)	Cap.	Cap. Tol.	Dimension (mm)					Dimension (LxW) Lead Style	Pack qty. (pcs)
						L	W	W1	F	T		
	RCER71H221K0K1H03B	X7R	50	220pF	±10%	3.6	3.5	6.0	5.0	2.5	0K1	500
	RCER71H331K0K1H03B	X7R	50	330pF	±10%	3.6	3.5	6.0	5.0	2.5	0K1	500
	RCER71H471K0K1H03B	X7R	50	470pF	±10%	3.6	3.5	6.0	5.0	2.5	0K1	500
	RCER71H681K0K1H03B	X7R	50	680pF	±10%	3.6	3.5	6.0	5.0	2.5	0K1	500
	RCER71H102K0K1H03B	X7R	50	1000pF	±10%	3.6	3.5	6.0	5.0	2.5	0K1	500
	RCER71H152K0K1H03B	X7R	50	1500pF	±10%	3.6	3.5	6.0	5.0	2.5	0K1	500
	RCER71H222K0K1H03B	X7R	50	2200pF	±10%	3.6	3.5	6.0	5.0	2.5	0K1	500
	RCER71H332K0K1H03B	X7R	50	3300pF	±10%	3.6	3.5	6.0	5.0	2.5	0K1	500
	RCER71H472K0K1H03B	X7R	50	4700pF	±10%	3.6	3.5	6.0	5.0	2.5	0K1	500
	RCER71H682K0K1H03B	X7R	50	6800pF	±10%	3.6	3.5	6.0	5.0	2.5	0K1	500
	RCER71H103K0K1H03B	X7R	50	10000pF	±10%	3.6	3.5	6.0	5.0	2.5	0K1	500
	RCER71H153K0K1H03B	X7R	50	15000pF	±10%	3.6	3.5	6.0	5.0	2.5	0K1	500
	RCER71H223K0K1H03B	X7R	50	22000pF	±10%	3.6	3.5	6.0	5.0	2.5	0K1	500
	RCER71H333K0K1H03B	X7R	50	33000pF	±10%	3.6	3.5	6.0	5.0	2.5	0K1	500
	RCER71H473K0K1H03B	X7R	50	47000pF	±10%	3.6	3.5	6.0	5.0	2.5	0K1	500
	RCER71H683K0K1H03B	X7R	50	68000pF	±10%	3.6	3.5	6.0	5.0	2.5	0K1	500
	RCER71H104K0K1H03B	X7R	50	0.1μF	±10%	3.6	3.5	6.0	5.0	2.5	0K1	500
	RCER71H154K1K1H03B	X7R	50	0.15μF	±10%	4.0	3.5	5.0	5.0	2.5	1K1	500
	RCER71H224K1K1H03B	X7R	50	0.22μF	±10%	4.0	3.5	5.0	5.0	2.5	1K1	500
	RCER71H334K1K1H03B	X7R	50	0.33μF	±10%	4.0	3.5	5.0	5.0	2.5	1K1	500
	RCER71H474K1K1H03B	X7R	50	0.47μF	±10%	4.0	3.5	5.0	5.0	2.5	1K1	500
	RCER71H684K2K1H03B	X7R	50	0.68μF	±10%	5.5	4.0	6.0	5.0	3.15	2K1	500
	RCEC71H105K1K1H03B	X7S	50	1.0μF	±10%	4.0	3.5	5.0	5.0	2.5	1K1	500
	RCER71H105K2K1H03B	X7R	50	1.0μF	±10%	5.5	4.0	6.0	5.0	3.15	2K1	500
	RCER71H155K2K1H03B	X7R	50	1.5μF	±10%	5.5	4.0	6.0	5.0	3.15	2K1	500
	RCER71H225K2K1H03B	X7R	50	2.2μF	±10%	5.5	4.0	6.0	5.0	3.15	2K1	500
	RCER71H335K3K1H03B	X7R	50	3.3μF	±10%	5.5	5.0	7.5	5.0	4.0	3K1	500
	RCEC71H475K2K1H03B	X7S	50	4.7μF	±10%	5.5	4.0	6.0	5.0	3.15	2K1	500
	RCER71H475K3K1H03B	X7R	50	4.7μF	±10%	5.5	5.0	7.5	5.0	4.0	3K1	500
	RCEC71H106K3K1H03B	X7S	50	10μF	±10%	5.5	5.0	7.5	5.0	4.0	3K1	500
	RCER71H106MWWK1H03B	X7R	50	10μF	±20%	5.5	7.5	10.0	5.0	4.0	WK1	500
	RCEC71H226MWWK1H03B	X7S	50	22μF	±20%	5.5	7.5	10.0	5.0	4.0	WK1	500
	RCER72A221K0K1H03B	X7R	100	220pF	±10%	3.6	3.5	6.0	5.0	2.5	0K1	500
	RCER72A331K0K1H03B	X7R	100	330pF	±10%	3.6	3.5	6.0	5.0	2.5	0K1	500
	RCER72A471K0K1H03B	X7R	100	470pF	±10%	3.6	3.5	6.0	5.0	2.5	0K1	500
	RCER72A681K0K1H03B	X7R	100	680pF	±10%	3.6	3.5	6.0	5.0	2.5	0K1	500
	RCER72A102K0K1H03B	X7R	100	1000pF	±10%	3.6	3.5	6.0	5.0	2.5	0K1	500
	RCER72A152K0K1H03B	X7R	100	1500pF	±10%	3.6	3.5	6.0	5.0	2.5	0K1	500
	RCER72A222K0K1H03B	X7R	100	2200pF	±10%	3.6	3.5	6.0	5.0	2.5	0K1	500
	RCER72A332K0K1H03B	X7R	100	3300pF	±10%	3.6	3.5	6.0	5.0	2.5	0K1	500

- Inside Crimp
(Lead Style : K*)

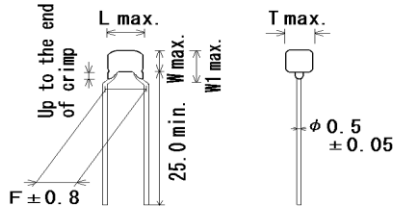

Unit : mm

Customer Part Number	Murata Part Number	T.C.	DC Rated Volt. (V)	Cap.	Cap. Tol.	Dimension (mm)					Dimension (LxW) Lead Style	Pack qty. (pcs)
						L	W	W1	F	T		
	RCER72A472K0K1H03B	X7R	100	4700pF	±10%	3.6	3.5	6.0	5.0	2.5	0K1	500
	RCER72A682K0K1H03B	X7R	100	6800pF	±10%	3.6	3.5	6.0	5.0	2.5	0K1	500
	RCER72A103K0K1H03B	X7R	100	10000pF	±10%	3.6	3.5	6.0	5.0	2.5	0K1	500
	RCER72A153K0K1H03B	X7R	100	15000pF	±10%	3.6	3.5	6.0	5.0	2.5	0K1	500
	RCER72A223K0K1H03B	X7R	100	22000pF	±10%	3.6	3.5	6.0	5.0	2.5	0K1	500
	RCER72A333K1K1H03B	X7R	100	33000pF	±10%	4.0	3.5	5.0	5.0	2.5	1K1	500
	RCER72A473K1K1H03B	X7R	100	47000pF	±10%	4.0	3.5	5.0	5.0	2.5	1K1	500
	RCER72A683K1K1H03B	X7R	100	68000pF	±10%	4.0	3.5	5.0	5.0	2.5	1K1	500
	RCER72A104K1K1H03B	X7R	100	0.1μF	±10%	4.0	3.5	5.0	5.0	2.5	1K1	500
	RCER72A154K2K1H03B	X7R	100	0.15μF	±10%	5.5	4.0	6.0	5.0	3.15	2K1	500
	RCER72A224K2K1H03B	X7R	100	0.22μF	±10%	5.5	4.0	6.0	5.0	3.15	2K1	500
	RCER72A334K1K1H03B	X7R	100	0.33μF	±10%	4.0	3.5	5.0	5.0	2.5	1K1	500
	RCER72A474K2K1H03B	X7R	100	0.47μF	±10%	5.5	4.0	6.0	5.0	3.15	2K1	500
	RCER72A684K2K1H03B	X7R	100	0.68μF	±10%	5.5	4.0	6.0	5.0	3.15	2K1	500
	RCER72A105K2K1H03B	X7R	100	1.0μF	±10%	5.5	4.0	6.0	5.0	3.15	2K1	500
	RCEC72A155K3K1H03B	X7S	100	1.5μF	±10%	5.5	5.0	7.5	5.0	4.0	3K1	500
	RCEC72A225K3K1H03B	X7S	100	2.2μF	±10%	5.5	5.0	7.5	5.0	4.0	3K1	500
	RCEC72A475MWWK1H03B	X7S	100	4.7μF	±20%	5.5	7.5	10.0	5.0	4.0	WK1	500

• Straight Taping
(Lead Style:D*)

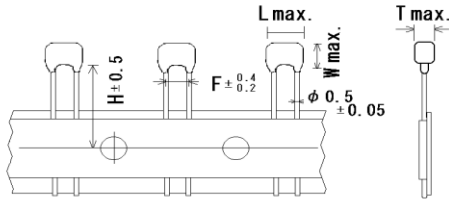

Unit : mm

Customer Part Number	Murata Part Number	T.C.	DC Rated Volt. (V)	Cap.	Cap. Tol.	Dimension (mm)						Dimension (LxW) Lead Style	Pack qty. (pcs)
						L	W	W1	F	T	H/H0		
	RCER71E104K0DBH03A	X7R	25	0.1μF	±10%	3.6	3.5	-	2.5	2.5	16.0	0DB	2000
	RCER71E154K0DBH03A	X7R	25	0.15μF	±10%	3.6	3.5	-	2.5	2.5	16.0	0DB	2000
	RCER71E224K0DBH03A	X7R	25	0.22μF	±10%	3.6	3.5	-	2.5	2.5	16.0	0DB	2000
	RCER71E334K1DBH03A	X7R	25	0.33μF	±10%	4.0	3.5	-	2.5	2.5	16.0	1DB	2000
	RCER71E474K1DBH03A	X7R	25	0.47μF	±10%	4.0	3.5	-	2.5	2.5	16.0	1DB	2000
	RCER71E684K1DBH03A	X7R	25	0.68μF	±10%	4.0	3.5	-	2.5	2.5	16.0	1DB	2000
	RCER71E105K1DBH03A	X7R	25	1.0μF	±10%	4.0	3.5	-	2.5	2.5	16.0	1DB	2000
	RCER71E155K2DBH03A	X7R	25	1.5μF	±10%	5.5	4.0	-	2.5	3.15	16.0	2DB	2000
	RCER71E225K2DBH03A	X7R	25	2.2μF	±10%	5.5	4.0	-	2.5	3.15	16.0	2DB	2000
	RCER71E335K2DBH03A	X7R	25	3.3μF	±10%	5.5	4.0	-	2.5	3.15	16.0	2DB	2000
	RCER71E475K2DBH03A	X7R	25	4.7μF	±10%	5.5	4.0	-	2.5	3.15	16.0	2DB	2000
	RCER71E106K3DBH03A	X7R	25	10μF	±10%	5.5	5.0	-	2.5	4.0	16.0	3DB	1500
	RCER71H221K0DBH03A	X7R	50	220pF	±10%	3.6	3.5	-	2.5	2.5	16.0	0DB	2000
	RCER71H331K0DBH03A	X7R	50	330pF	±10%	3.6	3.5	-	2.5	2.5	16.0	0DB	2000
	RCER71H471K0DBH03A	X7R	50	470pF	±10%	3.6	3.5	-	2.5	2.5	16.0	0DB	2000
	RCER71H681K0DBH03A	X7R	50	680pF	±10%	3.6	3.5	-	2.5	2.5	16.0	0DB	2000
	RCER71H102K0DBH03A	X7R	50	1000pF	±10%	3.6	3.5	-	2.5	2.5	16.0	0DB	2000
	RCER71H152K0DBH03A	X7R	50	1500pF	±10%	3.6	3.5	-	2.5	2.5	16.0	0DB	2000
	RCER71H222K0DBH03A	X7R	50	2200pF	±10%	3.6	3.5	-	2.5	2.5	16.0	0DB	2000
	RCER71H332K0DBH03A	X7R	50	3300pF	±10%	3.6	3.5	-	2.5	2.5	16.0	0DB	2000
	RCER71H472K0DBH03A	X7R	50	4700pF	±10%	3.6	3.5	-	2.5	2.5	16.0	0DB	2000
	RCER71H682K0DBH03A	X7R	50	6800pF	±10%	3.6	3.5	-	2.5	2.5	16.0	0DB	2000
	RCER71H103K0DBH03A	X7R	50	10000pF	±10%	3.6	3.5	-	2.5	2.5	16.0	0DB	2000
	RCER71H153K0DBH03A	X7R	50	15000pF	±10%	3.6	3.5	-	2.5	2.5	16.0	0DB	2000
	RCER71H223K0DBH03A	X7R	50	22000pF	±10%	3.6	3.5	-	2.5	2.5	16.0	0DB	2000
	RCER71H333K0DBH03A	X7R	50	33000pF	±10%	3.6	3.5	-	2.5	2.5	16.0	0DB	2000
	RCER71H473K0DBH03A	X7R	50	47000pF	±10%	3.6	3.5	-	2.5	2.5	16.0	0DB	2000
	RCER71H683K0DBH03A	X7R	50	68000pF	±10%	3.6	3.5	-	2.5	2.5	16.0	0DB	2000
	RCER71H104K0DBH03A	X7R	50	0.1μF	±10%	3.6	3.5	-	2.5	2.5	16.0	0DB	2000
	RCER71H154K1DBH03A	X7R	50	0.15μF	±10%	4.0	3.5	-	2.5	2.5	16.0	1DB	2000
	RCER71H224K1DBH03A	X7R	50	0.22μF	±10%	4.0	3.5	-	2.5	2.5	16.0	1DB	2000
	RCER71H334K1DBH03A	X7R	50	0.33μF	±10%	4.0	3.5	-	2.5	2.5	16.0	1DB	2000
	RCER71H474K1DBH03A	X7R	50	0.47μF	±10%	4.0	3.5	-	2.5	2.5	16.0	1DB	2000
	RCER71H684K2DBH03A	X7R	50	0.68μF	±10%	5.5	4.0	-	2.5	3.15	16.0	2DB	2000
	RCEC71H105K1DBH03A	X7S	50	1.0μF	±10%	4.0	3.5	-	2.5	2.5	16.0	1DB	2000
	RCER71H105K2DBH03A	X7R	50	1.0μF	±10%	5.5	4.0	-	2.5	3.15	16.0	2DB	2000
	RCER71H155K2DBH03A	X7R	50	1.5μF	±10%	5.5	4.0	-	2.5	3.15	16.0	2DB	2000
	RCER71H225K2DBH03A	X7R	50	2.2μF	±10%	5.5	4.0	-	2.5	3.15	16.0	2DB	2000
	RCER71H335K3DBH03A	X7R	50	3.3μF	±10%	5.5	5.0	-	2.5	4.0	16.0	3DB	1500
	RCEC71H475K2DBH03A	X7S	50	4.7μF	±10%	5.5	4.0	-	2.5	3.15	16.0	2DB	2000

• Straight Taping
(Lead Style: D*)

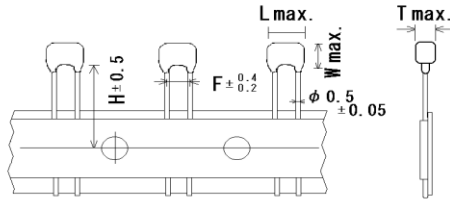

• Inside Crimp Taping
(Lead Style: M*)

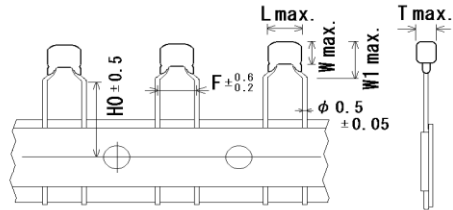

Unit : mm

Customer Part Number	Murata Part Number	T.C.	DC Rated Volt. (V)	Cap.	Cap. Tol.	Dimension (mm)						Dimension (LxW) Lead Style	Pack qty. (pcs)
						L	W	W1	F	T	H/H0		
	RCER71H475K3DBH03A	X7R	50	4.7µF	±10%	5.5	5.0	-	2.5	4.0	16.0	3DB	1500
	RCEC71H106K3DBH03A	X7S	50	10µF	±10%	5.5	5.0	-	2.5	4.0	16.0	3DB	1500
	RCER72A221K0DBH03A	X7R	100	220pF	±10%	3.6	3.5	-	2.5	2.5	16.0	0DB	2000
	RCER72A331K0DBH03A	X7R	100	330pF	±10%	3.6	3.5	-	2.5	2.5	16.0	0DB	2000
	RCER72A471K0DBH03A	X7R	100	470pF	±10%	3.6	3.5	-	2.5	2.5	16.0	0DB	2000
	RCER72A681K0DBH03A	X7R	100	680pF	±10%	3.6	3.5	-	2.5	2.5	16.0	0DB	2000
	RCER72A102K0DBH03A	X7R	100	1000pF	±10%	3.6	3.5	-	2.5	2.5	16.0	0DB	2000
	RCER72A152K0DBH03A	X7R	100	1500pF	±10%	3.6	3.5	-	2.5	2.5	16.0	0DB	2000
	RCER72A222K0DBH03A	X7R	100	2200pF	±10%	3.6	3.5	-	2.5	2.5	16.0	0DB	2000
	RCER72A332K0DBH03A	X7R	100	3300pF	±10%	3.6	3.5	-	2.5	2.5	16.0	0DB	2000
	RCER72A472K0DBH03A	X7R	100	4700pF	±10%	3.6	3.5	-	2.5	2.5	16.0	0DB	2000
	RCER72A682K0DBH03A	X7R	100	6800pF	±10%	3.6	3.5	-	2.5	2.5	16.0	0DB	2000
	RCER72A103K0DBH03A	X7R	100	10000pF	±10%	3.6	3.5	-	2.5	2.5	16.0	0DB	2000
	RCER72A153K0DBH03A	X7R	100	15000pF	±10%	3.6	3.5	-	2.5	2.5	16.0	0DB	2000
	RCER72A223K0DBH03A	X7R	100	22000pF	±10%	3.6	3.5	-	2.5	2.5	16.0	0DB	2000
	RCER72A333K1DBH03A	X7R	100	33000pF	±10%	4.0	3.5	-	2.5	2.5	16.0	1DB	2000
	RCER72A473K1DBH03A	X7R	100	47000pF	±10%	4.0	3.5	-	2.5	2.5	16.0	1DB	2000
	RCER72A683K1DBH03A	X7R	100	68000pF	±10%	4.0	3.5	-	2.5	2.5	16.0	1DB	2000
	RCER72A104K1DBH03A	X7R	100	0.1µF	±10%	4.0	3.5	-	2.5	2.5	16.0	1DB	2000
	RCER72A154K2DBH03A	X7R	100	0.15µF	±10%	5.5	4.0	-	2.5	3.15	16.0	2DB	2000
	RCER72A224K2DBH03A	X7R	100	0.22µF	±10%	5.5	4.0	-	2.5	3.15	16.0	2DB	2000
	RCER72A334K1DBH03A	X7R	100	0.33µF	±10%	4.0	3.5	-	2.5	2.5	16.0	1DB	2000
	RCER72A474K2DBH03A	X7R	100	0.47µF	±10%	5.5	4.0	-	2.5	3.15	16.0	2DB	2000
	RCER72A684K2DBH03A	X7R	100	0.68µF	±10%	5.5	4.0	-	2.5	3.15	16.0	2DB	2000
	RCER72A105K2DBH03A	X7R	100	1.0µF	±10%	5.5	4.0	-	2.5	3.15	16.0	2DB	2000
	RCEC72A155K3DBH03A	X7S	100	1.5µF	±10%	5.5	5.0	-	2.5	4.0	16.0	3DB	1500
	RCEC72A225K3DBH03A	X7S	100	2.2µF	±10%	5.5	5.0	-	2.5	4.0	16.0	3DB	1500
	RCER71E104K0M1H03A	X7R	25	0.1µF	±10%	3.6	3.5	6.0	5.0	2.5	16.0	0M1	2000
	RCER71E154K0M1H03A	X7R	25	0.15µF	±10%	3.6	3.5	6.0	5.0	2.5	16.0	0M1	2000
	RCER71E224K0M1H03A	X7R	25	0.22µF	±10%	3.6	3.5	6.0	5.0	2.5	16.0	0M1	2000
	RCER71E334K1M1H03A	X7R	25	0.33µF	±10%	4.0	3.5	5.0	5.0	2.5	16.0	1M1	2000
	RCER71E474K1M1H03A	X7R	25	0.47µF	±10%	4.0	3.5	5.0	5.0	2.5	16.0	1M1	2000
	RCER71E684K1M1H03A	X7R	25	0.68µF	±10%	4.0	3.5	5.0	5.0	2.5	16.0	1M1	2000
	RCER71E105K1M1H03A	X7R	25	1.0µF	±10%	4.0	3.5	5.0	5.0	2.5	16.0	1M1	2000
	RCER71E155K2M1H03A	X7R	25	1.5µF	±10%	5.5	4.0	6.0	5.0	3.15	16.0	2M1	2000
	RCER71E225K2M1H03A	X7R	25	2.2µF	±10%	5.5	4.0	6.0	5.0	3.15	16.0	2M1	2000
	RCER71E335K2M1H03A	X7R	25	3.3µF	±10%	5.5	4.0	6.0	5.0	3.15	16.0	2M1	2000
	RCER71E475K2M1H03A	X7R	25	4.7µF	±10%	5.5	4.0	6.0	5.0	3.15	16.0	2M1	2000
	RCER71E106K3M1H03A	X7R	25	10µF	±10%	5.5	5.0	7.5	5.0	4.0	16.0	3M1	1500
	RCER71E226MWM1H03A	X7R	25	22µF	±20%	5.5	7.5	10.0	5.0	4.0	16.0	WM1	1500

• Inside Crimp Taping
(Lead Style: M*)

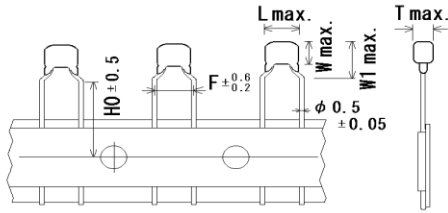

Unit : mm

Customer Part Number	Murata Part Number	T.C.	DC Rated Volt. (V)	Cap.	Cap. Tol.	Dimension (mm)						Dimension (LxW) Lead Style	Pack qty. (pcs)
						L	W	W1	F	T	H/H0		
	RCER71H221K0M1H03A	X7R	50	220pF	±10%	3.6	3.5	6.0	5.0	2.5	16.0	0M1	2000
	RCER71H331K0M1H03A	X7R	50	330pF	±10%	3.6	3.5	6.0	5.0	2.5	16.0	0M1	2000
	RCER71H471K0M1H03A	X7R	50	470pF	±10%	3.6	3.5	6.0	5.0	2.5	16.0	0M1	2000
	RCER71H681K0M1H03A	X7R	50	680pF	±10%	3.6	3.5	6.0	5.0	2.5	16.0	0M1	2000
	RCER71H102K0M1H03A	X7R	50	1000pF	±10%	3.6	3.5	6.0	5.0	2.5	16.0	0M1	2000
	RCER71H152K0M1H03A	X7R	50	1500pF	±10%	3.6	3.5	6.0	5.0	2.5	16.0	0M1	2000
	RCER71H222K0M1H03A	X7R	50	2200pF	±10%	3.6	3.5	6.0	5.0	2.5	16.0	0M1	2000
	RCER71H332K0M1H03A	X7R	50	3300pF	±10%	3.6	3.5	6.0	5.0	2.5	16.0	0M1	2000
	RCER71H472K0M1H03A	X7R	50	4700pF	±10%	3.6	3.5	6.0	5.0	2.5	16.0	0M1	2000
	RCER71H682K0M1H03A	X7R	50	6800pF	±10%	3.6	3.5	6.0	5.0	2.5	16.0	0M1	2000
	RCER71H103K0M1H03A	X7R	50	10000pF	±10%	3.6	3.5	6.0	5.0	2.5	16.0	0M1	2000
	RCER71H153K0M1H03A	X7R	50	15000pF	±10%	3.6	3.5	6.0	5.0	2.5	16.0	0M1	2000
	RCER71H223K0M1H03A	X7R	50	22000pF	±10%	3.6	3.5	6.0	5.0	2.5	16.0	0M1	2000
	RCER71H333K0M1H03A	X7R	50	33000pF	±10%	3.6	3.5	6.0	5.0	2.5	16.0	0M1	2000
	RCER71H473K0M1H03A	X7R	50	47000pF	±10%	3.6	3.5	6.0	5.0	2.5	16.0	0M1	2000
	RCER71H683K0M1H03A	X7R	50	68000pF	±10%	3.6	3.5	6.0	5.0	2.5	16.0	0M1	2000
	RCER71H104K0M1H03A	X7R	50	0.1μF	±10%	3.6	3.5	6.0	5.0	2.5	16.0	0M1	2000
	RCER71H154K1M1H03A	X7R	50	0.15μF	±10%	4.0	3.5	5.0	5.0	2.5	16.0	1M1	2000
	RCER71H224K1M1H03A	X7R	50	0.22μF	±10%	4.0	3.5	5.0	5.0	2.5	16.0	1M1	2000
	RCER71H334K1M1H03A	X7R	50	0.33μF	±10%	4.0	3.5	5.0	5.0	2.5	16.0	1M1	2000
	RCER71H474K1M1H03A	X7R	50	0.47μF	±10%	4.0	3.5	5.0	5.0	2.5	16.0	1M1	2000
	RCER71H684K2M1H03A	X7R	50	0.68μF	±10%	5.5	4.0	6.0	5.0	3.15	16.0	2M1	2000
	RCEC71H105K1M1H03A	X7S	50	1.0μF	±10%	4.0	3.5	5.0	5.0	2.5	16.0	1M1	2000
	RCER71H105K2M1H03A	X7R	50	1.0μF	±10%	5.5	4.0	6.0	5.0	3.15	16.0	2M1	2000
	RCER71H155K2M1H03A	X7R	50	1.5μF	±10%	5.5	4.0	6.0	5.0	3.15	16.0	2M1	2000
	RCER71H225K2M1H03A	X7R	50	2.2μF	±10%	5.5	4.0	6.0	5.0	3.15	16.0	2M1	2000
	RCER71H335K3M1H03A	X7R	50	3.3μF	±10%	5.5	5.0	7.5	5.0	4.0	16.0	3M1	1500
	RCEC71H475K2M1H03A	X7S	50	4.7μF	±10%	5.5	4.0	6.0	5.0	3.15	16.0	2M1	2000
	RCER71H475K3M1H03A	X7R	50	4.7μF	±10%	5.5	5.0	7.5	5.0	4.0	16.0	3M1	1500
	RCEC71H106K3M1H03A	X7S	50	10μF	±10%	5.5	5.0	7.5	5.0	4.0	16.0	3M1	1500
	RCER71H106MWM1H03A	X7R	50	10μF	±20%	5.5	7.5	10.0	5.0	4.0	16.0	WM1	1500
	RCEC71H226MWM1H03A	X7S	50	22μF	±20%	5.5	7.5	10.0	5.0	4.0	16.0	WM1	1500
	RCER72A221K0M1H03A	X7R	100	220pF	±10%	3.6	3.5	6.0	5.0	2.5	16.0	0M1	2000
	RCER72A331K0M1H03A	X7R	100	330pF	±10%	3.6	3.5	6.0	5.0	2.5	16.0	0M1	2000
	RCER72A471K0M1H03A	X7R	100	470pF	±10%	3.6	3.5	6.0	5.0	2.5	16.0	0M1	2000
	RCER72A681K0M1H03A	X7R	100	680pF	±10%	3.6	3.5	6.0	5.0	2.5	16.0	0M1	2000
	RCER72A102K0M1H03A	X7R	100	1000pF	±10%	3.6	3.5	6.0	5.0	2.5	16.0	0M1	2000
	RCER72A152K0M1H03A	X7R	100	1500pF	±10%	3.6	3.5	6.0	5.0	2.5	16.0	0M1	2000
	RCER72A222K0M1H03A	X7R	100	2200pF	±10%	3.6	3.5	6.0	5.0	2.5	16.0	0M1	2000
	RCER72A332K0M1H03A	X7R	100	3300pF	±10%	3.6	3.5	6.0	5.0	2.5	16.0	0M1	2000

• Inside Crimp Taping
(Lead Style: M*)

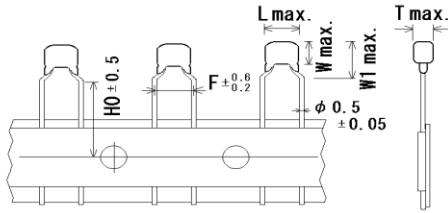

Unit : mm

Customer Part Number	Murata Part Number	T.C.	DC Rated Volt. (V)	Cap.	Cap. Tol.	Dimension (mm)						Dimension (LxW) Lead Style	Pack qty. (pcs)
						L	W	W1	F	T	H/H0		
	RCER72A472K0M1H03A	X7R	100	4700pF	±10%	3.6	3.5	6.0	5.0	2.5	16.0	0M1	2000
	RCER72A682K0M1H03A	X7R	100	6800pF	±10%	3.6	3.5	6.0	5.0	2.5	16.0	0M1	2000
	RCER72A103K0M1H03A	X7R	100	10000pF	±10%	3.6	3.5	6.0	5.0	2.5	16.0	0M1	2000
	RCER72A153K0M1H03A	X7R	100	15000pF	±10%	3.6	3.5	6.0	5.0	2.5	16.0	0M1	2000
	RCER72A223K0M1H03A	X7R	100	22000pF	±10%	3.6	3.5	6.0	5.0	2.5	16.0	0M1	2000
	RCER72A333K1M1H03A	X7R	100	33000pF	±10%	4.0	3.5	5.0	5.0	2.5	16.0	1M1	2000
	RCER72A473K1M1H03A	X7R	100	47000pF	±10%	4.0	3.5	5.0	5.0	2.5	16.0	1M1	2000
	RCER72A683K1M1H03A	X7R	100	68000pF	±10%	4.0	3.5	5.0	5.0	2.5	16.0	1M1	2000
	RCER72A104K1M1H03A	X7R	100	0.1μF	±10%	4.0	3.5	5.0	5.0	2.5	16.0	1M1	2000
	RCER72A154K2M1H03A	X7R	100	0.15μF	±10%	5.5	4.0	6.0	5.0	3.15	16.0	2M1	2000
	RCER72A224K2M1H03A	X7R	100	0.22μF	±10%	5.5	4.0	6.0	5.0	3.15	16.0	2M1	2000
	RCER72A334K1M1H03A	X7R	100	0.33μF	±10%	4.0	3.5	5.0	5.0	2.5	16.0	1M1	2000
	RCER72A474K2M1H03A	X7R	100	0.47μF	±10%	5.5	4.0	6.0	5.0	3.15	16.0	2M1	2000
	RCER72A684K2M1H03A	X7R	100	0.68μF	±10%	5.5	4.0	6.0	5.0	3.15	16.0	2M1	2000
	RCER72A105K2M1H03A	X7R	100	1.0μF	±10%	5.5	4.0	6.0	5.0	3.15	16.0	2M1	2000
	RCEC72A155K3M1H03A	X7S	100	1.5μF	±10%	5.5	5.0	7.5	5.0	4.0	16.0	3M1	1500
	RCEC72A225K3M1H03A	X7S	100	2.2μF	±10%	5.5	5.0	7.5	5.0	4.0	16.0	3M1	1500
	RCEC72A475MWM1H03A	X7S	100	4.7μF	±20%	5.5	7.5	10.0	5.0	4.0	16.0	WM1	1500

Reference only

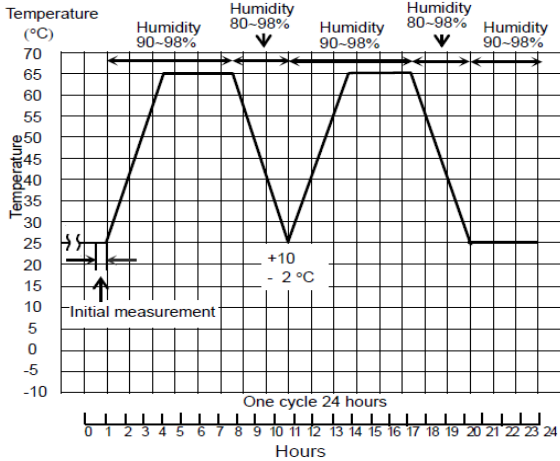
5. AEC-Q200 Murata Standard Specifications and Test Methods																			
No.	AEC-Q200 Test Item	Specification	AEC-Q200 Test Method																
1	Pre-and Post-Stress Electrical Test																		
2	High Temperature Exposure (Storage)	Appearance	No defects or abnormalities	Sit the capacitor for 1000±12h at 150±3°C. Let sit for 24±2h at *room condition then measure. •Pretreatment Perform the heat treatment at 150+0/-10°C for 60±5 min and then let sit for 24±2 h at *room condition.															
		Capacitance Change	within ±12.5%																
		D.F.	0.04 max.																
		I.R.	More than 1,000MΩ or 50 MΩ·μF (Whichever is smaller)																
3	Temperature Cycling	Appearance	No defects or abnormalities	Perform the 1000 cycles according to the four heat treatments listed in the following table. Let sit for 24±2 h at *room condition, then measure. <table border="1" style="margin: 10px auto;"> <thead> <tr> <th>Step</th> <th>1</th> <th>2</th> <th>3</th> <th>4</th> </tr> </thead> <tbody> <tr> <td>Temp. (°C)</td> <td>-55+0/-3</td> <td>Room Temp.</td> <td>125+3/-0</td> <td>Room Temp.</td> </tr> <tr> <td>Time (min.)</td> <td>15±3</td> <td>1</td> <td>15±3</td> <td>1</td> </tr> </tbody> </table> •Pretreatment Perform the heat treatment at 150+0/-10°C for 60±5 min and then let sit for 24±2 h at *room condition.	Step	1	2	3	4	Temp. (°C)	-55+0/-3	Room Temp.	125+3/-0	Room Temp.	Time (min.)	15±3	1	15±3	1
		Step	1		2	3	4												
		Temp. (°C)	-55+0/-3		Room Temp.	125+3/-0	Room Temp.												
		Time (min.)	15±3		1	15±3	1												
Capacitance Change	within ±12.5%																		
D.F.	0.05 max.																		
I.R.	1,000MΩ or 50MΩ·μF min. (Whichever is smaller)																		
4	Moisture Resistance	Appearance	No defects or abnormalities	Apply the 24h heat (25 to 65°C) and humidity (80 to 98%) treatment shown below, 10 consecutive times. Let sit for 24±2 h at *room condition, then measure. <div style="text-align: center;">  <p>The graph shows a 24-hour cycle. The temperature starts at 25°C, rises to 65°C at 4 hours, stays at 65°C until 8 hours, drops to 25°C at 10 hours, rises back to 65°C at 12 hours, stays at 65°C until 16 hours, drops to 25°C at 18 hours, and stays at 25°C until 24 hours. Humidity is 90-98% from 4 to 8 hours and 12 to 16 hours, and 80-98% from 8 to 12 hours and 16 to 20 hours. An initial measurement is taken at 2 hours. A temperature tolerance of +10/-2°C is indicated.</p> </div>															
		Capacitance Change	within ±12.5%																
		D.F.	0.05 max.																
		I.R.	500MΩ or 25MΩ·μF min. (Whichever is smaller)																
5	Biased Humidity	Appearance	No defects or abnormalities	Apply the rated voltage and DC1.3+0.2/-0V (add 100kΩ resistor) at 85±3°C and 80 to 85% humidity for 1000±12h. Remove and let sit for 24±2 h at *room condition, then measure. The charge/discharge current is less than 50mA. •Pretreatment Perform the heat treatment at 150+0/-10°C for 60±5 min and then let sit for 24±2 h at *room condition.															
		Capacitance Change	within ±12.5%																
		D.F.	0.05 max.																
		I.R.	500MΩ or 25MΩ·μF min. (Whichever is smaller)																
6	Operational Life	Appearance	No defects or abnormalities	Apply 200% of the rated voltage * 1 for 1000±12h at 125±3°C. Let sit for 24±2 h at *room condition, then measure. The charge/discharge current is less than 50mA. •Pretreatment Apply test voltage for 60±5 min at test temperature. Remove and let sit for 24±2 h at *room condition.															
		Capacitance Change	within ±12.5%																
		D.F.	0.04 max.																
		I.R.	1,000MΩ or 50MΩ·μF min. (Whichever is smaller)																

* "room condition" Temperature : 15 to 35°C, Relative humidity : 45 to 75%, Atmosphere pressure : 86 to 106kPa

* 1 : below parts are applicable in rated voltage×150%.

Char.	Rated Voltage	Capacitance	Dimensions
C7	1H	105	1
C7	1H	475	2
C7	1H	106	3
C7	1H	226	W
R7	2A	334	1
R7	2A	474-105	2
C7	2A	155-225	3
C7	2A	475	W

Reference only

No.	AEC-Q200 Test Item	Specification	AEC-Q200 Test Method									
7	External Visual	No defects or abnormalities	Visual inspection									
8	Physical Dimension	Within the specified dimensions	Using calipers and micrometers.									
9	Marking	To be easily legible.	Visual inspection									
10	Resistance to Solvents	Appearance	Per MIL-STD-202 Method 215 Solvent 1 : 1 part (by volume) of isopropyl alcohol 3 parts (by volume) of mineral spirits Solvent 2 : Terpene defluxer Solvent 3 : 42 parts (by volume) of water 1part (by volume) of propylene glycol monomethyl ether 1 part (by volume) of monoethanolamine									
		Capacitance										
		D.F.										
		I.R.										
		0.025 max.										
		More than 10,000MΩ or 500 MΩ·μF (Whichever is smaller)										
11	Mechanical Shock	Appearance	Three shocks in each direction should be applied along 3 mutually perpendicular axes of the test specimen (18 shocks). The specified test pulse should be Half-sine and should have a duration : 0.5ms, peak value : 1500G and velocity change : 4.7m/s.									
		Capacitance										
		D.F.										
		0.025 max.										
12	Vibration	Appearance	The capacitor should be subjected to a simple harmonic motion having a total amplitude of 1.5mm, the frequency being varied uniformly between the approximate limits of 10 and 2,000Hz. The frequency range, from 10 to 2000Hz and return to 10Hz, should be traversed in approximately 20 min. This motion should be applied for 12 items in each 3 mutually perpendicular directions (total of 36 times).									
		Capacitance										
		D.F.										
		0.025 max.										
13-1	Resistance to Soldering Heat (Non-Preheat)	Appearance	The lead wires should be immersed in the melted solder 1.5 to 2.0mm from the root of terminal at 260±5°C for 10±1 seconds. • Pre-treatment Capacitor should be stored at 150+0/-10°C for one hour, then place at *room condition for 24±2 hours before initial measurement. • Post-treatment Capacitor should be stored for 24±2 hours at *room condition.									
		Capacitance Change										
		Dielectric Strength (Between terminals)										
		No defects or abnormalities										
		Within ±7.5%										
		No defects										
13-2	Resistance to Soldering Heat (On-Preheat)	Appearance	First the capacitor should be stored at 120+0/-5°C for 60+0/-5 seconds. Then, the lead wires should be immersed in the melted solder 1.5 to 2.0mm from the root of terminal at 260±5°C for 7.5+0/-1 seconds. • Pre-treatment Capacitor should be stored at 150+0/-10°C for one hour, then place at *room condition for 24±2 hours before initial measurement. • Post-treatment Capacitor should be stored for 24±2 hours at *room condition.									
		Capacitance Change										
		Dielectric Strength (Between terminals)										
		No defects or abnormalities										
		Within ±7.5%										
		No defects										
13-3	Resistance to Soldering Heat (soldering iron method)	Appearance	Test condition Temperature of iron-tip : 350±10°C Soldering time : 3.5±0.5 seconds Soldering position Straight Lead : 1.5 to 2.0mm from the root of terminal. Crimp Lead : 1.5 to 2.0mm from the end of lead bend. • Pre-treatment Capacitor should be stored at 150+0/-10°C for one hour, then place at *room condition for 24±2 hours before initial measurement. • Post-treatment Capacitor should be stored for 24±2 hours at *room condition.									
		Capacitance Change										
		Dielectric Strength (Between terminals)										
		No defects or abnormalities										
		Within ±7.5%										
		No defects										
14	Thermal Shock	Appearance	Perform the 300 cycles according to the two heat treatments listed in the following table(Maximum transfer time is 20s.). Let sit for 24±2 h at *room condition, then measure.									
		Capacitance Change										
		D.F.										
		I.R.										
		0.05 max.										
		1,000MΩ or 50MΩ·μF min. (Whichever is smaller)										
			<table border="1"> <thead> <tr> <th>Step</th> <th>1</th> <th>2</th> </tr> </thead> <tbody> <tr> <td>Temp. (°C)</td> <td>-55+0/-3</td> <td>125+3/-0</td> </tr> <tr> <td>Time (min.)</td> <td>15±3</td> <td>15±3</td> </tr> </tbody> </table>	Step	1	2	Temp. (°C)	-55+0/-3	125+3/-0	Time (min.)	15±3	15±3
Step	1	2										
Temp. (°C)	-55+0/-3	125+3/-0										
Time (min.)	15±3	15±3										
			•Pretreatment Perform the heat treatment at 150+0/-10°C for 60±5 min and then let sit for 24±2 h at *room condition.									

*"room condition" Temperature : 15 to 35°C, Relative humidity : 45 to 75%, Atmosphere pressure : 86 to 106kPa

Reference only

No.	AEC-Q200 Test Item		Specifications		AEC-Q200 Test Method												
15	ESD	Appearance	No defects or abnormalities		Per AEC-Q200-002												
		Capacitance	Within the specified tolerance														
		D.F.	0.025 max.														
		I.R.	More than 10,000MΩ or 500 MΩ·μF (Whichever is smaller)														
16	Solderability		Lead wire should be soldered with uniform coating on the axial direction over 95% of the circumferential direction.		Should be placed into steam aging for 8h±15 min. The terminal of capacitor is dipped into a solution of ethanol (JIS K 8101) and rosin (JIS K 5902) (25% rosin in weight propotion). Immerse in solder solution for 2±0.5 seconds. In both cases the depth of dipping is up to about 1.5 to 2mm from the terminal body. Temp. of solder : 245±5°C Lead Free Solder(Sn-3.0Ag-0.5Cu) 235±5°C H60A or H63A Eutectic Solder												
17	Electrical Characterization	Appearance	No defects or abnormalities		Visual inspection.												
		Capacitance	Within the specified tolerance		The capacitance/D.F. should be measured at 25°C at the frequency and voltage shown in the table.												
		D.F.	0.025 max.														
		I.R.	Between Terminals	10,000MΩ or 500MΩ·μF min. (Whichever is smaller)		The insulation resistance should be measured with a DC voltage not exceeding the rated voltage at 25 °C within 2 min. of charging.											
		Dielectric Strength	Between Terminals	No defects or abnormalities		The capacitor should not be damaged when DC voltage of 250% of the rated voltage is applied between the terminations for 1 to 5 seconds. (Charge/Discharge current ≤ 50mA.)											
			Body Insulation	No defects or abnormalities		The capacitor is placed in a container with metal balls of 1mm diameter so that each terminal, short-circuit is kept approximately 2mm from the balls, and 250% of the rated DC voltage is impressed for 1 to 5 seconds between capacitor terminals and metal balls. (Charge/Discharge current ≤ 50mA.)											
18	Terminal Strength	Tensile Strength	Termination not to be broken or loosened		As in the figure, fix the capacitor body, apply the force gradually to each lead in the radial direction of the capacitor until reaching 10N and then keep the force applied for 10±1 seconds. 												
		Bending Strength	Termination not to be broken or loosened		Each lead wire should be subjected to a force of 2.5N and then be bent 90° at the point of egress in one direction. Each wire is then returned to the original position and bent 90° in the opposite direction at the rate of one bend per 2 to 3 seconds.												
19	Capacitance Temperature Characteristics		Char.X7R : Within ±15% Char.X7S : Within ±22%		The capacitance change should be measured after 5min. at each specified temperature step. <table border="1" data-bbox="954 1460 1197 1630"> <thead> <tr> <th>Step</th> <th>Temperature(°C)</th> </tr> </thead> <tbody> <tr> <td>1</td> <td>25±2</td> </tr> <tr> <td>2</td> <td>-55±3</td> </tr> <tr> <td>3</td> <td>25±2</td> </tr> <tr> <td>4</td> <td>125±3</td> </tr> <tr> <td>5</td> <td>25±2</td> </tr> </tbody> </table> The ranges of capacitance change compared with the above 25°C value over the temperature ranges shown in the table should be within the specified ranges. •Pretreatment Perform the heat treatment at 150+0/-10°C for 60±5 min and then let sit for 24±2 h at *room condition. Perform the initial measurement.	Step	Temperature(°C)	1	25±2	2	-55±3	3	25±2	4	125±3	5	25±2
Step	Temperature(°C)																
1	25±2																
2	-55±3																
3	25±2																
4	125±3																
5	25±2																
* "room condition" Temperature : 15 to 35°C, Relative humidity : 45 to 75%, Atmosphere pressure : 86 to 106kPa																	

6. Packing specification

- Bulk type (Packing style code : B)

The size of packing case and packing way

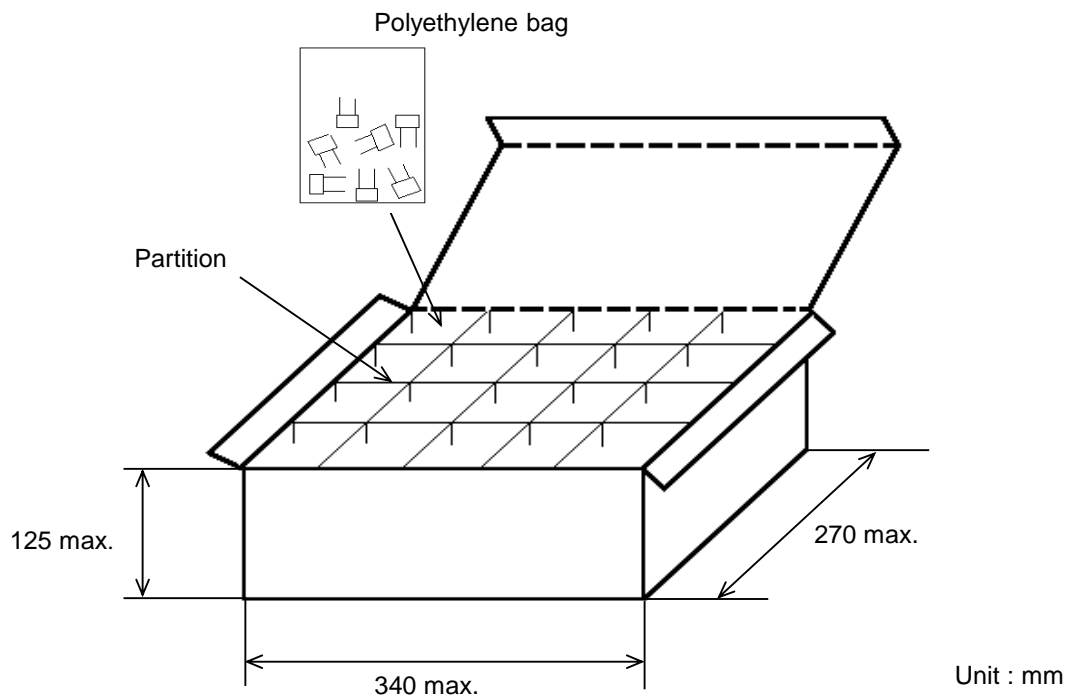

The number of packing = ^{*1} Packing quantity × ^{*2} n

*1 : Please refer to [Part number list].

*2 : Standard n = 20 (bag)

Note)

The outer package and the number of outer packing be changed by the order getting amount.

• Ammo pack taping type (Packing style code : A)

A crease is made every 25 pitches, and the tape with capacitors is packed zigzag into a case. When body of the capacitor is piled on other body under it.

The size of packing case and packing way

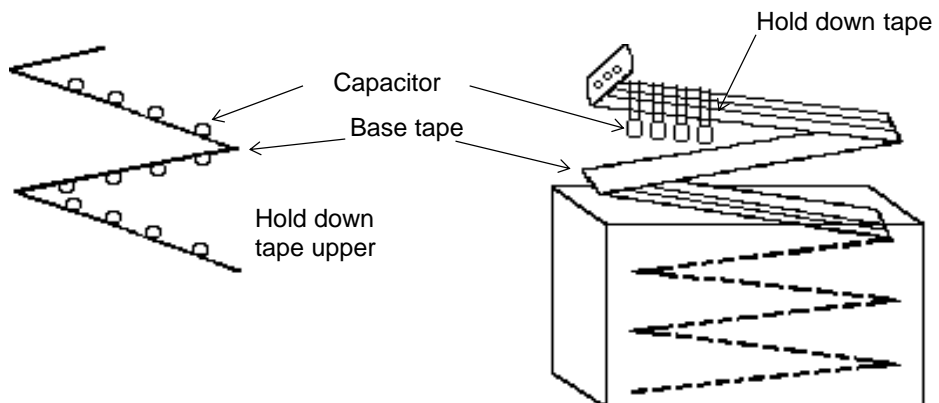
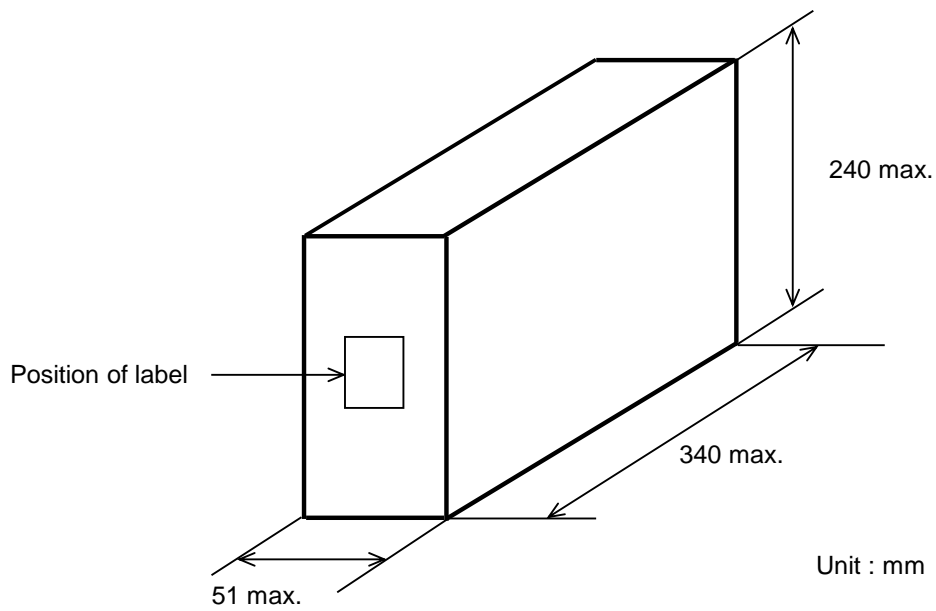

7. Taping specification

7-1. Dimension of capacitors on tape

Straight taping type < Lead Style : DB >

Pitch of component 12.7mm / Lead spacing 2.5mm

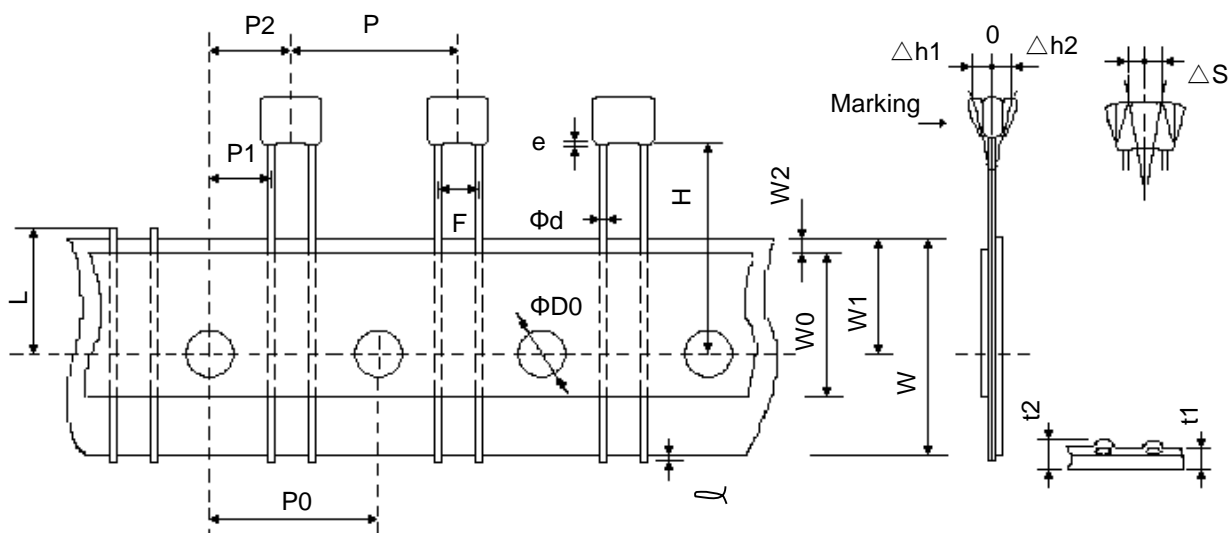

Unit : mm

Item	Code	Dimensions	Remarks
Pitch of component	P	12.7+/-1.0	
Pitch of sprocket hole	P0	12.7+/-0.2	
Lead spacing	F	2.5+0.4/-0.2	
Length from hole center to component center	P2	6.35+/-1.3	Deviation of progress direction
Length from hole center to lead	P1	5.1+/-0.7	
Deviation along tape, left or right defect	ΔS	0+/-2.0	They include deviation by lead bend
Carrier tape width	W	18.0+/-0.5	
Position of sprocket hole	W1	9.0+0/-0.5	Deviation of tape width direction
Lead distance between reference and bottom plane	H	16.0+/-0.5	
Protrusion length	ℓ	0.5 max.	
Diameter of sprocket hole	ΦD0	4.0+/-0.1	
Lead diameter	Φd	0.5+/-0.05	
Total tape thickness	t1	0.6+/-0.3	They include hold down tape thickness
Total thickness of tape and lead wire	t2	1.5 max.	
Deviation across tape	Δh1	1.0 max.	
	Δh2		
Portion to cut in case of defect	L	11.0+0/-1.0	
Hold down tape width	W0	9.5 min.	
Hold down tape position	W2	1.5+/-1.5	
Coating extension on lead	e	1.5 max.	

Reference only

Inside crimp taping type < Lead Style : M1 >
 Pitch of component 12.7mm / Lead spacing 5.0mm

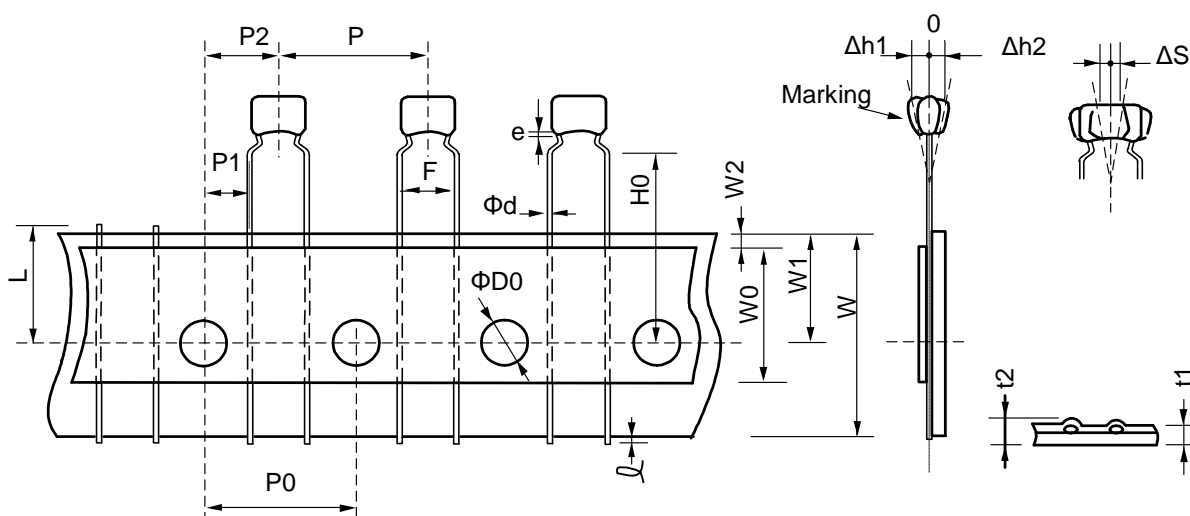

Unit : mm

Item	Code	Dimensions	Remarks
Pitch of component	P	12.7+/-1.0	
Pitch of sprocket hole	P0	12.7+/-0.2	
Lead spacing	F	5.0+0.6/-0.2	
Length from hole center to component center	P2	6.35+/-1.3	Deviation of progress direction
Length from hole center to lead	P1	3.85+/-0.7	
Deviation along tape, left or right defect	ΔS	0+/-2.0	They include deviation by lead bend
Carrier tape width	W	18.0+/-0.5	
Position of sprocket hole	W1	9.0+0/-0.5	Deviation of tape width direction
Lead distance between reference and bottom plane	H0	16.0+/-0.5	
Protrusion length	ℓ	0.5 max.	
Diameter of sprocket hole	ΦD0	4.0+/-0.1	
Lead diameter	Φd	0.5+/-0.05	
Total tape thickness	t1	0.6+/-0.3	They include hold down tape thickness
Total thickness of tape and lead wire	t2	1.5 max.	
Deviation across tape	Δh1	2.0 max. (Dimension code : W)	
	Δh2	1.0 max. (except as above)	
Portion to cut in case of defect	L	11.0+0/-1.0	
Hold down tape width	W0	9.5 min.	
Hold down tape position	W2	1.5+/-1.5	
Coating extension on lead	e	Up to the end of crimp	

7-2. Splicing way of tape

- 1) Adhesive force of tape is over 3N at test condition as below.

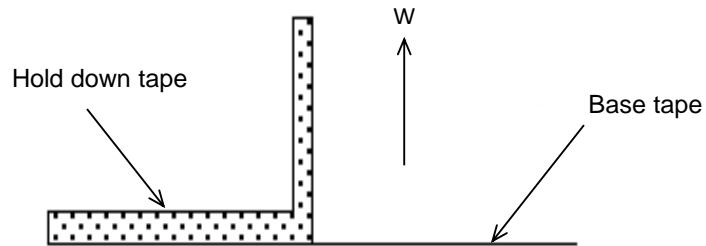

- 2) Splicing of tape

- a) When base tape is spliced

- Base tape shall be spliced by cellophane tape.
- (Total tape thickness shall be less than 1.05mm.)

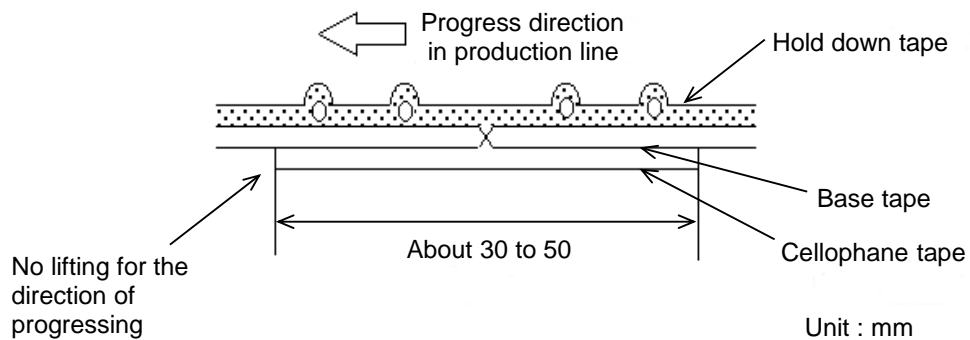

- b) When hold down tape is spliced

- Hold down tape shall be spliced with overlapping.
- (Total tape thickness shall be less than 1.05mm.)

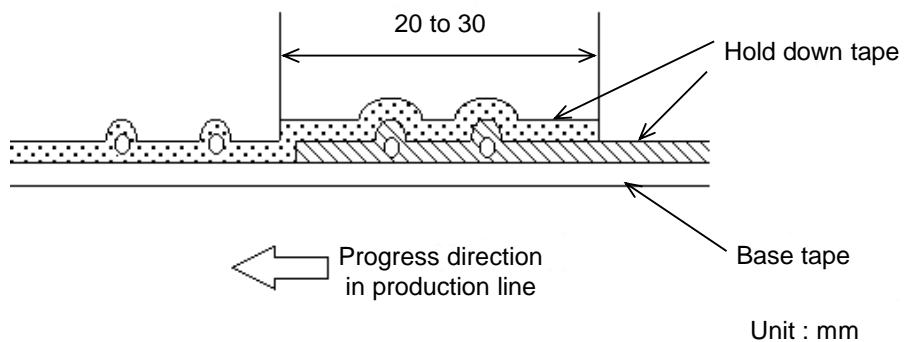

- c) When both tape are spliced

- Base tape and hold down tape shall be spliced with splicing tape.