



EFM32 Series 0: Introduction



EFM32 Series 0 Training

Topic

EFM32 Intro
Tools, projects and IDEs
Intro to EFM32 API
Interrupts and Energy Modes

Flash Programming and Debug Interface
Bootloaders

Hardware Design
Analog Peripherals
Serial Communication Peripherals

Displays and the External Bus Interface
DMA
PRS
Timers and Counters

Low Energy Sensor Interface (LESENSE)
Energy Optimization
Third-party Software and Tools

EFM32 Intro

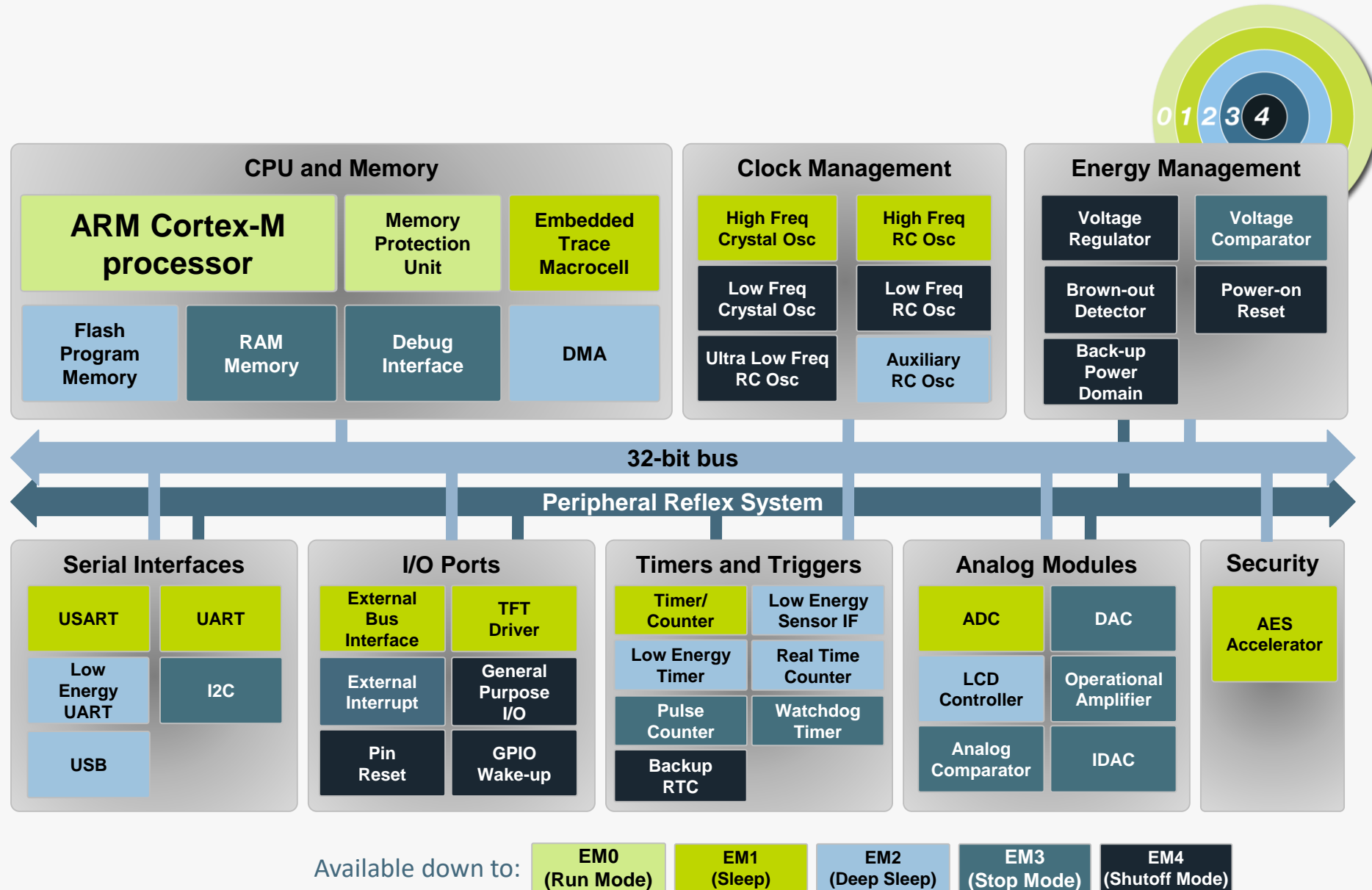

Clocks and Oscillators

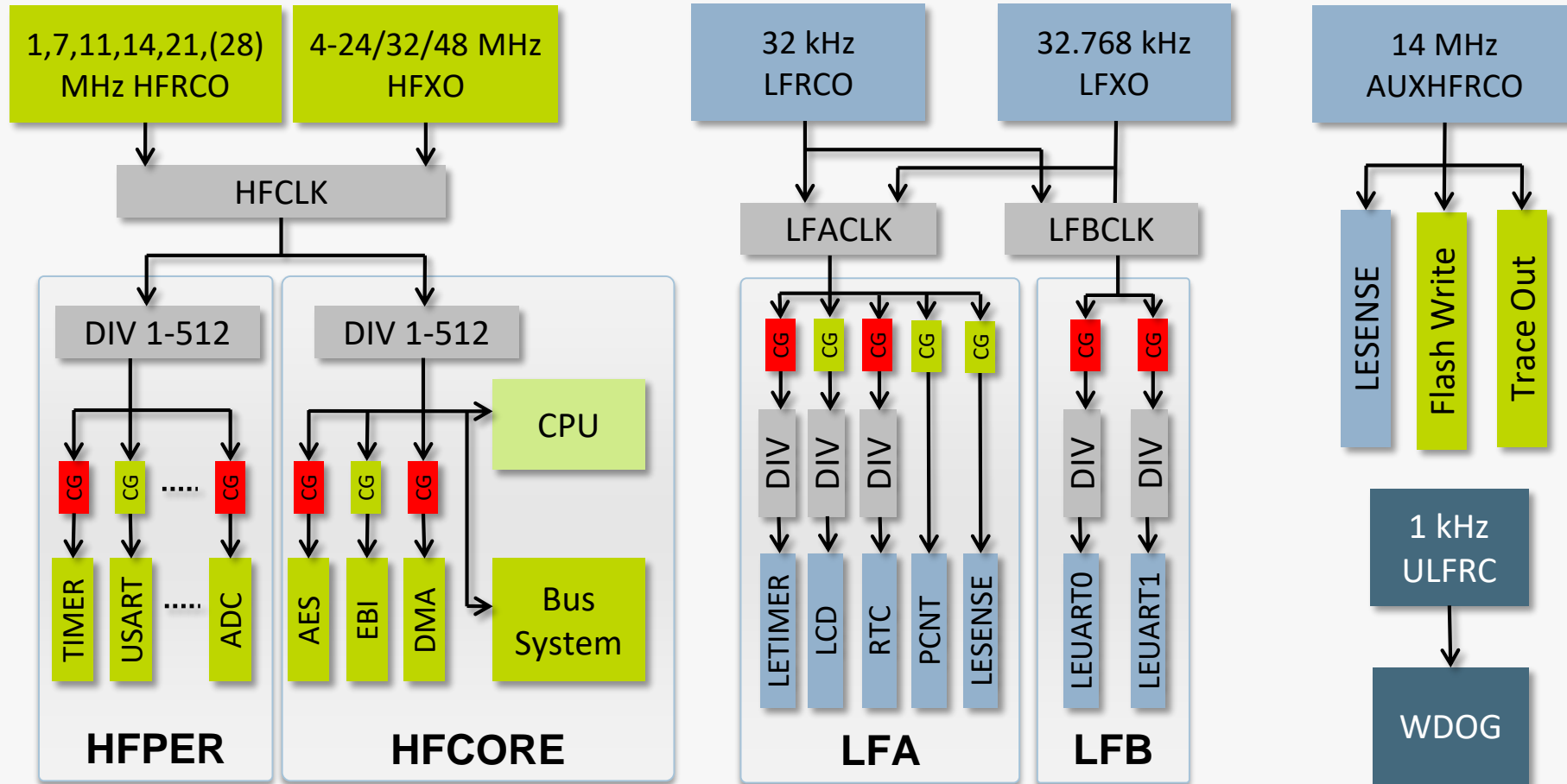

Current Part Numbers

Software compatible

Pin compatible within each package

Series	Sub-Series	Optional Features	QFN24	QFN32	QFN64	QFP48	QFP64	QFP100	BGA48	BGA112	BGA120
M4	Wonder	USB LCD TFT DSP with FPU			EFM32WG940		EFM32WG942	EFM32WG980		EFM32WG990	EFM32WG995
					EFM32WG330		EFM32WG332	EFM32WG380		EFM32WG390	EFM32WG395
M3	Giant	USB LCD TFT			EFM32GG840	Pin compatible	EFM32GG842	EFM32GG880		EFM32GG890	EFM32GG895
					EFM32GG230		EFM32GG232	EFM32GG280	EFM32GG290	EFM32GG295	
M3	Leopard	USB LCD TFT			EFM32LG840		EFM32LG842	EFM32LG880		EFM32LG890	EFM32LG895
					EFM32LG230	EFM32LG232	EFM32LG280	EFM32LG290	EFM32LG295		
M0+	Gecko	LCD		EFM32G210	EFM32G840		EFM32G842	EFM32G880		EFM32G890	
				EFM32G200	EFM32G230	EFM32G222	EFM32G232	EFM32G280	EFM32G290		
M0+	Tiny	LCD	EFM32TG110		EFM32TG840	EFM32TG822	EFM32TG842		EFM32TG825		
			EFM32TG108	EFM32TG210	EFM32TG230	EFM32TG222	EFM32TG232	EFM32TG225			
M0+	Zero		EFM32ZG110								
			EFM32ZG108	EFM32ZG210		EFM32ZG222					



Up to 32 MHz
Flash: 4 - 32
RAM: 2 - 4



Up to 32 MHz
Flash: 4 - 32
RAM: 2 - 4



Up to 32 MHz
Flash: 16 - 128
RAM: 8 - 16



Up to 48 MHz
Flash: 64 - 256
RAM: 32





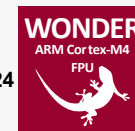



Up to 48 MHz
Flash: 512 - 1024
RAM: 128



Up to 48 MHz
Flash: 64 - 256
RAM: 32

LINKS

Kits

	\$30	\$30	\$30	\$30	\$300	\$349
	Zero Gecko Starter Kit	Gecko Starter Kit	Tiny Gecko Starter Kit	Leopard/Giant/Wonder Gecko Starter Kit	Gecko Development Kit	Leopard/Giant/Wonder Gecko Development Kit
						
Kit Part Number	EFM32ZG-STK3200	EFM32G-G8XX-STK	EFM32TG-STK3300	EFM32LG-STK3600 EFM32GG-STK3700 EFM32WG-STK3800	EFM32G-DK3550	EFM32LG-DK3650 EFM32GG-DK3750 EFM32WG-DK3850
Device	EFM32ZG222F32	EFM32G890F128	EFM32TG840F32	EFM32LG990F256 EFM32WG990F256 EFM32GG990F1024	EFM32G890F128	EFM32LG990F256 EFM32WG990F256 EFM32GG990F1024
Advanced Energy Monitoring	Yes	Yes	Yes	Yes	Yes	Yes
USB J-Link Debugger	Yes	Yes	Yes	Yes	Yes	Yes
Plug-in MCU and prototyping board	-	-	-	-	Yes	Yes
Onboard J-Trace	-	-	-	-	-	Yes
Screen	128x128 pixel MemoryLCD	4x40 segment LCD	8x20 segment LCD	8x20 segment LCD	4x40 segment LCD 320x240 RGB TFT w/touch	320x240 RGB TFT w/touch