

MJL21193 (PNP), MJL21194 (NPN)

Silicon Power Transistors

The MJL21193 and MJL21194 utilize Perforated Emitter technology and are specifically designed for high power audio output, disk head positioners and linear applications.

Features

- Total Harmonic Distortion Characterized
- High DC Current Gain
- Excellent Gain Linearity
- High SOA
- These Devices are Pb-Free and are RoHS Compliant*

MAXIMUM RATINGS

Rating	Symbol	Value	Unit
Collector-Emitter Voltage	V_{CEO}	250	Vdc
Collector-Base Voltage	V_{CBO}	400	Vdc
Emitter-Base Voltage	V_{EBO}	5	Vdc
Collector-Emitter Voltage - 1.5 V	V_{CEX}	400	Vdc
Collector Current - Continuous	I_C	16	Adc
Collector Current - Peak (Note 1)	I_{CM}	30	Adc
Base Current - Continuous	I_B	5	Adc
Total Power Dissipation @ $T_C = 25^\circ\text{C}$ Derate above 25°C	P_D	200 1.43	W W/ $^\circ\text{C}$
Operating and Storage Junction Temperature Range	T_J, T_{stg}	-65 to +150	$^\circ\text{C}$

Stresses exceeding Maximum Ratings may damage the device. Maximum Ratings are stress ratings only. Functional operation above the Recommended Operating Conditions is not implied. Extended exposure to stresses above the Recommended Operating Conditions may affect device reliability.

1. Pulse Test: Pulse Width = 300 μs , Duty Cycle $\leq 2\%$

THERMAL CHARACTERISTICS

Characteristic	Symbol	Max	Unit
Thermal Resistance, Junction-to-Case	$R_{\theta JC}$	0.7	$^\circ\text{C}/\text{W}$

*For additional information on our Pb-Free strategy and soldering details, please download the ON Semiconductor Soldering and Mounting Techniques Reference Manual, SOLDERRM/D.



ON Semiconductor®

<http://onsemi.com>

16 AMPERE COMPLEMENTARY SILICON POWER TRANSISTORS 250 VOLTS, 200 WATTS

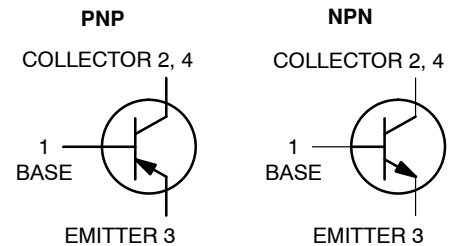

MARKING DIAGRAM

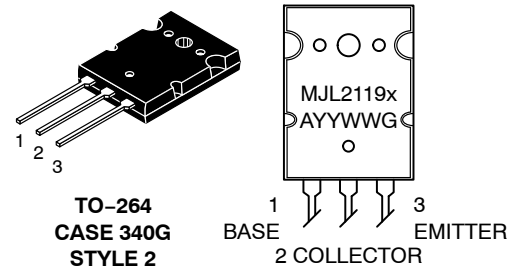

x = 3 or 4
A = Assembly Location
YY = Year
WW = Work Week
G = Pb-Free Package

ORDERING INFORMATION

Device	Package	Shipping†
MJL21193G	TO-264 (Pb-Free)	25 Units / Rail
MJL21194G	TO-264 (Pb-Free)	25 Units / Rail

†For information on tape and reel specifications, including part orientation and tape sizes, please refer to our Tape and Reel Packaging Specifications Brochure, BRD8011/D.

MJL21193 (PNP), MJL21194 (NPN)

ELECTRICAL CHARACTERISTICS ($T_C = 25^\circ\text{C}$ unless otherwise noted)

Characteristic	Symbol	Min	Typ	Max	Unit
----------------	--------	-----	-----	-----	------

OFF CHARACTERISTICS

Collector–Emitter Sustaining Voltage ($I_C = 100\text{ mAdc}$, $I_B = 0$)	$V_{CE(sus)}$	250	–	–	Vdc
Collector Cutoff Current ($V_{CE} = 200\text{ Vdc}$, $I_B = 0$)	I_{CEO}	–	–	100	μA dc
Emitter Cutoff Current ($V_{CE} = 5\text{ Vdc}$, $I_C = 0$)	I_{EBO}	–	–	100	μA dc
Collector Cutoff Current ($V_{CE} = 250\text{ Vdc}$, $V_{BE(off)} = 1.5\text{ Vdc}$)	I_{CEX}	–	–	100	μA dc

SECOND BREAKDOWN

Second Breakdown Collector Current with Base Forward Biased ($V_{CE} = 50\text{ Vdc}$, $t = 1\text{ s}$ (non-repetitive)) ($V_{CE} = 80\text{ Vdc}$, $t = 1\text{ s}$ (non-repetitive))	$I_{S/b}$	4.0 2.25	– –	– –	A
---	-----------	-------------	--------	--------	---

ON CHARACTERISTICS

DC Current Gain ($I_C = 8\text{ A}$ dc, $V_{CE} = 5\text{ Vdc}$) ($I_C = 16\text{ A}$ dc, $I_B = 5\text{ A}$ dc)	h_{FE}	25 8	– –	75 –	
Base–Emitter On Voltage ($I_C = 8\text{ A}$ dc, $V_{CE} = 5\text{ Vdc}$)	$V_{BE(on)}$	–	–	2.2	Vdc
Collector–Emitter Saturation Voltage ($I_C = 8\text{ A}$ dc, $I_B = 0.8\text{ A}$ dc) ($I_C = 16\text{ A}$ dc, $I_B = 3.2\text{ A}$ dc)	$V_{CE(sat)}$	– –	– –	1.4 4	Vdc

DYNAMIC CHARACTERISTICS

Total Harmonic Distortion at the Output $V_{RMS} = 28.3\text{ V}$, $f = 1\text{ kHz}$, $P_{LOAD} = 100\text{ W}_{RMS}$ (Matched pair $h_{FE} = 50 @ 5\text{ A}/5\text{ V}$)	T_{HD}				%
h_{FE} unmatched		–	0.8	–	
h_{FE} matched		–	0.08	–	
Current Gain Bandwidth Product ($I_C = 1\text{ A}$ dc, $V_{CE} = 10\text{ Vdc}$, $f_{test} = 1\text{ MHz}$)	f_T	4	–	–	MHz
Output Capacitance ($V_{CB} = 10\text{ Vdc}$, $I_E = 0$, $f_{test} = 1\text{ MHz}$)	C_{ob}	–	–	500	pF

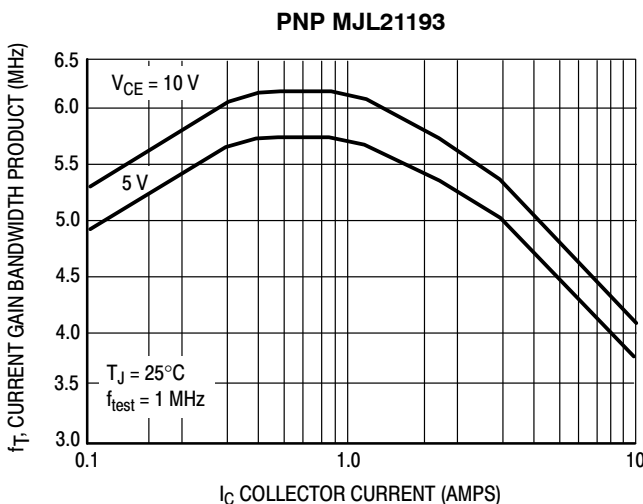

Figure 1. Typical Current Gain Bandwidth Product

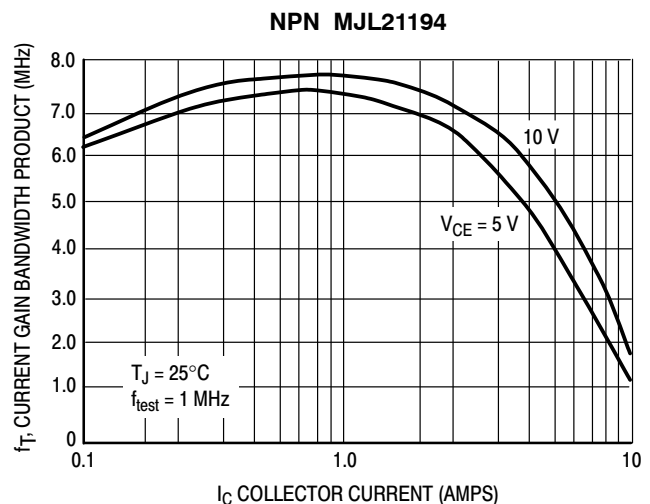

Figure 2. Typical Current Gain Bandwidth Product

MJL21193 (PNP), MJL21194 (NPN)

TYPICAL CHARACTERISTICS

PNP MJL21193

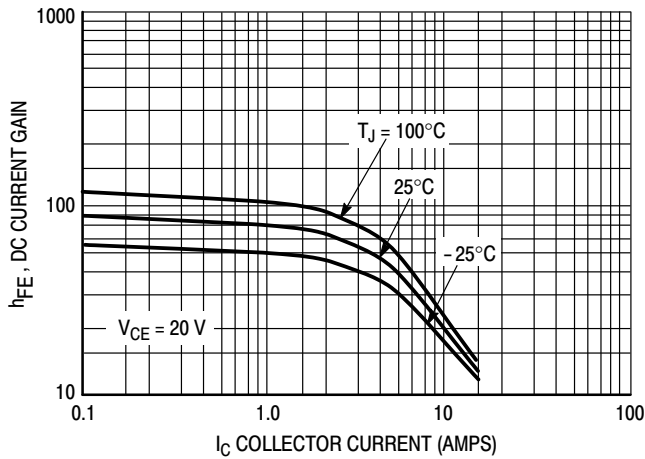

Figure 3. DC Current Gain, $V_{CE} = 20\text{ V}$

NPN MJL21194

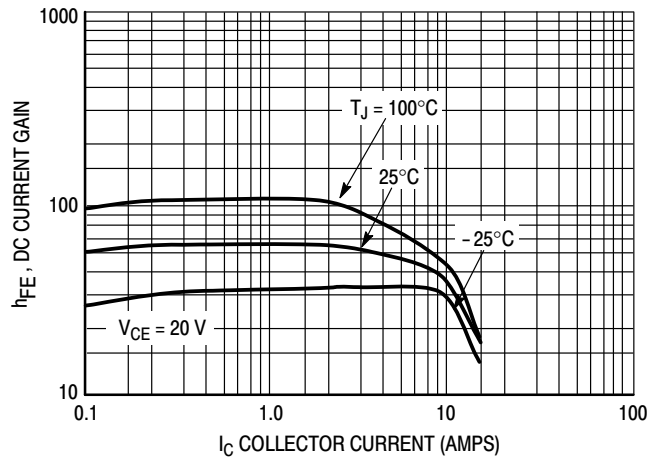

Figure 4. DC Current Gain, $V_{CE} = 20\text{ V}$

PNP MJL21193

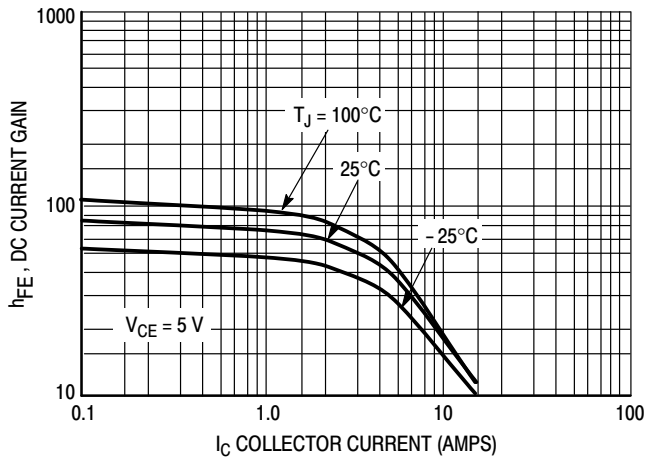

Figure 5. DC Current Gain, $V_{CE} = 5\text{ V}$

NPN MJL21194

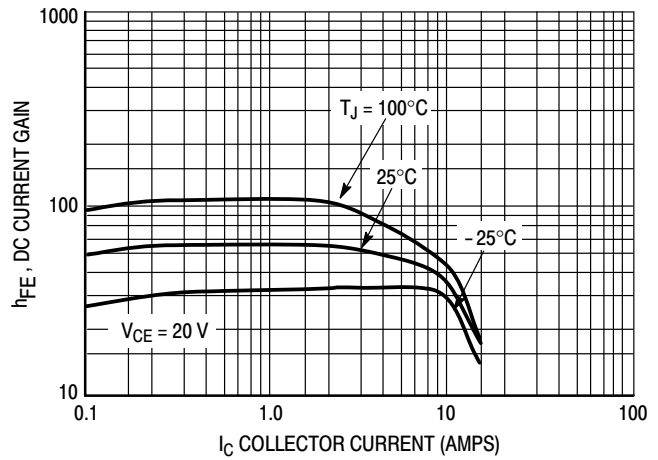

Figure 6. DC Current Gain, $V_{CE} = 5\text{ V}$

PNP MJL21193

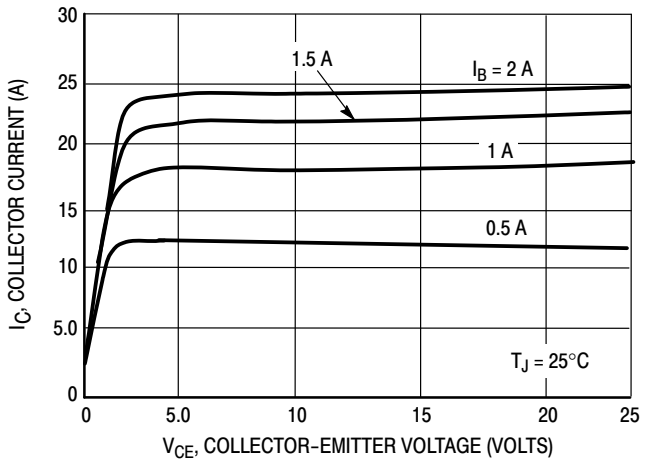

Figure 7. Typical Output Characteristics

NPN MJL21194

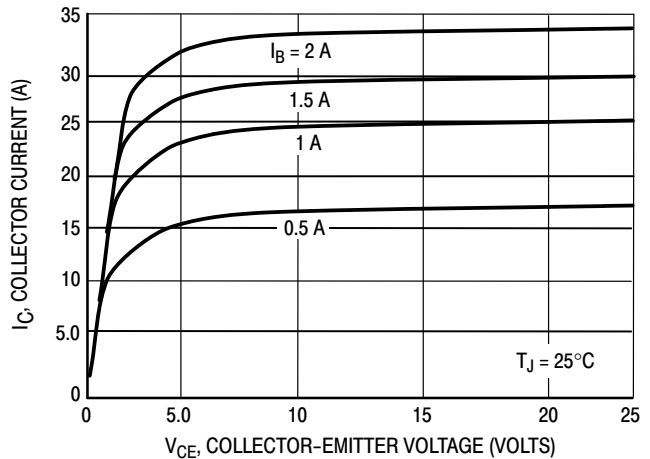

Figure 8. Typical Output Characteristics

MJL21193 (PNP), MJL21194 (NPN)

TYPICAL CHARACTERISTICS

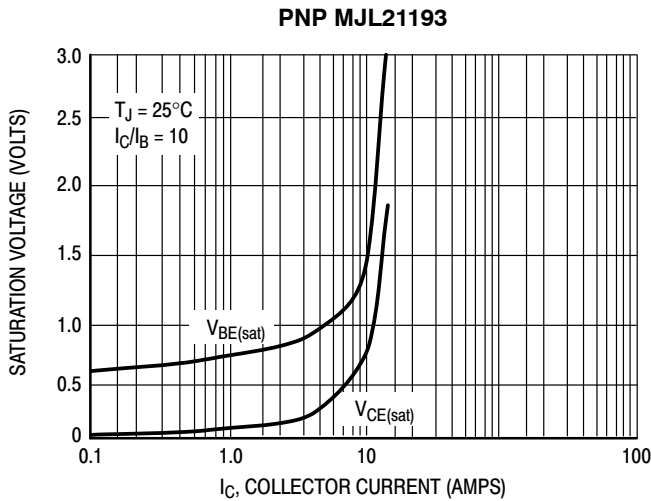

Figure 9. Typical Saturation Voltages

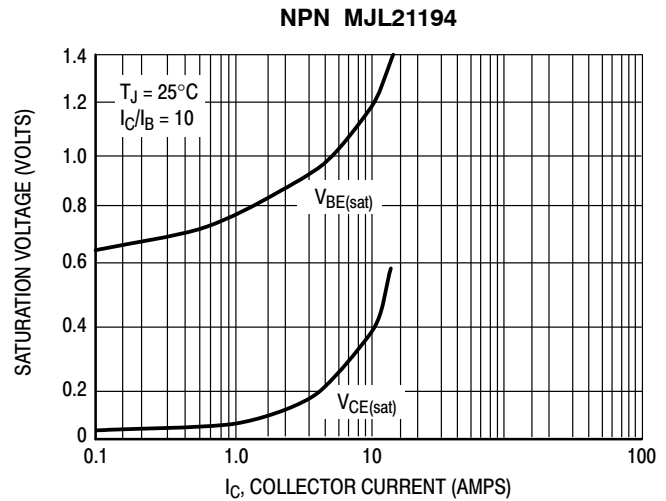

Figure 10. Typical Saturation Voltages

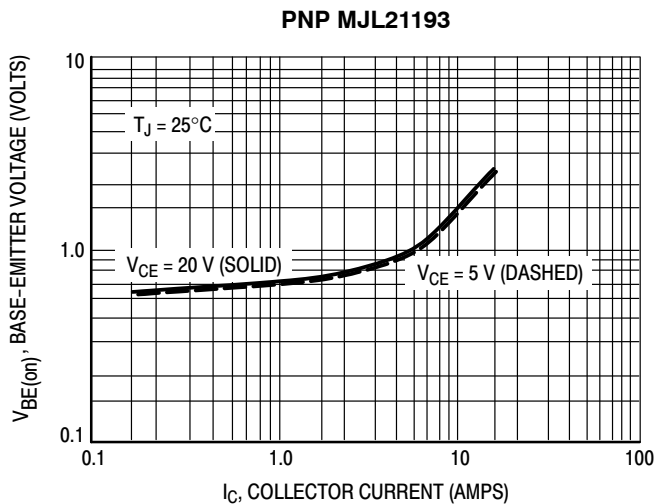

Figure 11. Typical Base-Emitter Voltage

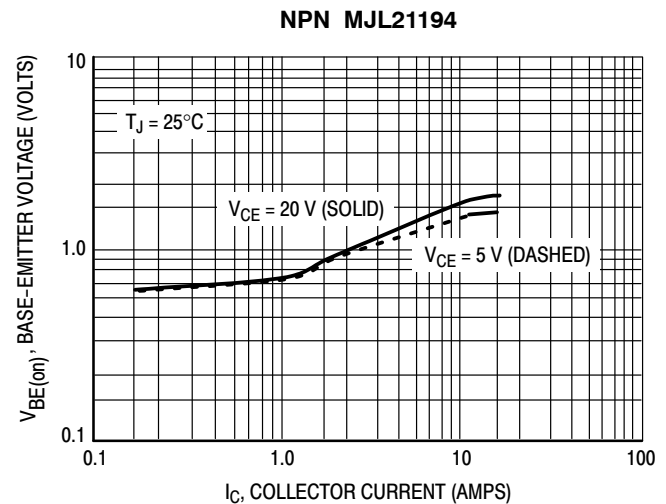

Figure 12. Typical Base-Emitter Voltage

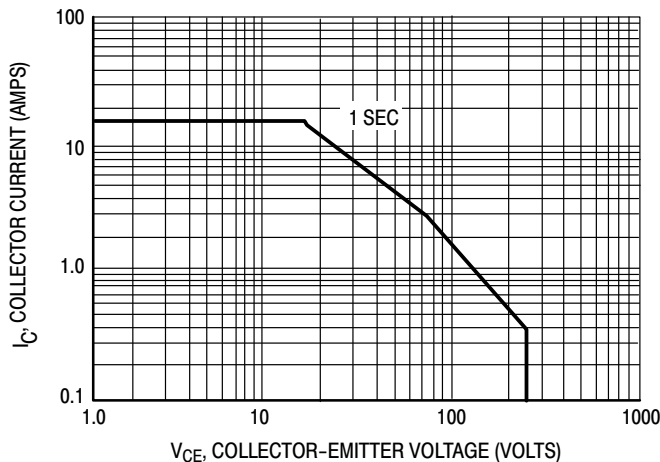

Figure 13. Active Region Safe Operating Area

There are two limitations on the power handling ability of a transistor; average junction temperature and secondary breakdown. Safe operating area curves indicate $I_C - V_{CE}$ limits of the transistor that must be observed for reliable operation; i.e., the transistor must not be subjected to greater dissipation than the curves indicate.

The data of Figure 13 is based on $T_{J(pk)} = 150^\circ\text{C}$; T_C is variable depending on conditions. At high case temperatures, thermal limitations will reduce the power than can be handled to values less than the limitations imposed by second breakdown.

MJL21193 (PNP), MJL21194 (NPN)

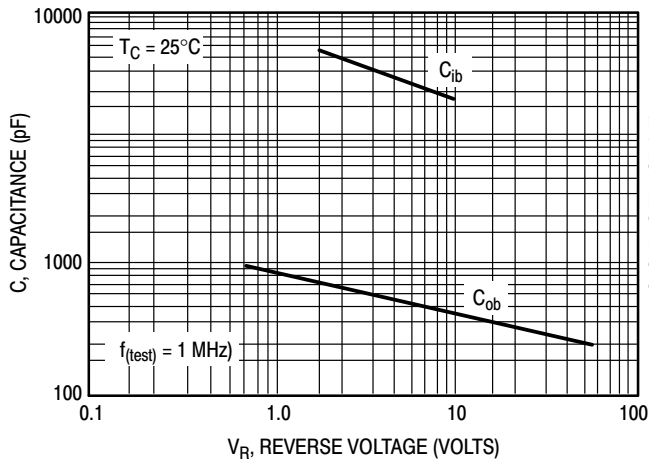

Figure 14. MJL21193 Typical Capacitance

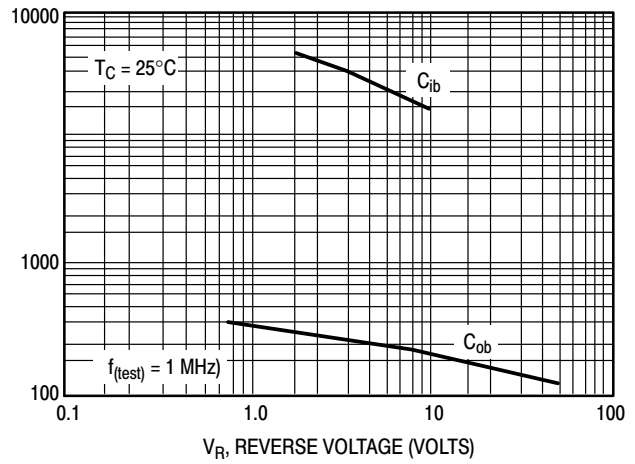

Figure 15. MJL21194 Typical Capacitance

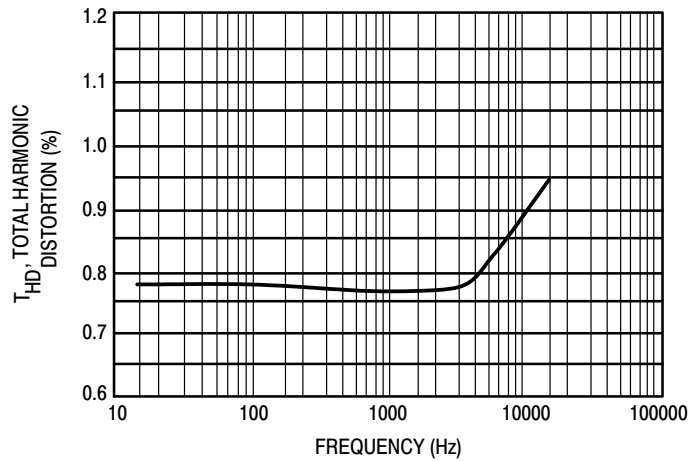

Figure 16. Typical Total Harmonic Distortion

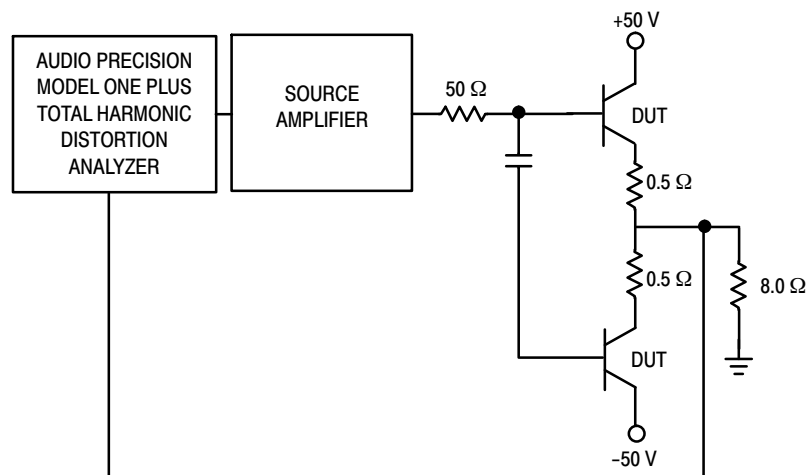
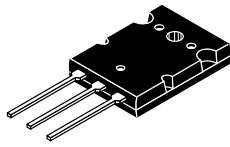

Figure 17. Total Harmonic Distortion Test Circuit

MECHANICAL CASE OUTLINE

PACKAGE DIMENSIONS

ON Semiconductor®



TO-3BPL (TO-264)
CASE 340G-02
ISSUE J

DATE 17 DEC 2004

SCALE 1:2

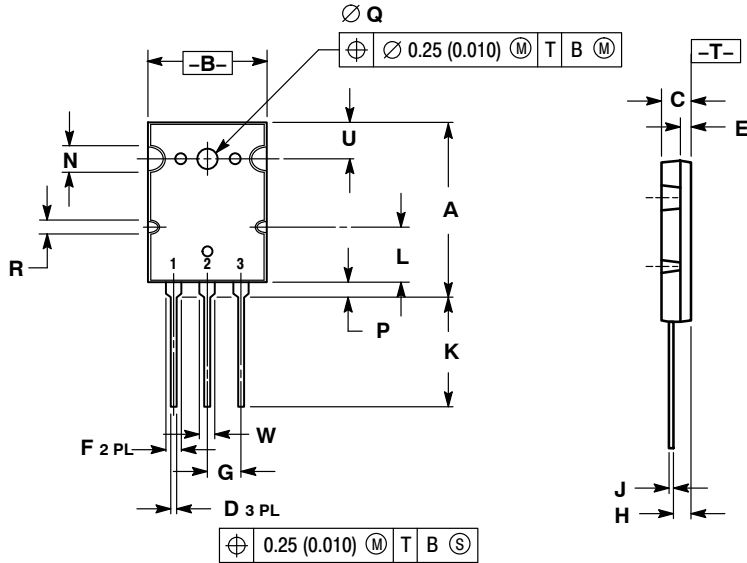

- NOTES:
1. DIMENSIONING AND TOLERANCING PER ANSI Y14.5M, 1982.
 2. CONTROLLING DIMENSION: MILLIMETER.

DIM	MILLIMETERS		INCHES	
	MIN	MAX	MIN	MAX
A	28.0	29.0	1.102	1.142
B	19.3	20.3	0.760	0.800
C	4.7	5.3	0.185	0.209
D	0.93	1.48	0.037	0.058
E	1.9	2.1	0.075	0.083
F	2.2	2.4	0.087	0.102
G	5.45 BSC		0.215 BSC	
H	2.6	3.0	0.102	0.118
J	0.43	0.78	0.017	0.031
K	17.6	18.8	0.693	0.740
L	11.2 REF		0.411 REF	
N	4.35 REF		0.172 REF	
P	2.2	2.6	0.087	0.102
Q	3.1	3.5	0.122	0.137
R	2.25 REF		0.089 REF	
U	6.3 REF		0.248 REF	
W	2.8	3.2	0.110	0.125

GENERIC MARKING DIAGRAM*

- | | | | | |
|--|---|--|--|---|
| STYLE 1:
PIN 1. GATE
2. DRAIN
3. SOURCE | STYLE 2:
PIN 1. BASE
2. COLLECTOR
3. EMITTER | STYLE 3:
PIN 1. GATE
2. SOURCE
3. DRAIN | STYLE 4:
PIN 1. DRAIN
2. SOURCE
3. GATE | STYLE 5:
PIN 1. GATE
2. COLLECTOR
3. EMITTER |
|--|---|--|--|---|

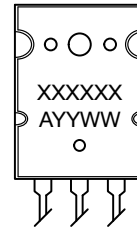

- XXXXXX = Specific Device Code
A = Location Code
YY = Year
WW = Work Week

*This information is generic. Please refer to device data sheet for actual part marking. Pb-Free indicator, "G" or microdot "▪", may or may not be present.

DOCUMENT NUMBER:	98ASB42780B	Electronic versions are uncontrolled except when accessed directly from the Document Repository. Printed versions are uncontrolled except when stamped "CONTROLLED COPY" in red.
DESCRIPTION:	TO-3BPL (TO-264)	PAGE 1 OF 1

ON Semiconductor and are trademarks of Semiconductor Components Industries, LLC dba ON Semiconductor or its subsidiaries in the United States and/or other countries. ON Semiconductor reserves the right to make changes without further notice to any products herein. ON Semiconductor makes no warranty, representation or guarantee regarding the suitability of its products for any particular purpose, nor does ON Semiconductor assume any liability arising out of the application or use of any product or circuit, and specifically disclaims any and all liability, including without limitation special, consequential or incidental damages. ON Semiconductor does not convey any license under its patent rights nor the rights of others.

onsemi, **Onsemi**, and other names, marks, and brands are registered and/or common law trademarks of Semiconductor Components Industries, LLC dba "**onsemi**" or its affiliates and/or subsidiaries in the United States and/or other countries. **onsemi** owns the rights to a number of patents, trademarks, copyrights, trade secrets, and other intellectual property. A listing of **onsemi**'s product/patent coverage may be accessed at www.onsemi.com/site/pdf/Patent-Marking.pdf. **onsemi** reserves the right to make changes at any time to any products or information herein, without notice. The information herein is provided "as-is" and **onsemi** makes no warranty, representation or guarantee regarding the accuracy of the information, product features, availability, functionality, or suitability of its products for any particular purpose, nor does **onsemi** assume any liability arising out of the application or use of any product or circuit, and specifically disclaims any and all liability, including without limitation special, consequential or incidental damages. Buyer is responsible for its products and applications using **onsemi** products, including compliance with all laws, regulations and safety requirements or standards, regardless of any support or applications information provided by **onsemi**. "Typical" parameters which may be provided in **onsemi** data sheets and/or specifications can and do vary in different applications and actual performance may vary over time. All operating parameters, including "Typicals" must be validated for each customer application by customer's technical experts. **onsemi** does not convey any license under any of its intellectual property rights nor the rights of others. **onsemi** products are not designed, intended, or authorized for use as a critical component in life support systems or any FDA Class 3 medical devices or medical devices with a same or similar classification in a foreign jurisdiction or any devices intended for implantation in the human body. Should Buyer purchase or use **onsemi** products for any such unintended or unauthorized application, Buyer shall indemnify and hold **onsemi** and its officers, employees, subsidiaries, affiliates, and distributors harmless against all claims, costs, damages, and expenses, and reasonable attorney fees arising out of, directly or indirectly, any claim of personal injury or death associated with such unintended or unauthorized use, even if such claim alleges that **onsemi** was negligent regarding the design or manufacture of the part. **onsemi** is an Equal Opportunity/Affirmative Action Employer. This literature is subject to all applicable copyright laws and is not for resale in any manner.

ADDITIONAL INFORMATION

TECHNICAL PUBLICATIONS:

Technical Library: www.onsemi.com/design/resources/technical-documentation
onsemi Website: www.onsemi.com

ONLINE SUPPORT: www.onsemi.com/support

For additional information, please contact your local Sales Representative at www.onsemi.com/support/sales