

The documentation and process conversion measures necessary to comply with this document shall be completed by 10 October 2019.

INCH-POUND

MIL-PRF-19500/291Y
w/AMENDMENT 1
10 July 2019
SUPERSEDING
MIL-PRF-19500/291Y
27 March 2019

PERFORMANCE SPECIFICATION SHEET

TRANSISTOR, PNP, SILICON, SWITCHING, DEVICE TYPES 2N2906A AND 2N2907A,
ENCAPSULATED (THROUGH HOLE AND SURFACE MOUNT PACKAGES) AND UNENCAPSULATED,
RADIATION HARDNESS ASSURANCE,
QUALITY LEVELS JAN, JANTX, JANTXV, JANS, JANHC, AND JANKC

This specification is approved for use by all Departments
and Agencies of the Department of Defense.

The requirements for acquiring the product described herein shall consist of
this specification sheet and [MIL-PRF-19500](#).

1. SCOPE

* 1.1 Scope. This specification covers the performance requirements for PNP, silicon, switching transistors. Four levels of product assurance (JAN, JANTX, JANTXV, and JANS) are provided for each encapsulated device type, and two levels of product assurance (JANHC and JANKC) are provided for each unencapsulated device, as specified in [MIL-PRF-19500](#). Provisions for radiation hardness assurance (RHA) to eight radiation levels is provided for quality levels JANTXV, JANS, JANHC, and JANKC.

1.2 Physical dimensions.

1.2.1 Package outlines. The device package outlines for the encapsulated device types are as follows: Three terminal round metal can TO-206AA (formerly TO-18) in accordance with [figure 1](#), four terminal surface mount device (SMD) package in accordance with [figure 2](#), and three or four terminal SMD package in accordance with [figure 3](#).

* 1.2.2 Unencapsulated die. The dimensions and topography for JANHC and JANKC unencapsulated die are as follows: The B version die (JANHCB and JANKCB) is in accordance with [figure 4](#), the D version die (JANHCD and JANKCD) is in accordance with [figure 5](#), and the E version die (JANHCE and JANKCE) is in accordance with [figure 6](#).

1.3 Maximum ratings. Unless otherwise specified $T_A = +25^\circ\text{C}$.

Types	I_C	V_{CBO}	V_{EBO}	V_{CEO}	T_J and T_{STG}
	<u>mA dc</u>	<u>V dc</u>	<u>V dc</u>	<u>V dc</u>	<u>°C</u>
All devices	-600	-60	-5	-60	-65 to +200

Comments, suggestions, or questions on this document should be addressed to DLA Land and Maritime, ATTN: VAC, P.O. Box 3990, Columbus, OH 43218-3990, or emailed to Semiconductor@dla.mil. Since contact information can change, you may want to verify the currency of this address information using the ASSIST Online database at <https://assist.dla.mil>.



MIL-PRF-19500/291Y
w/AMENDMENT 1

1.3 Maximum ratings. Unless otherwise specified $T_A = +25^\circ\text{C}$ - Continued.

Types	P_T $T_A = +25^\circ\text{C}$	P_T $T_C = +25^\circ\text{C}$	P_T $T_{SP(IS)} =$ $+25^\circ\text{C}$	P_T $T_{SP(AM)} =$ $+25^\circ\text{C}$	$R_{\theta JA}$	$R_{\theta JC}$	$R_{\theta JSP(IS)}$	$R_{\theta JSP(AM)}$
	(1) (2)	(1) (2)	(1) (2)	(1) (2)	(2) (3)	(2) (3)	(2) (3)	(2) (3)
	<u>W</u>	<u>W</u>	<u>W</u>	<u>W</u>	<u>°C/W</u>	<u>°C/W</u>	<u>°C/W</u>	<u>°C/W</u>
2N2906A, L,	0.5	1.0	N/A	N/A	325	150	N/A	N/A
2N2907A, L	0.5	1.0	N/A	N/A	325	150	N/A	N/A
2N2906AUA,	(4) 0.5	N/A	1.0	1.5	(4) 325	N/A	110	40
2N2907AUA	(4) 0.5	N/A	1.0	1.5	(4) 325	N/A	110	40
2N2906AUB, and UBN	(4) 0.5	N/A	1.0	N/A	(4) 325	N/A	90	N/A
2N2907AUB and UBN	(4) 0.5	N/A	1.0	N/A	(4) 325	N/A	90	N/A
2N2906AUBC and UBCN	(4) 0.5	N/A	1.0	N/A	(4) 325	N/A	90	N/A
2N2907AUBC and UBCN	(4) 0.5	N/A	1.0	N/A	(4) 325	N/A	90	N/A

- (1) For derating, see figure 7, figure 8, figure 9, figure 10, and figure 11.
- (2) See 3.3 for abbreviations.
- (3) For thermal curves, see figure 12, figure 13, figure 14, figure 15, and figure 16.
- (4) For non-thermal conductive PCB or unknown PCB surface mount conditions in free air, substitute figure 7 and figure 12 for the UA, UB, UBC, UBN, and UBCN package and use $R_{\theta JA}$.

1.4 Primary electrical characteristics. Unless otherwise specified $T_A = +25^\circ\text{C}$.

h _{FE} at V _{CE} = -10 V dc										
Limits (2) (3)	h _{FE1} I _C = -0.1 mA dc		h _{FE2} I _C = -1.0 mA dc		h _{FE3} I _C = -10 mA dc		h _{FE4} (1) I _C = -150 mA dc		h _{FE5} (1) I _C = -500 mA dc	
	(2)	(3)	(2)	(3)	(2)	(3)	(2)	(3)	(2)	(3)
Min	40	75	40	100	40	100	40	100	40	50
Max			175	450			120	300		

Limits (2) (3)	h _{fe} f = 100 MHz V _{CE} = -20 V dc, I _C = -20 mA dc	C _{obo} 100 kHz ≤ f ≤ 1 MHz V _{CB} = -10 V dc, I _E = 0	Switching (saturated)	
			t _{on} See figure 1	t _{off} See figure 1
Min	2.0	pF	ns	ns
Max			8	45

Limits (2) (3)	V _{CE(sat)1} (1) I _C = -150 mA dc I _B = -15 mA dc	V _{CE(sat)2} (1) I _C = -500 mA dc I _B = -50 mA dc	V _{BE(sat)1} (1) I _C = -150 mA dc I _B = -15 mA dc	V _{BE(sat)2} (1) I _C = -500 mA dc I _B = -50 mA dc
	<u>V dc</u>	<u>V dc</u>	<u>V dc</u>	<u>V dc</u>
Min			-0.6	
Max	-0.4	-1.6	-1.3	-2.6

- (1) Pulsed see 4.5.1.
- (2) Includes device type 2N2906A and package designators "L", "UA", "UB", "UBC", "UBN", and "UBCN".
- (3) Includes device type 2N2907A and package designators "L", "UA", "UB", "UBC", "UBN", and "UBCN".

MIL-PRF-19500/291Y
w/AMENDMENT 1

1.5 Part or Identifying Number (PIN). The PIN is in accordance with [MIL-PRF-19500](#) and as specified herein. See [6.5](#) for PIN construction example and [6.6](#) for a list of available PINs.

1.5.1 JAN certification mark and quality level designators.

1.5.1.1 Encapsulated devices. The quality level designators for encapsulated devices that are applicable for this specification sheet from the lowest to the highest level are as follows: "JAN", "JANTX", "JANTXV", and "JANS".

1.5.1.2 Unencapsulated die. The quality level designators for unencapsulated die that are applicable for this specification sheet from the lowest to the highest level are as follows: "JANHC" and "JANKC".

1.5.2 RHA designator. The RHA levels that are applicable for this specification sheet from lowest to highest for quality levels JANS and JANKC are as follows: "M", "D", "P", "L", "R", "F", "G", and "H".

1.5.3 Device type. The designation system for the device types covered by this specification sheet are as follows.

1.5.3.1 First number and first letter symbols. The semiconductors of this specification sheet use the first number and letter symbols "2N".

1.5.3.2 Second number symbols. The second number symbols for the semiconductors covered by this specification sheet are as follows: "2906" and "2907".

1.5.4 Suffix symbols. The following suffix letters are incorporated in the PIN for this specification sheet.

1.5.4.1 Modified version designator. All devices use an "A" suffix symbol that indicates an electrical parameter modified version of the device versus the non-suffix device. Non-A suffix devices are not covered by this specification.

1.5.4.2 Package designators. The suffix symbols (or lack thereof) that designate the package outline for the devices covered by this specification sheet are as follows:

Blank	A blank designator identifies that the package is a TO-206AA (see figure 1).
UA	This designator indicates a 4-terminal SMD package (see figure 2).
UB	This designator indicates a 4-terminal metal lid (used as a shield and connected to fourth pad) SMD package (see figure 3).
UBC	This designator indicates a 4-terminal ceramic lid (lid is braze-ring connected to fourth pad) SMD package (see figure 3).
UBN	This designator indicates a 3-terminal isolated metal lid SMD package (see figure 3).
UBCN	This designator indicates a 3-terminal isolated ceramic lid SMD package (see figure 3).

1.5.5 Lead finish. The lead finishes applicable to this specification sheet are listed on [QML-19500](#).

* 1.5.6 Die identifiers for unencapsulated devices. The manufacturer die identifiers that are applicable for this specification sheet are "B" (see [figure 4](#)), "D" (see [figure 5](#)), and "E" (see [figure 6](#)).

MIL-PRF-19500/291Y
w/AMENDMENT 1

Symbol	Dimensions				Notes
	Inches		Millimeters		
	Min	Max	Min	Max	
CD	.178	.195	4.52	4.95	4
CH	.170	.210	4.32	5.33	
HD	.209	.230	5.31	5.84	4
LC	.100 TP		2.54 TP		5
LD	.016	.021	0.41	0.53	6, 7
LL	.500	.750	12.70	19.05	6, 7, 8
LU	.016	.019	0.41	0.48	6, 7
L1		.050		1.27	6, 7
L2	.250		6.35		6, 7
P	.100		2.54		
Q		.030		0.76	4
TL	.028	.048	0.71	1.22	9
TW	.036	.046	0.91	1.17	10
r		.010		0.25	11
α	45° TP		45° TP		5

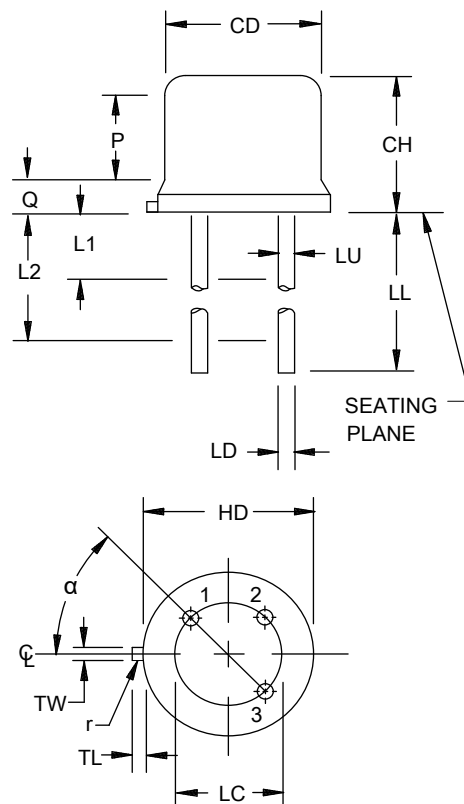

NOTES:

1. Dimension are in inches. Millimeters are given for general information only.
2. Terminal 1 = emitter, terminal 2 = base, terminal 3 = collector.
3. The collector shall be internally connected to the case.
4. Body contour optional within zone defined by dimensions CD, HD, and Q.
5. Leads at gauge plane $.054 +.001 -.000$ inch ($1.37 +0.03 -0.00$ mm) below seating plane shall be within $.007$ inch (0.18 mm) radius of true position (TP) at maximum material condition (MMC) relative to tab at MMC. The device may be measured by direct methods.
6. Dimension LU applies between dimensions L1 and L2. Dimension LD applies between dimensions L2 and LL minimum. Diameter is uncontrolled in dimension L1 and beyond dimension LL minimum.
7. All three leads.
8. For "L" suffix devices, dimension LL = 1.5 inches (38.10 mm) minimum and 1.75 inches (44.45 mm) maximum.
9. Dimension TL measured from maximum HD.
10. Beyond r (radius) maximum, dimension TW shall be held for a minimum length of $.011$ inch (0.28 mm).
11. Dimension r (radius) applies to both inside corners of tab.
12. In accordance with ASME Y14.5M, diameters are equivalent to ϕx symbology.

FIGURE 1. Physical dimensions for TO-206AA package (similar to TO-18).

MIL-PRF-19500/291Y
w/AMENDMENT 1

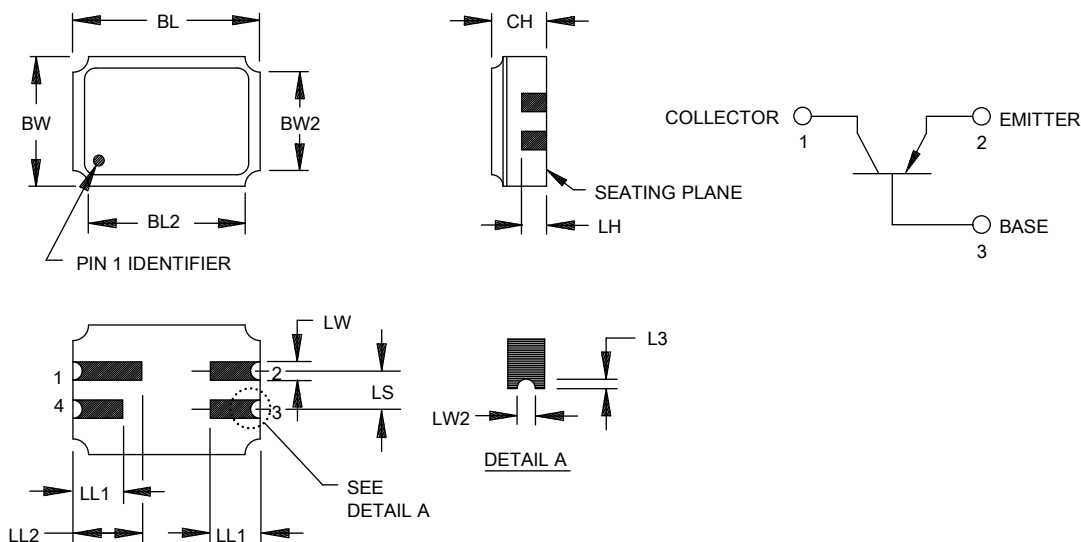

Symbol	Dimensions				Note
	Inches		Millimeters		
	Min	Max	Min	Max	
BL	.215	.225	5.46	5.71	
BL2		.225		5.71	
BW	.145	.155	3.68	3.93	
BW2		.155		3.93	
CH	.061	.075	1.55	1.90	3
L3	.003		0.08		5
LH	.029	.042	0.74	1.07	
LL1	.032	.048	0.81	1.22	
LL2	.072	.088	1.83	2.23	
LS	.045	.055	1.14	1.39	
LW	.022	.028	0.56	0.71	
LW2	.006	.022	0.15	0.56	5

NOTES:

1. Dimensions are in inches. Millimeters are given for general information only.
2. Terminal 1 = collector, terminal 2 = emitter, terminal 3 = base, terminal 4 = not connected.
3. Dimension "CH" controls the overall package thickness. When a window lid is used, dimension "CH" must increase by a minimum of .010 inch (0.254 mm) and a maximum of .040 inch (1.020 mm).
4. The corner shape (square, notch, radius) may vary at the manufacturer's option, from that shown on the drawing.
5. Dimensions "LW2" minimum and "L3" minimum and the appropriate castellation length define an unobstructed three-dimensional space traversing all of the ceramic layers in which a castellation was designed. (Castellations are required on bottom two layers, optional on top ceramic layer.) Dimension "LW2" maximum define the maximum width and depth of the castellation at any point on its surface. Measurement of these dimensions may be made prior to solder dipping.
6. The coplanarity deviation of all terminal contact points, as defined by the device seating plane, shall not exceed .006 inch (0.15 mm) for solder dipped leadless chip carriers.
7. In accordance with ASME Y14.5M, diameters are equivalent to ϕ x symbology.

FIGURE 2. Physical dimensions for 4 terminal SMD package (UA).

MIL-PRF-19500/291Y
w/AMENDMENT 1

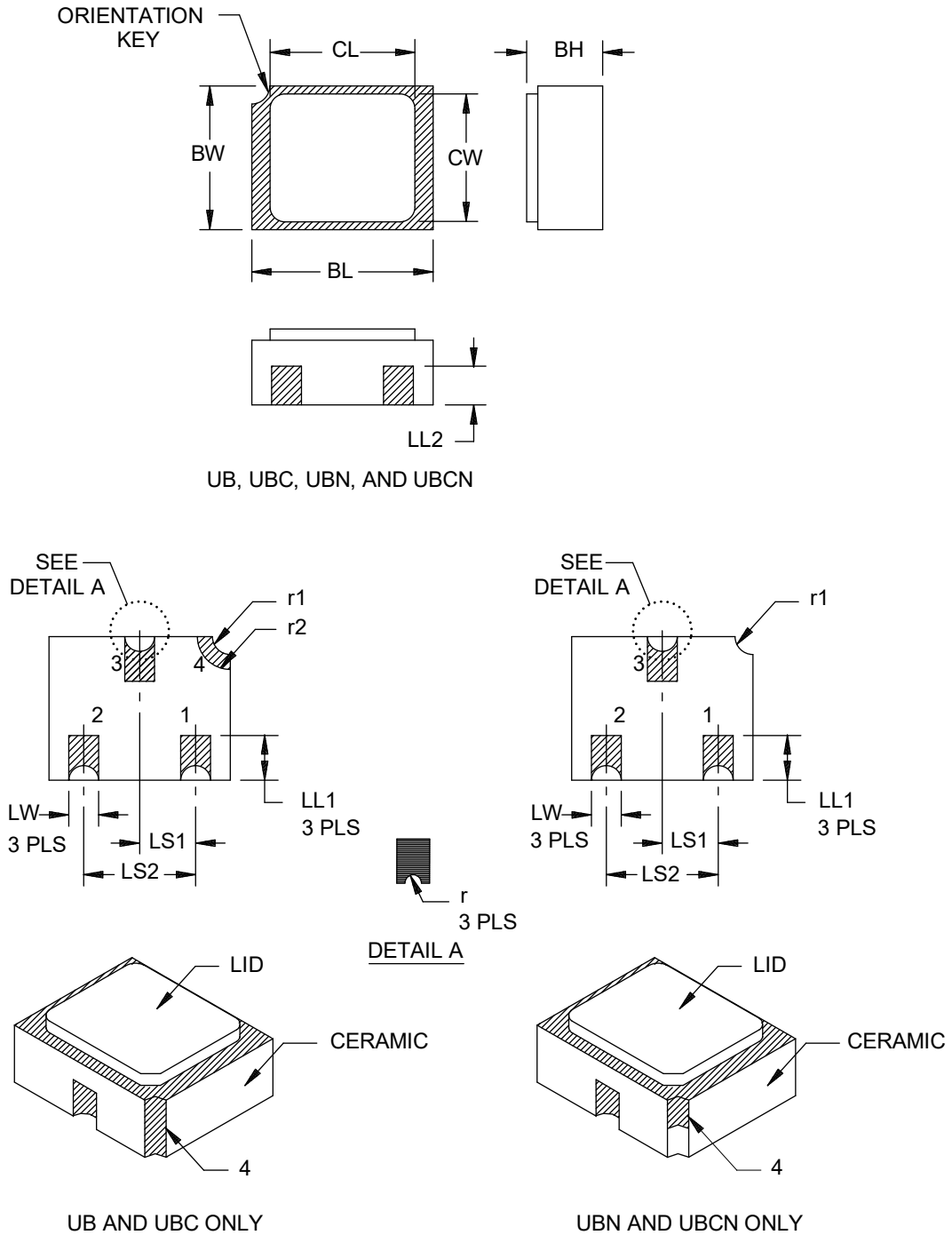

FIGURE 3. Physical dimensions for 3 and 4 terminal SMD packages (UB, UBN, UBC, and UBCN).

MIL-PRF-19500/291Y
w/AMENDMENT 1

Symbol	Dimensions				Note
	Inches		Millimeters		
	Min	Max	Min	Max	
BL	.115	.128	2.92	3.25	
BW	.085	.108	2.16	2.74	
BH	.046	.056	1.17	1.42	UB only, 3
BH	.046	.056	1.17	1.42	UBN only, 4
BH	.055	.069	1.40	1.75	UBC only, 5
BH	.055	.069	1.40	1.75	UBCN only, 6
CL		.128		3.25	
CW		.108		2.74	
LL1	.022	.038	0.56	0.97	3 PLS
LL2	.014	.035	0.356	0.89	3 PLS
LS ₁	.035	.040	0.89	1.02	
LS ₂	.071	.079	1.80	2.01	
LW	.016	.024	0.41	0.61	
r		.008		0.20	5
r1		.012		0.30	7
r2		.022		0.56	UB and UBC only, 7

NOTES:

1. Dimensions are in inches. Millimeters are given for general information only.
2. Hatched areas on package denote metallized areas.
3. UB only: Pad 1 = Base, Pad 2 = Emitter, Pad 3 = Collector, Pad 4 = Shielding connected to the metal lid.
4. UBN only: Pad 1 = Base, Pad 2 = Emitter, Pad 3 = Collector, Isolated lid with three pads only.
5. UBC (ceramic lid) only: Pad 1 = Base, Pad 2 = Emitter, Pad 3 = Collector, Pad 4 = Shielding connected to the lid.
6. UBCN (ceramic lid) only: Pad 1 = Base, Pad 2 = Emitter, Pad 3 = Collector, Isolated lid with 3 pads only.
7. For design reference only.
8. In accordance with ASME Y14.5M, diameters are equivalent to ϕx symbology.

FIGURE 3. Physical dimensions for 3 and 4 terminal SMD packages (UB, UBN, UBC, and UBCN) – Continued.

MIL-PRF-19500/291Y
w/AMENDMENT 1

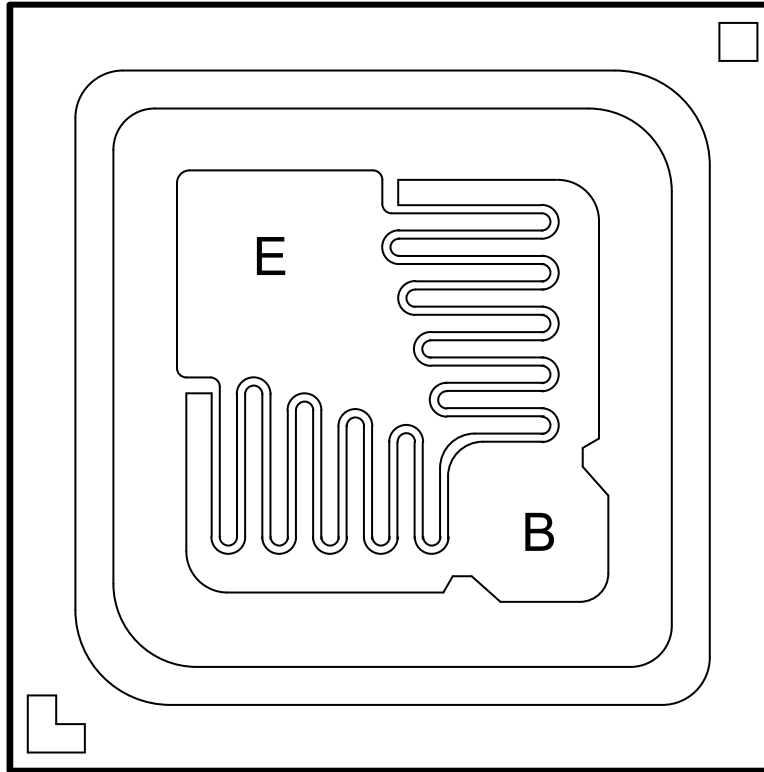

Physical characteristics (B-version):

1. Die size: .023 x .023 inch \pm .002 inch (0.584 mm x 0.584 mm \pm 0.0508 mm).
2. Die thickness: .010 \pm .0015 inch (0.254 mm \pm 0.038 mm).
3. Base pad: B = .0042 x .0042 inch (0.107 mm x 0.107 mm).
4. Emitter pad: E = .0042 x .0042 inch (0.107 mm x 0.107 mm).
5. Collector pad: Backside.
6. Top metal: Aluminum 15,000 Å minimum, 18,000 Å nominal.
7. Backside metal:
 - A. Al/Ti/Ni/Ag 15k Å/5k Å/10k Å/10k Å.
 - B. Gold 2.5 k Å minimum, 3.0 k Å nominal.
 - C. Eutectic die mount - No metal.
8. Glassivation: Si₃N₄, 2k Å minimum, 2.2k Å nominal.

FIGURE 4. JANHNC and JANKC (B-version) die dimensions.

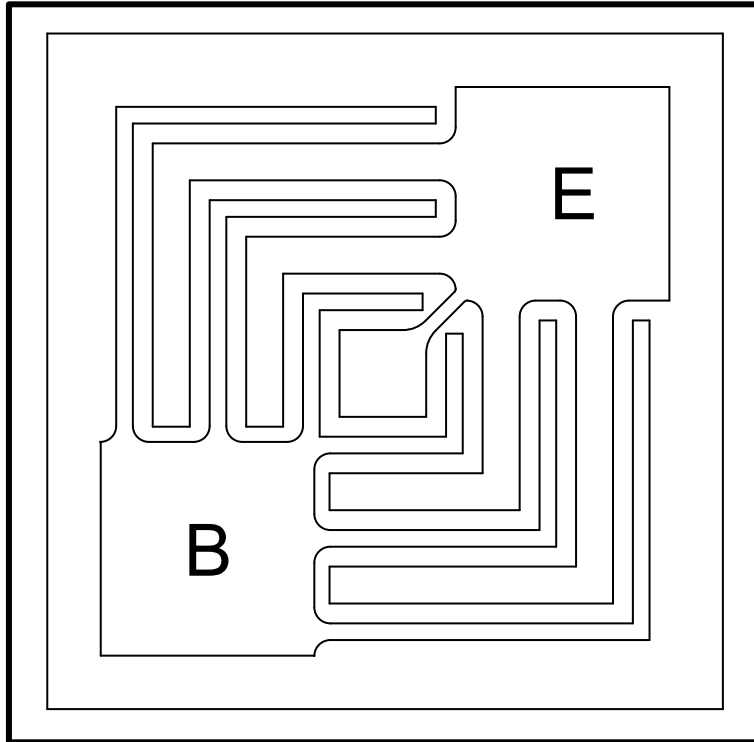

Physical characteristics (D-version):

1. Die size: .020 x .020 inch square (0.508 mm x 0.508 mm).
2. Die thickness: .008 ±.0016 inch (0.203 mm ±0.041 mm).
3. Base pad: B = .004 x .004 inch (0.101 mm x 0.101 mm).
4. Emitter pad: E = .004 x .004 inch (0.101 mm x 0.101 mm).
5. Collector: Backside.
6. Top metal: Aluminum, 20,000 ±2,000 Å.
7. Backside metal: Gold, 6,500 ±1,950 Å.
8. Glassivation: SiO₂, 7,500 ±1,500 Å.

FIGURE 5. JANHC and JANKC (D-version) die dimensions.

MIL-PRF-19500/291Y
w/AMENDMENT 1

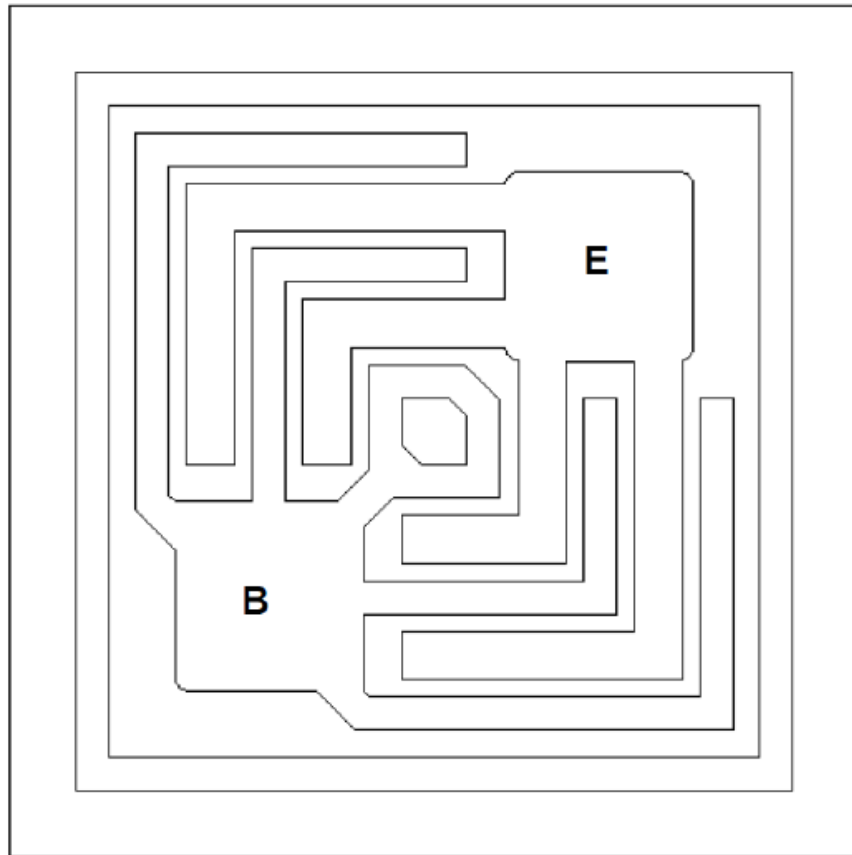

Physical characteristics (E-version):

1. Die Size: .025 x .025 Inch \pm .002 Inch (0.635 mm x 0.635 mm \pm 0.0508)
2. Die Thickness: .010 Inch \pm .002 Inch (0.254 mm \pm 0.508 mm)
3. Base pad: .004 x .004 Inch (0.109 mm x 0.109 mm)
4. Emitter pad: .004 x .004 Inch (0.109 mm x 0.109 mm)
5. Collector: Backside.
6. Top Metal: Aluminum, 16,000 Å Minimum, 24,000 Å Nominal
7. Back Metal: Gold, 4,500 Å Minimum, 5,500 Å Nominal

* FIGURE 6. JANHC and JANKC (E-version) die dimensions.

2. APPLICABLE DOCUMENTS

2.1 General. The documents listed in this section are specified in sections 3 and 4 of this specification. This section does not include documents cited in other sections of this specification or recommended for additional information or as examples. While every effort has been made to ensure the completeness of this list, document users are cautioned that they must meet all specified requirements of documents cited in sections 3 and 4 of this specification, whether or not they are listed.

2.2 Government documents.

2.2.1 Specifications, standards, and handbooks. The following specifications, standards, and handbooks form a part of this document to the extent specified herein. Unless otherwise specified, the issues of these documents are those cited in the solicitation or contract.

DEPARTMENT OF DEFENSE SPECIFICATIONS

MIL-PRF-19500 – Semiconductor Devices, General Specification for.

DEPARTMENT OF DEFENSE STANDARDS

MIL-STD-750 – Test Methods For Semiconductor Devices.

(Copies of these documents are available online at <https://quicksearch.dla.mil>.)

2.3 Order of precedence. Unless otherwise noted herein or in the contract, in the event of a conflict between the text of this document and the references cited herein, the text of this document takes precedence. Nothing in this document, however, supersedes applicable laws and regulations unless a specific exemption has been obtained.

3. REQUIREMENTS

3.1 General. The individual item requirements shall be as specified in MIL-PRF-19500 and as modified herein.

3.2 Qualification. Devices furnished under this specification shall be products that are manufactured by a manufacturer authorized by the qualifying activity for listing on the applicable qualified manufacturers list before contract award (see 4.2 and 6.3).

3.3 Abbreviations, symbols, and definitions. Abbreviations, symbols, and definitions used herein shall be as specified in MIL-PRF-19500 and as follows.

PCB	Printed circuit board
R _{θJA}	Thermal resistance junction to ambient.
R _{θJC}	Thermal resistance junction to case.
R _{θJSP(AM)}	Thermal resistance junction to solder pads (adhesive mount to PCB).
R _{θJSP(IS)}	Thermal resistance junction to solder pads (infinite sink mount to PCB).
T _{SP(AM)}	Temperature of solder pads (adhesive mount to PCB).
T _{SP(IS)}	Temperature of solder pads (infinite sink mount to PCB).
UA	Surface mount case outlines (see figure 2).
UB, UBC	Surface mount case outlines (see figure 3).
UBN, UBCN	Surface mount case outlines (see figure 3).

* 3.4 Interface and physical dimensions. The interface and physical dimensions shall be as specified in MIL-PRF-19500, and on figure 1, figure 2, figure 3, figure 4, figure 5, and figure 6 herein. Epoxy die attach may be used when a moisture monitor plan has been submitted and approved by the qualifying activity.

MIL-PRF-19500/291Y
w/AMENDMENT 1

3.4.1 Lead finish. Lead finish shall be solderable as defined in [MIL-PRF-19500](#), [MIL-STD-750](#) and herein. Where a choice of lead finish is desired, it shall be specified in the acquisition document (see [6.2](#)).

3.4.2 Pin-out. The pin-out of the encapsulated devices shall be as shown on [figures 1, 2, and 3](#) as applicable.

3.5 Marking.

3.5.1 All packaged device types except those having "UB" in the suffix. Marking shall be in accordance with [MIL-PRF-19500](#).

3.5.2 Marking of device types with "UB" in the suffix (see 1.5.4.2). Marking on the UB, UBC, UBN, and UBCN packages shall consist of an abbreviated PIN, the date code, and the manufacturer's symbol or logo. The prefixes JAN, JANTX, JANTXV, and JANS can be abbreviated as J, JX, JV, and JS respectively. The "2N" prefix and the "AUB" and "AUBC" suffix can also be omitted. The RHA designator (see [1.5.2](#)) shall immediately precede (or replace) the device "2N" identifier (depending upon degree of abbreviation required).

3.6 Electrical performance characteristics. Unless otherwise specified herein, the electrical performance characteristics are as specified in [1.3](#), [1.4](#), and [table I](#).

3.7 Electrical test requirements. The electrical test requirements shall be the subgroups specified in [table I](#) herein.

3.8 RHA. RHA requirements and test levels shall be as defined in [MIL-PRF-19500](#).

3.9 Workmanship. Transistors shall be processed in such a manner as to be uniform in quality and shall be free from other defects that will affect life, serviceability, or appearance.

4. VERIFICATION

4.1 Classification of inspections. The inspection requirements specified herein are classified as follows:

- a. Qualification inspection (see [4.2](#)).
- b. Screening (see [4.3](#)).
- c. Conformance inspection (see [4.4](#) and [tables I, II, and III](#)).
- d. Element evaluation (see [4.6](#)).

4.2 Qualification inspection. Qualification inspection shall be in accordance with [MIL-PRF-19500](#), and as specified herein.

4.2.1 JANHC and JANKC qualification. JANHC and JANKC qualification inspection shall be in accordance with [MIL-PRF-19500](#).

4.2.2 Group E qualification. Group E inspection shall be performed for qualification or re-qualification only. In case qualification was awarded to a prior revision of the specification sheet that did not request the performance of [table III](#) tests, the tests specified in [table III](#) herein that were not performed in the prior revision shall be performed on the first inspection lot of this revision to maintain qualification.

4.2.3 Radiation hardened devices. See [4.4.4](#) and [MIL-PRF-19500](#).

MIL-PRF-19500/291Y
w/AMENDMENT 1

4.3 Screening of encapsulated devices (quality levels JANTX, JANTXV, and JANS only). Screening shall be in accordance with table E-IV of MIL-PRF-19500, and as specified herein. The following measurements shall be made in accordance with table I herein. Devices that exceed the limits of table I herein shall not be acceptable.

Screen	Measurement	
	JANS level	JANTXV and JANTX level
1b	Required	Required (JANTXV only)
2	Optional	Optional
3a	Required	Required
3b	Not applicable	Not applicable
(1) 3c	Required (see 4.3.2)	Required (see 4.3.2)
4	Required	Optional
5	Required	Not required
6	Not applicable	Not applicable
8	Required	Not required
9	I _{CB02} , h _{FE4} , read and record	Not applicable
10	24 hours minimum	24 hours minimum
11	I _{CB02} ; h _{FE4} ; ΔI _{CB02} = 100 percent of initial value or 5 nA dc, whichever is greater. Δh _{FE4} = ±15 percent	I _{CB02} , h _{FE4}
12	See 4.3.1	See 4.3.1
(2) 13	Subgroups 2 and 3 of table I herein; ΔI _{CB02} = 100 percent of initial value or 5 nA dc, whichever is greater; Δh _{FE4} = ±15 percent	Subgroup 2 of table I herein; ΔI _{CB02} = 100 percent of initial value or 5 nA dc, whichever is greater; Δh _{FE4} = ±15 percent
15	Required	Not required
16	Required	Not required

- (1) Shall be performed anytime after temperature cycling, screen 3a; TX and TXV do not need to be repeated in screening requirements.
- (2) Thermal impedance (Z_{θJX}) is not required in screen 13.

4.3.1 Power burn-in conditions. Power burn-in conditions shall be as follows: V_{CB} = -10 to -30 V dc. Power shall be applied to achieve T_J = +135°C minimum using a minimum P_D = 75 percent of P_T maximum, T_A ambient rated as defined in 1.3. With approval of the qualifying activity and preparing activity, alternate burn-in criteria (hours, bias conditions, T_J, and mounting conditions) for JANTX and JANTXV quality levels may be used. A justification demonstrating equivalence is required. In addition, the manufacturing site's burn-in data and performance history will be essential criteria for burn-in modification approval.

MIL-PRF-19500/291Y
w/AMENDMENT 1

* 4.3.2 Thermal impedance measurements. The thermal impedance measurements shall be performed in accordance with method 3131 of MIL-STD-750 using the guidelines in that method for determining I_M , I_H , t_H , and t_{MD} (and V_C where appropriate). The thermal impedance limit used in screen 3c of 4.3 herein and subgroup 2 of table I shall comply with the thermal impedance graphs in figure 12, figure 13, figure 14, figure 15, and figure 16 (less than or equal to the curve value at the same t_H time) and shall be less than the process determined statistical maximum limit as outlined in method 3131. See table III, subgroup 4 herein.

4.4 Conformance inspection. Conformance inspection shall be in accordance with MIL-PRF-19500, and as specified herein. If alternate screening is being performed in accordance with MIL-PRF-19500, a sample of screened devices shall be submitted to and pass the requirements of subgroups 1 and 2, of table I herein, inspection only (table E-VIB, group B, subgroup 1 is not required to be performed again if group B has already been satisfied in accordance with 4.4.2).

4.4.1 Group A inspection. Group A inspection shall be conducted in accordance with MIL-PRF-19500 and table I herein.

4.4.2 Group B inspection. Group B inspection shall be conducted in accordance with 4.4.2.1 for quality level JANS and 4.4.2.2 for quality levels JAN, JANTX, and JANTXV.

4.4.2.1 Quality level JANS. Group B inspection for quality level JANS shall be conducted in accordance with the conditions specified for subgroup testing in table E-VIA of MIL-PRF-19500 and herein. Delta measurements shall be in accordance with 4.7 herein.

<u>Subgroup</u>	<u>Method</u>	<u>Condition</u>
B4	1037	$V_{CB} = -10$ to -30 V dc. Adjust device current, or power, to achieve a minimum ΔT_J of 100°C .
B5	1027	$V_{CB} = -10$ V dc; $P_D \geq 100$ percent of maximum rated P_T (see 1.3). (NOTE: If a failure occurs, resubmission shall be at the test conditions of the original sample.) Option 1: 96 hours minimum sample size in accordance with MIL-PRF-19500, table E-VIA, adjust T_A or P_D to achieve $T_J = +275^\circ\text{C}$ minimum. Option 2: 216 hours minimum, sample size = 45, $c = 0$; adjusted T_A or P_D to achieve a $T_J = +225^\circ\text{C}$ minimum.
B6	3131	$R_{\theta JA}$, $R_{\theta JC}$ only (see 1.3).

MIL-PRF-19500/291Y
w/AMENDMENT 1

4.4.2.2 Quality levels JAN, JANTX, and JANTXV. Group B inspection for quality levels JAN, JANTX, and JANTXV shall be conducted in accordance with the conditions specified in table E-VIC (small die flow) of MIL-PRF-19500 and herein. Delta measurements shall be taken after each step and shall be in accordance with 4.7 herein. All catastrophic failures during CI shall be analyzed to the extent possible to identify root cause and corrective action. Whenever a failure is identified as wafer lot or wafer processing related, the entire wafer lot and related devices assembled from the wafer lot shall be rejected unless an appropriate determined corrective action to eliminate the failure mode has been implemented and the devices from the wafer lot are screened to eliminate the failure mode.

<u>Step</u>	<u>Method</u>	<u>Condition</u>
1	1026	Steady-state life: 1,000 hours minimum, $V_{CB} = -10$ dc, power and ambient shall be applied to achieve $T_J = +150^\circ\text{C}$ minimum using a minimum of $P_D = 75$ percent of maximum rated P_T as defined in 1.3. $n = 45$ devices, $c = 0$. The sample size may be increased and the test time decreased so long as the devices are stressed for a total of 45,000 device hours minimum, and the actual time of test is at least 340 hours.
2	1048	Blocking life, $T_A = +150^\circ\text{C}$, $V_{CB} = 80$ percent of rated voltage, 48 hours minimum. $n = 45$ devices, $c = 0$.
3	1032	High-temperature life (non-operating), $t = 340$ hours, $T_A = +200^\circ\text{C}$. $n = 22$, $c = 0$.

4.4.2.2.1 Sample selection. Samples selected for small die flow group B inspection shall be in accordance with all of the following requirements:

- Samples shall be selected from an inspection lot that has been submitted to and passed table I, subgroup 2, conformance inspection.
- When the final lead finish is solder or any plating prone to oxidation at high temperature, the samples for life test (step 1) may be tested prior to the application of final lead finish.
- Separate samples may be used for each step.

4.4.3 Group C inspection. Group C inspection shall be conducted in accordance with the conditions specified for subgroup testing in table E-VII of MIL-PRF-19500, and in 4.4.3.1 for quality level JANS and 4.4.3.2 for quality levels JAN, JANTX, and JANTXV. Delta measurements shall be in accordance with table I, subgroup 2 and 4.7 herein.

4.4.3.1 Quality level JANS.

<u>Subgroup</u>	<u>Method</u>	<u>Condition</u>
C2	2036	Test condition E, (not applicable for UA, UB, UBC, UBN, and UBCN devices).
C6	1026	1,000 hours, $V_{CB} = -10$ V dc, power and ambient temperature shall be applied to the device to achieve $T_J = +150^\circ\text{C}$ minimum, and minimum power dissipation of 75 percent of max rated P_T (see 1.3 herein); $n = 45$, $c = 0$. The sample size may be increased and the test time decreased as long as the devices are stressed for a total of 45,000 device hours minimum, and the actual time of test is at least 340 hours.

4.4.3.2 Quality levels JAN, JANTX, and JANTXV.

<u>Subgroup</u>	<u>Method</u>	<u>Condition</u>
C2	2036	Test condition E, (not applicable for UA, UB, UBC, UBN, and UBCN devices).
C5	3131	R _{θJA} R _{θJC} only (see 1.3).
C6		Not applicable.

4.4.3.3 Sample selection. Samples for subgroups in group C shall be chosen at random from any inspection lot containing the intended package type and lead finish procured to the same specification which is submitted to and passes [table I](#) tests herein for conformance inspection. When the final lead finish is solder or any plating prone to oxidation at high temperature, the samples for C6 life test may be tested prior to the application of final lead finish. Testing of a subgroup using a single device type enclosed in the intended package type shall be considered as complying with the requirements for that subgroup.

4.4.4 Group D inspection. Conformance inspection for radiation hardness assured JANS and JANTXV types shall include the group D tests specified in [table II](#) herein. These tests shall be performed as required in accordance with [MIL-PRF-19500](#) and method 1019 of [MIL-STD-750](#), for total ionizing dose or method 1017 of [MIL-STD-750](#) for neutron fluence as applicable (see [6.2](#) herein), except group D, subgroup 2 may be performed separate from other subgroups. Alternate package options may also be substituted for the testing provided there is no adverse effect to the fluence profile.

4.4.5 Group E inspection. Group E inspection shall be conducted in accordance with the conditions specified for subgroup testing in table E-IX of [MIL-PRF-19500](#) and as specified in [table III](#) herein. Delta measurements shall be in accordance with the applicable steps of [4.7](#).

4.5 Method of inspection. Methods of inspection shall be as specified in the appropriate tables and as follows.

4.5.1 Pulse measurements. Conditions for pulse measurement shall be as specified in section 4 of [MIL-STD-750](#).

4.5.2 Input capacitance. This test shall be conducted in accordance with method 3240 of [MIL-STD-750](#), except the output capacitor shall be omitted.

4.5.3 Displacement damage characterization. For RHA devices, each supplier shall perform a displacement damage characterization. The characterization shall demonstrate exposure versus data and does not indicate pass or fail criteria. The exposure shall be conducted in accordance with method 1017 of [MIL-STD-750](#). The following details shall apply:

- a. Samples may be taken from any wafer of the qualification lot.
- b. As a minimum, testing shall be at $2E+12$ n/cm² plus two additional neutron fluence levels chosen by the supplier.
- c. If the device degrades less than 5 percent of the specification at the highest neutron fluence level, a single data point may be sufficient.

Alternate package options may be substituted for characterization. The displacement damage characterization data shall be made available from the supplier.

4.6 Element evaluation of unencapsulated die. The element evaluation of unencapsulated die shall be in accordance with appendix G of [MIL-PRF-19500](#). For subgroup 4, the burn-in duration for the JANKC level shall follow the JANS requirements and the JANHC shall follow the JANTX requirements.

MIL-PRF-19500/291Y
w/AMENDMENT 1

4.7 Delta measurements. Delta measurements shall be as specified below:

Step	Inspection	MIL-STD-750		Symbol	Limit
		Method	Conditions		
1	Collector-base cutoff current	3036	Bias condition D, $V_{CB} = -50$ V dc	ΔI_{CB02} (1)	100 percent of initial value or 10 nA dc, whichever is greater.
2	Forward current transfer ratio	3076	$V_{CE} = -10$ V dc; $I_C = -150$ mA dc; pulsed see 4.5.1	Δh_{FE4} (1)	± 25 percent change from initial reading.

(1) Devices which exceed the [table I](#) limits for this test shall not be accepted.

TABLE I. Group A inspection.

Inspection 1/	MIL-STD-750		Symbol	Limit		Unit
	Method	Conditions		Min	Max	
<u>Subgroup 1</u> 2/						
Visual and mechanical inspection 3/	2071					
Solderability 3/ 4/	2026	$n = 15$ leads, $c = 0$				
Resistance to solvents 3/ 4/ 5/	1022	$n = 15$ devices, $c = 0$				
* Salt atmosphere 4/ 6/	1041	$n = 6$ devices, $c = 0$				
Temperature cycling 3/ 4/ (air to air)	1051	Test condition C, 25 cycles $n = 22$ devices, $c = 0$				
Hermetic seal 4/ Fine leak Gross leak	1071	$n = 22$ devices, $c = 0$				
Electrical measurements 4/		Table I , subgroup 2				
Bond strength 3/ 4/	2037	Precondition $T_A = +250^\circ\text{C}$ at $t = 24$ hours or $T_A = +300^\circ\text{C}$ at $t = 2$ hours $n = 11$ wires, $c = 0$				
Decap internal visual (design verification) 4/	2075	$n = 4$ devices, $c = 0$				

See footnotes at end of table.

MIL-PRF-19500/291Y
w/AMENDMENT 1

TABLE I. Group A inspection - Continued.

Inspection <u>1/</u>	MIL-STD-750		Symbol	Limit		Unit
	Method	Conditions		Min	Max	
<u>Subgroup 2</u>						
Thermal impedance <u>7/</u>	3131	See <u>4.3.2</u>	$Z_{\theta JX}$			°C/W
Collector to base cutoff current	3036	Bias condition D; $V_{CB} = -60$ V dc	I_{CBO1}		-10	μA dc
Cutoff current, emitter to base	3061	Bias condition D; $V_{EB} = -5$ V dc	I_{EBO1}		-10	μA dc
Breakdown voltage, collector to emitter	3011	Bias condition D; $I_C = -10$ mA dc; pulsed (see <u>4.5.1</u>)	$V_{(BR)CEO}$	-60		V dc
Collector to emitter cutoff current	3041	Bias condition C; $V_{CE} = -50$ V dc	I_{CES}		-50	nA dc
Collector to base cutoff current	3036	Bias condition D; $V_{CB} = -50$ V dc	I_{CBO2}		-10	nA dc
Emitter to base cutoff current	3061	Bias condition D; $V_{EB} = -4$ V dc	I_{EBO2}		-50	nA dc
Forward-current transfer ratio 2N2906A <u>8/</u> 2N2907A <u>8/</u>	3076	$V_{CE} = -10$ V dc; $I_C = -0.1$ mA dc	h_{FE1}	40 75		
Forward-current transfer ratio 2N2906A <u>8/</u> 2N2907A <u>8/</u>	3076	$V_{CE} = -10$ V dc; $I_C = -1.0$ mA dc	h_{FE2}	40 100	175 450	
Forward-current transfer ratio 2N2906A <u>8/</u> 2N2907A <u>8/</u>	3076	$V_{CE} = -10$ V dc; $I_C = -10$ mA dc	h_{FE3}	40 100		
Forward-current transfer ratio 2N2906A <u>8/</u> 2N2907A <u>8/</u>	3076	$V_{CE} = -10$ V dc; $I_C = -150$ mA dc; pulsed (see <u>4.5.1</u>)	h_{FE4}	40 100	120 300	

See footnotes at end of table.

MIL-PRF-19500/291Y
w/AMENDMENT 1

TABLE I. Group A inspection - Continued.

Inspection <u>1/</u>	MIL-STD-750		Symbol	Limit		Unit
	Method	Conditions		Min	Max	
<u>Subgroup 2</u> - continued.						
Forward-current transfer ratio 2N2906A <u>8/</u> 2N2907A <u>8/</u>	3076	$V_{CE} = -10$ V dc; $I_C = -500$ mA dc; pulsed (see <u>4.5.1</u>)	h_{FE5}	40 50		
Collector-emitter saturation voltage	3071	$I_C = -150$ mA dc; $I_B = -15$ mA dc, pulsed (see <u>4.5.1</u>)	$V_{CE(sat)1}$		-0.4	V dc
Collector-emitter saturation voltage	3071	$I_C = -500$ mA dc; $I_B = -50$ mA dc; pulsed (see <u>4.5.1</u>)	$V_{CE(sat)2}$		-1.6	V dc
Base-emitter saturation voltage	3066	Test condition A; $I_C = -150$ mA dc; $I_B = -15$ mA dc; pulsed (see <u>4.5.1</u>)	$V_{BE(sat)1}$	-0.6	-1.3	V dc
Base-emitter saturation voltage	3066	Test condition A; $I_C = -500$ mA dc; $I_B = -50$ mA dc; pulsed (see <u>4.5.1</u>)	$V_{BE(sat)2}$		-2.6	V dc
<u>Subgroup 3</u>						
High temperature operation		$T_A = +150^\circ\text{C}$				
Collector to base cutoff current	3036	Bias condition D; $V_{CB} = -50$ V dc	I_{CB03}		-10	μA dc
Low temperature operation		$T_A = -55^\circ\text{C}$				
Forward-current transfer ratio 2N2906A <u>8/</u> 2N2907A <u>8/</u>	3076	$V_{CE} = -10$ V dc; $I_C = -10$ mA dc	h_{FE6}	20 50		
<u>Subgroup 4</u>						
Small-signal short-circuit forward current transfer ratio 2N2906A <u>8/</u> 2N2907A <u>8/</u>	3206	$V_{CE} = -10$ V dc; $I_C = -1$ mA dc; $f = 1$ kHz	h_{fe}	40 100		

See footnotes at end of table.

MIL-PRF-19500/291Y
w/AMENDMENT 1

TABLE I. Group A inspection - Continued.

Inspection <u>1/</u>	MIL-STD-750		Symbol	Limit		Unit
	Method	Conditions		Min	Max	
<u>Subgroup 4</u> - continued.						
Forward-current transfer ratio	3076	$V_{CE} = -10$ V dc; $I_C = -500$ mA dc; pulsed (see 4.5.1)	h_{FE5}			
Magnitude of small-signal short-circuit forward current transfer ratio	3306	$V_{CE} = -20$ V dc; $I_C = -20$ mA dc; $f = 100$ MHz	$ h_{fe} $	2.0		
Open circuit output capacitance	3236	$V_{CB} = -10$ V dc; $I_E = 0$; 100 kHz $\leq f \leq 1$ MHz	C_{obo}		8	pF
Input capacitance (output open-circuited)	3240	$V_{EB} = -2.0$ V dc; $I_C = 0$; 100 kHz $\leq f \leq 1$ MHz; see 4.5.2.	C_{ibo}		30	pF
Saturated turn-on time		(See figure 17)	t_{on}		45	ns
Saturated turn-off time		(See figure 18)	t_{off}		300	ns
<u>Subgroups 5, 6, and 7</u>						
Not applicable						

1/ For sampling plan see MIL-PRF-19500.

2/ For resubmission of failed test subgroup of table I, double the sample size of the failed test or sequence of tests. A failure in table I, subgroup 1 shall not require retest of the entire subgroup. Only the failed test shall be rerun upon submission.

3/ Separate samples may be used.

4/ Not required for JANS devices.

5/ Not required for laser marked devices.

6/ Required only for laser marked devices. Not required for non-corrosion prone base metals.

7/ For end-point measurements, this test is required for the following subgroups:

Group B, subgroup 3, 4, and 5 (JANS).

Group B, step 1 (TX and TXV).

Group C, subgroup 2 and 6.

8/ Includes device types with package designators "L", "UA", "UB", "UBC", "UBN", and "UBCN".

MIL-PRF-19500/291Y
w/AMENDMENT 1

TABLE II. Group D inspection.

Inspection 1/ 2/ 3/	MIL-STD-750		Symbol	Limit		Unit
	Method	Conditions		Min	Max	
<u>Subgroup 1</u> 4/						
Neutron irradiation	1017	Neutron exposure $V_{CES} = 0$ V				
Collector to base cutoff current	3036	Bias condition D; $V_{CB} = -60$ V dc	ICBO1		-20	μ A dc
Cutoff current, emitter to base	3061	Bias condition D; $V_{EB} = -5$ V dc	IEBO1		-20	μ A dc
Breakdown voltage, collector to emitter	3011	Bias condition D; $I_C = -10$ mA dc; pulsed (see 4.5.1)	$V_{(BR)CEO}$	-60		V dc
Collector to emitter cutoff current	3041	Bias condition C; $V_{CE} = -50$ V dc	ICES		-100	nA dc
Collector to base cutoff current	3036	Bias condition D; $V_{CB} = -50$ V dc	ICBO2		-20	nA dc
Emitter to base cutoff current	3061	Bias condition D; $V_{EB} = -4$ V dc	IEBO2		-100	nA dc
Forward-current transfer ratio M through H2N2906A M through H2N2907A	3076	$V_{CE} = -10$ V dc; $I_C = -0.1$ mA dc	$[h_{FE1}]$ 5/	[20] [37.5]		
Forward-current transfer ratio M through H2N2906A M through H2N2907A	3076	$V_{CE} = -10$ V dc; $I_C = -1.0$ mA dc	$[h_{FE2}]$ 5/	[20] [50]	175 450	
Forward-current transfer ratio M through H2N2906A M through H2N2907A	3076	$V_{CE} = -10$ V dc; $I_C = -10$ mA dc	$[h_{FE3}]$ 5/	[20] [50]		
Forward-current transfer ratio M through H2N2906A M through H2N2907A	3076	$V_{CE} = -10$ V dc; $I_C = -150$ mA dc	$[h_{FE4}]$ 5/	[20] [50]	120 300	
Forward-current transfer ratio M through H2N2906A M through H2N2907A	3076	$V_{CE} = -10$ V dc; $I_C = -500$ mA dc	$[h_{FE5}]$ 5/	[20] [25]		
Collector-emitter saturation voltage	3071	$I_C = -150$ mA dc; $I_B = -15$ mA dc	$V_{CE(sat)1}$		-0.46	V dc
Collector-emitter saturation voltage	3071	$I_C = -500$ mA dc; $I_B = -50$ mA dc	$V_{CE(sat)2}$		-1.84	V dc
Base-emitter saturation voltage	3066	Test condition A; $I_C = -150$ mA dc; $I_B = -15$ mA dc; pulsed (see 4.5.1)	$V_{BE(sat)1}$	-0.6	-1.5	V dc
Base-emitter saturation voltage	3066	Test condition A; $I_C = -500$ mA dc; $I_B = -50$ mA dc; pulsed (see 4.5.1)	$V_{BE(sat)2}$		-3.0	

See footnotes at end of table.

MIL-PRF-19500/291Y
w/AMENDMENT 1

TABLE II. Group D inspection - Continued.

Inspection <u>1/</u> <u>2/</u> <u>3/</u>	MIL-STD-750		Symbol	Limit		Unit
	Method	Conditions		Min	Max	
<u>Subgroup 2</u>						
Total dose irradiation	1019	Gamma exposure $V_{CES} = -48$ V				
Collector to base cutoff current	3036	Bias condition D; $V_{CB} = -60$ V dc	ICBO1		-20	μ A dc
Cutoff current, emitter to base	3061	Bias condition D; $V_{EB} = -5$ V dc	IEBO1		-20	μ A dc
Breakdown voltage, collector to emitter	3011	Bias condition D; $I_C = -10$ mA dc; pulsed (see 4.5.1)	$V_{(BR)CEO}$	-60		V dc
Collector to emitter cutoff current	3041	Bias condition C; $V_{CE} = -50$ V dc	ICES		-100	nA dc
Collector to base cutoff current	3036	Bias condition D; $V_{CB} = -50$ V dc	ICBO2		-20	nA dc
Emitter to base cutoff current	3061	Bias condition D; $V_{EB} = -4$ V dc	IEBO2		-100	nA dc
Forward-current transfer ratio M through H2N2906A M through H2N2907A	3076	$V_{CE} = -10$ V dc; $I_C = -0.1$ mA dc	$[h_{FE1}]$ <u>5/</u>	[20] [37.5]		
Forward-current transfer ratio M through H2N2906A M through H2N2907A	3076	$V_{CE} = -10$ V dc; $I_C = -1.0$ mA dc	$[h_{FE2}]$ <u>5/</u>	[20] [50]	175 400	
Forward-current transfer ratio M through H2N2906A M through H2N2907A	3076	$V_{CE} = -10$ V dc; $I_C = -10$ mA dc	$[h_{FE3}]$ <u>5/</u>	[20] [50]		
Forward-current transfer ratio M through H2N2906A M through H2N2907A	3076	$V_{CE} = -10$ V dc; $I_C = -150$ mA dc	$[h_{FE4}]$ <u>5/</u>	[20] [50]	120 300	
Forward-current transfer ratio M through H2N2906A M through H2N2907A	3076	$V_{CE} = -10$ V dc; $I_C = -500$ mA dc	$[h_{FE5}]$ <u>5/</u>	[20] [25]		
Collector-emitter saturation voltage	3071	$I_C = -150$ mA dc; $I_B = -15$ mA dc;	$V_{CE(sat)1}$		-4.6	V dc
Collector-emitter saturation voltage	3071	$I_C = -500$ mA dc; $I_B = -50$ mA dc;	$V_{CE(sat)2}$		-1.84	V dc
Base-emitter saturation voltage	3066	Test condition A; $I_C = -150$ mA dc; $I_B = -15$ mA dc; pulsed (see 4.5.1)	$V_{BE(sat)1}$	-0.6	-1.5	V dc
Base-emitter saturation voltage	3066	Test condition A; $I_C = -500$ mA dc; $I_B = -50$ mA dc; pulsed (see 4.5.1)	$V_{BE(sat)2}$		-3.0	V dc

1/ Tests to be performed on all devices receiving radiation exposure.

2/ For sampling plan, see MIL-PRF-19500.

3/ Electrical characteristics apply to the corresponding L, UA, UB, UBC, UBN, and UBCN suffix versions unless otherwise noted.

4/ See 6.2.f herein.

5/ See method 1019, of MIL-STD-750, for how to determine $[h_{FE}]$ by first calculating the delta ($1/h_{FE}$) from the pre-and post-radiation h_{FE} . Notice the $[h_{FE}]$ is not the same as h_{FE} and cannot be measured directly. The $[h_{FE}]$ value can never exceed the pre-radiation minimum h_{FE} that it is based upon.

MIL-PRF-19500/291Y
w/AMENDMENT 1

TABLE III. Group E inspection (all quality levels) - for qualification only.

Inspection	MIL-STD-750		Sample plan
	Method	Conditions	
<u>Subgroup 1</u>			45 devices c = 0
Temperature cycling (air to air)	1051	Test condition C, 500 cycles.	
Hermetic seal Fine leak Gross leak	1071		
Electrical measurements		See table I , subgroup 2 and 4.7 herein.	
<u>Subgroup 2</u>			45 devices c = 0
Intermittent life	1037	$V_{CB} = -10$ V dc, 6,000 cycles. Adjust device current, or power, to achieve a minimum ΔT_J of 100°C.	
Electrical measurements		See table I , subgroup 2 and 4.7 herein.	
<u>Subgroup 4</u>			15 devices c = 0
Thermal resistance	3131	$R_{\theta_{JSP(IS)}}$ may be calculated but shall be measured once in the same package with a similar die size to confirm calculations (may apply to multiple slash sheets). $R_{\theta_{JSP(AM)}}$ need be calculated only.	
Thermal impedance curves		See MIL-PRF-19500 , table E-IX, subgroup 4.	Sample size N/A
<u>Subgroup 5</u>			
Not applicable			
<u>Subgroup 6</u>			
ESD	1020		
<u>Subgroup 8</u>			45 devices c = 0
Reverse stability	1033	Condition B.	
<u>Subgroup 12</u>			
Neutron irradiation	1017	See 4.5.3 .	

MIL-PRF-19500/291Y
w/AMENDMENT 1

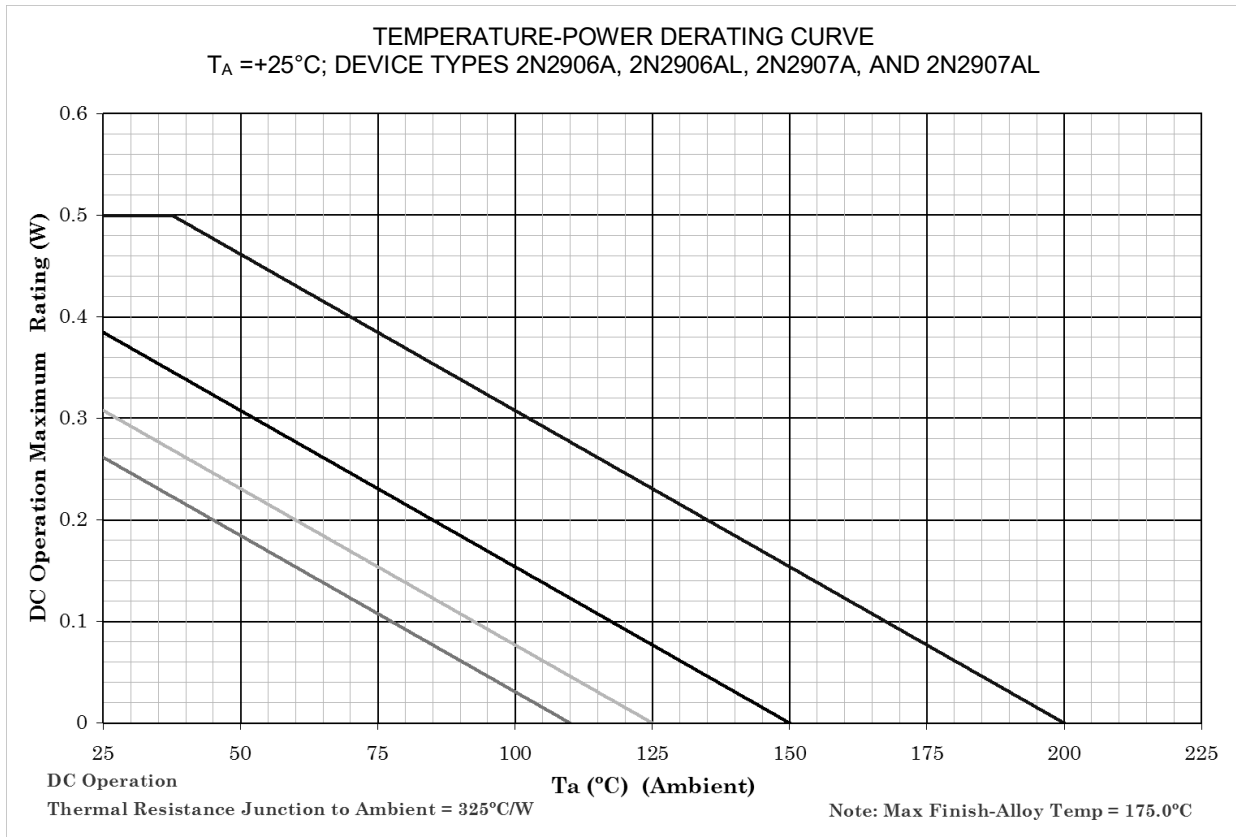

NOTES:

1. This is the true inverse of the worst case thermal resistance value. All devices are capable of operating at $\leq T_J$ specified on this curve. Any parallel line to this curve will intersect the appropriate power for the desired maximum T_J allowed.
2. Derate design curve constrained by the maximum junction temperatures and power rating specified. (See 1.3 herein.)
3. Derate design curve chosen at $T_J \leq +150^\circ\text{C}$, where the maximum temperature of electrical test is performed.
4. Derate design curve chosen at $T_J \leq +125^\circ\text{C}$, and $+110^\circ\text{C}$ to show power rating where most users want to limit T_J in their application.

* FIGURE 7. Temperature-power derating for TO-206AA package ($R_{\theta JA}$) leads .125 inch (3.18 mm) PCB.

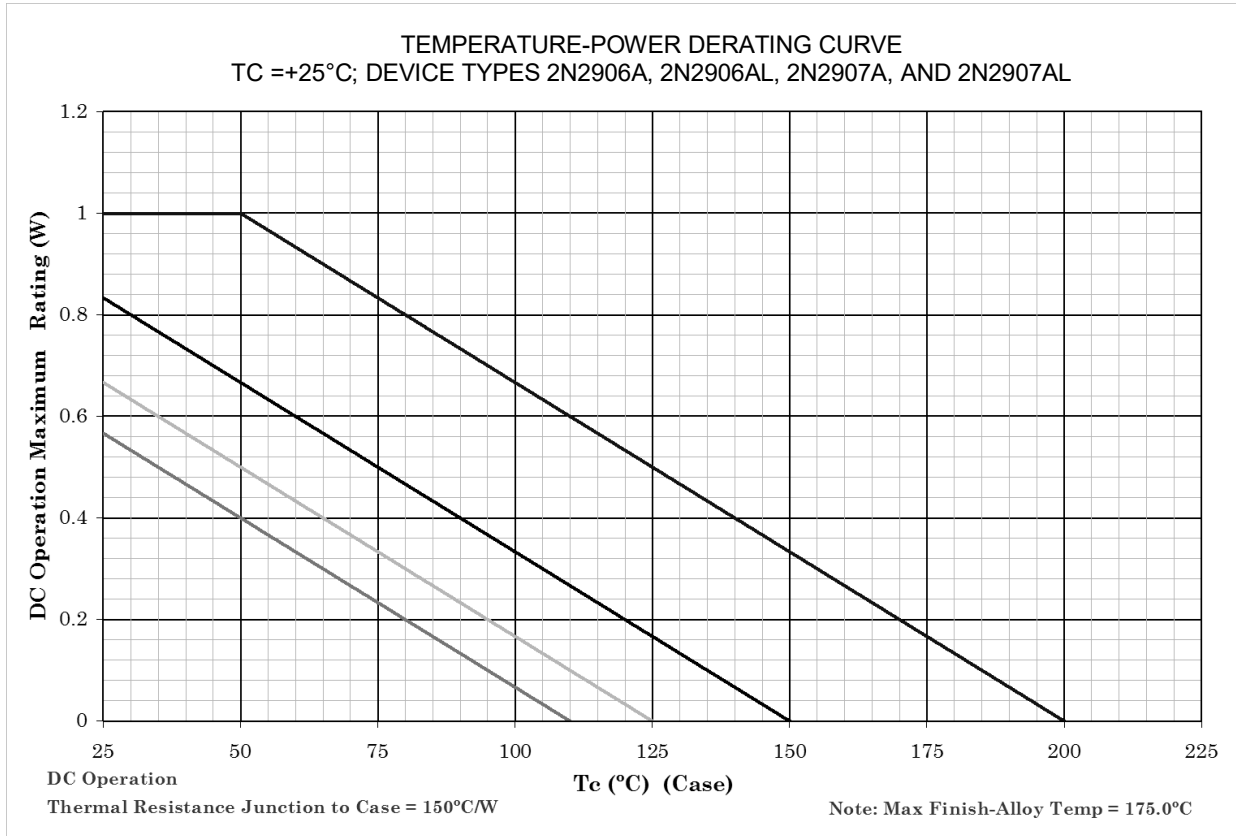

NOTES:

1. This is the true inverse of the worst case thermal resistance value. All devices are capable of operating at $\leq T_J$ specified on this curve. Any parallel line to this curve will intersect the appropriate power for the desired maximum T_J allowed.
2. Derate design curve constrained by the maximum junction temperatures and power rating specified. (See 1.3 herein.)
3. Derate design curve chosen at $T_J \leq +150^\circ\text{C}$, where the maximum temperature of electrical test is performed.
4. Derate design curve chosen at $T_J \leq +125^\circ\text{C}$, and $+110^\circ\text{C}$ to show power rating where most users want to limit T_J in their application.

* FIGURE 8. Temperature-power derating for TO-206AA package ($R_{\theta JC}$), base case mount.

MIL-PRF-19500/291Y
w/AMENDMENT 1

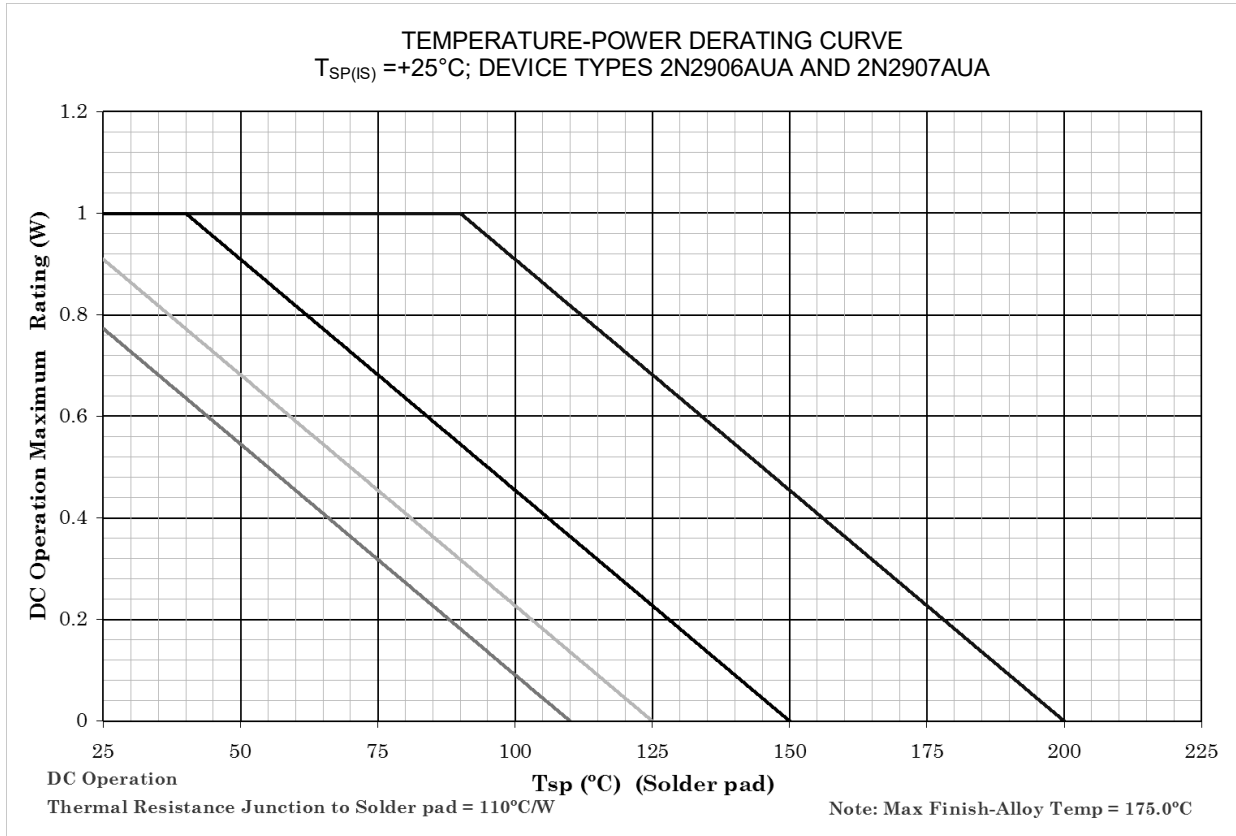

NOTES:

1. This is the true inverse of the worst case thermal resistance value. All devices are capable of operating at $\leq T_J$ specified on this curve. Any parallel line to this curve will intersect the appropriate power for the desired maximum T_J allowed.
2. Derate design curve constrained by the maximum junction temperatures and power rating specified. (See 1.3 herein.)
3. Derate design curve chosen at $T_J \leq +150^{\circ}\text{C}$, where the maximum temperature of electrical test is performed.
4. Derate design curve chosen at $T_J \leq +125^{\circ}\text{C}$, and $+110^{\circ}\text{C}$ to show power rating where most users want to limit T_J in their application.

* FIGURE 9. Temperature-power derating for UA package ($R_{\theta JSP(IS)}$), infinite sink 4-points.

MIL-PRF-19500/291Y
w/AMENDMENT 1

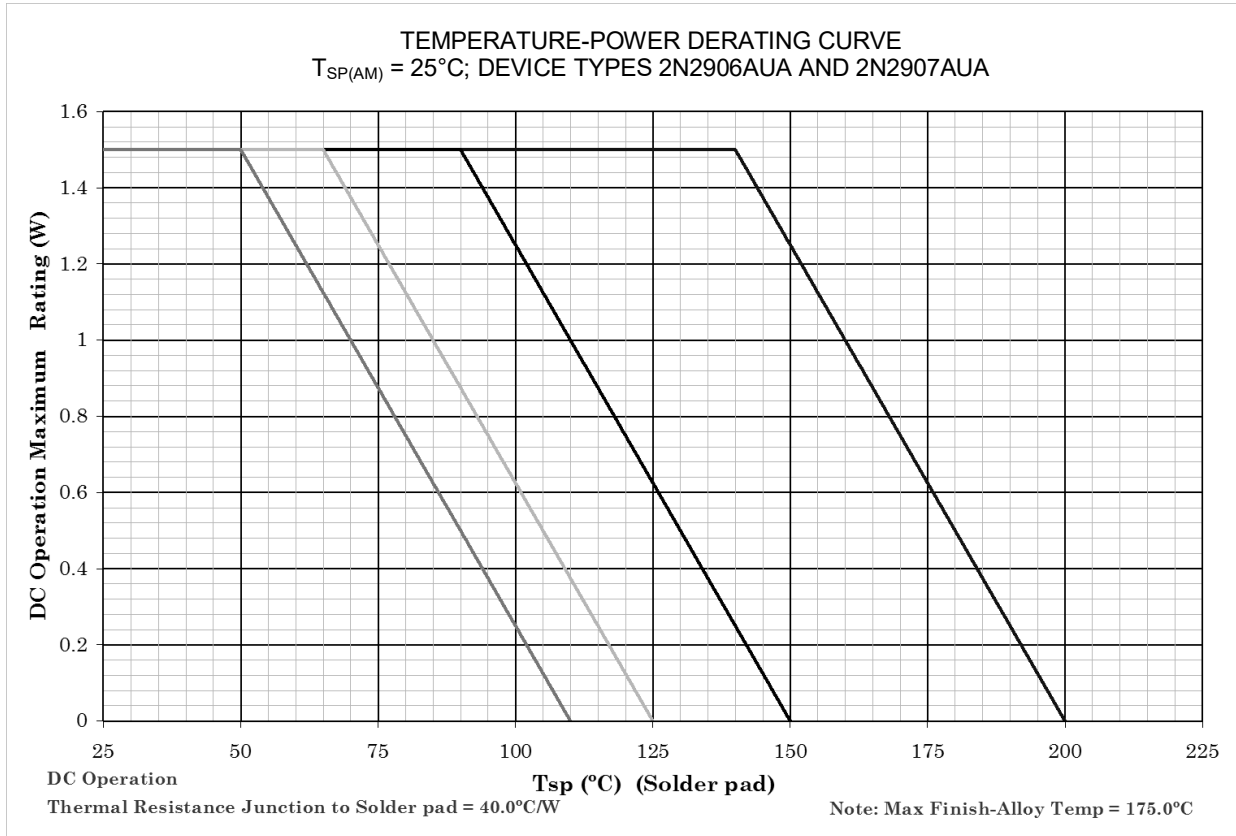

NOTES:

1. This is the true inverse of the worst case thermal resistance value. All devices are capable of operating at $\leq T_J$ specified on this curve. Any parallel line to this curve will intersect the appropriate power for the desired maximum T_J allowed.
2. Derate design curve constrained by the maximum junction temperatures and power rating specified. (See 1.3 herein.)
3. Derate design curve chosen at $T_J \leq +150^{\circ}\text{C}$, where the maximum temperature of electrical test is performed.
4. Derate design curve chosen at $T_J \leq +125^{\circ}\text{C}$, and $+110^{\circ}\text{C}$ to show power rating where most users want to limit T_J in their application.

* FIGURE 10. Temperature-power derating for UA package ($R_{\theta JSP(AM)}$) 4-point solder pad (adhesive mount to PCB).

MIL-PRF-19500/291Y
w/AMENDMENT 1

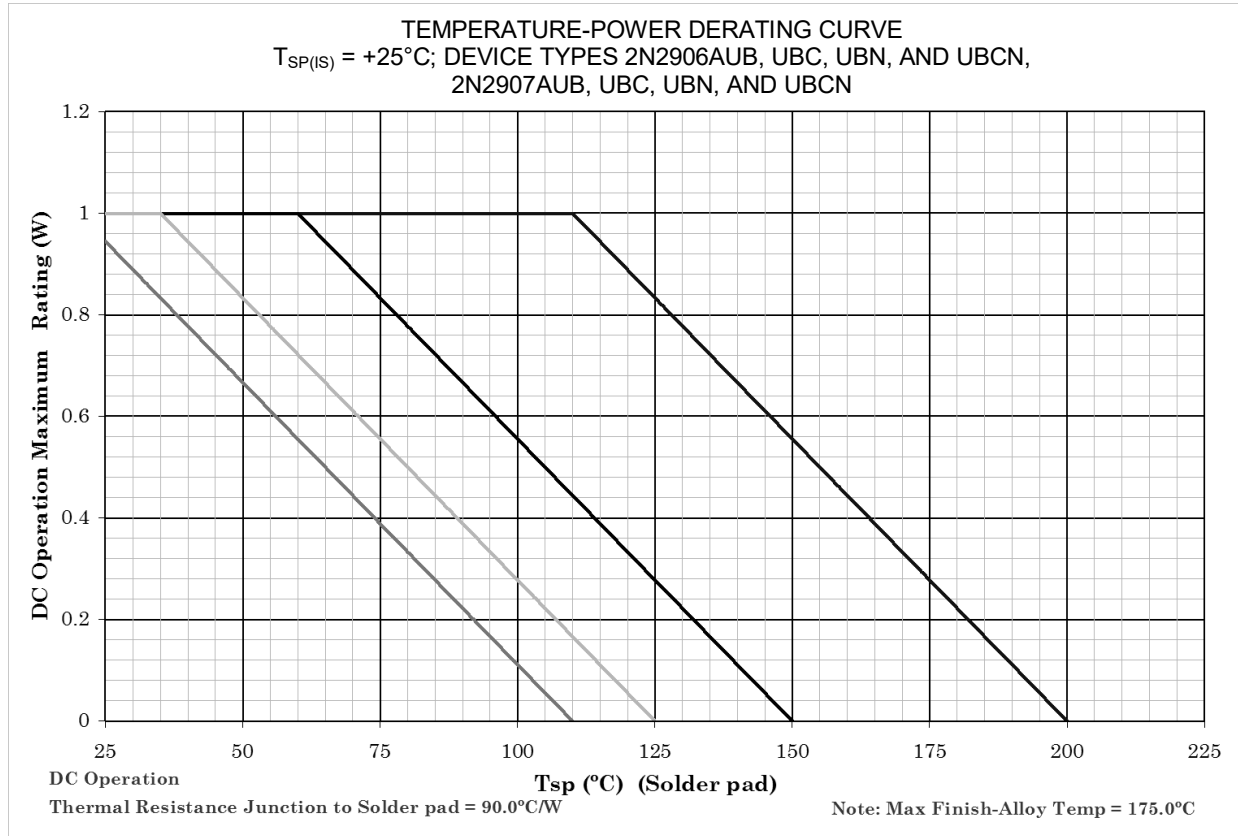

NOTES:

1. This is the true inverse of the worst case thermal resistance value. All devices are capable of operating at $\leq T_J$ specified on this curve. Any parallel line to this curve will intersect the appropriate power for the desired maximum T_J allowed.
2. Derate design curve constrained by the maximum junction temperatures and power rating specified. (See 1.3 herein.)
3. Derate design curve chosen at $T_J \leq +150^{\circ}\text{C}$, where the maximum temperature of electrical test is performed.
4. Derate design curve chosen at $T_J \leq +125^{\circ}\text{C}$, and $+110^{\circ}\text{C}$ to show power rating where most users want to limit T_J in their application.

* FIGURE 11. Temperature-power derating for UB, UBC, UBN, or UBCN packages ($R_{\theta JSP(1S)}$) infinite sink 3-point.

MAXIMUM THERMAL IMPEDANCE
DEVICE TYPES 2N2906A, 2N2906AL, 2N2907A, AND 2N2907AL;
TO-18 PACKAGE WITH .125" LEAD MOUNT TO PCB

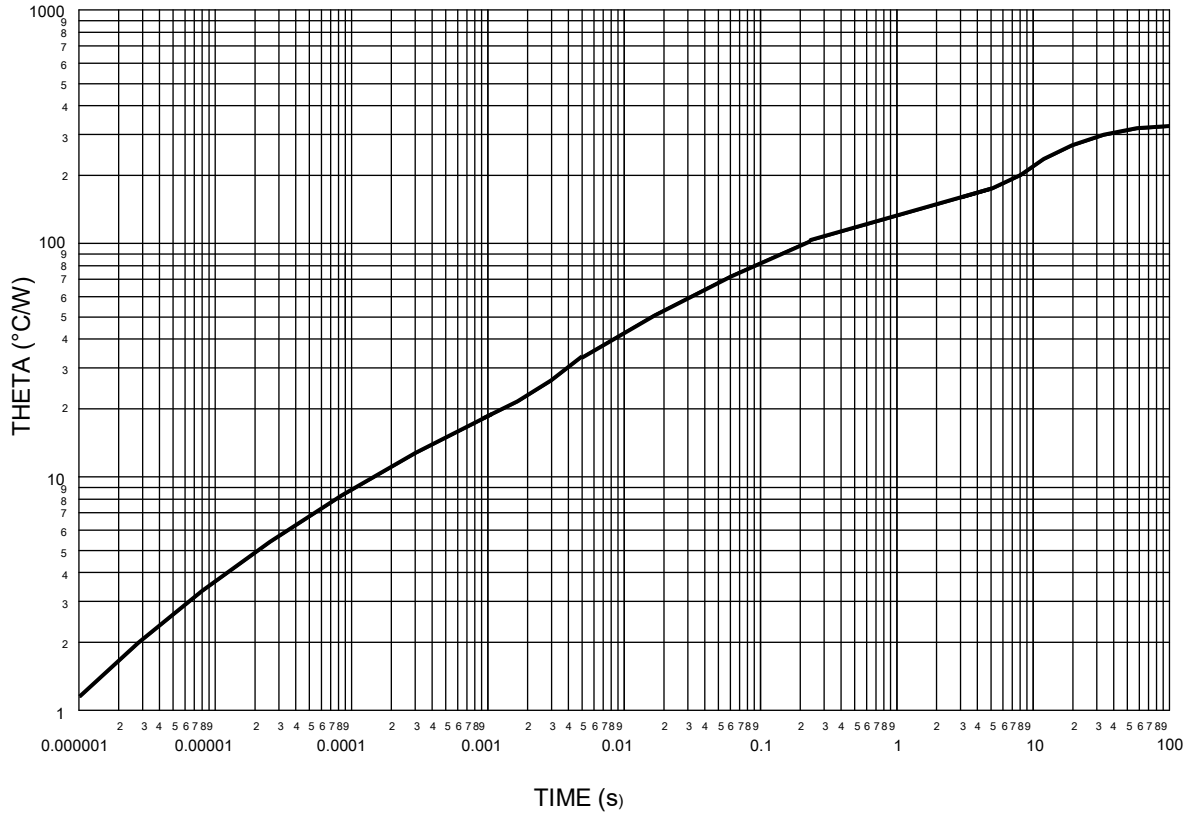

* FIGURE 12. Thermal impedance graph ($R_{\theta JA}$) for devices in a TO-206AA package.

MAXIMUM THERMAL IMPEDANCE
DEVICE TYPES 2N2906A, 2N2906AL, 2N2907A, AND 2N2907AL;
TO-18 PACKAGE WITH CASE BASE IN COPPER SINK

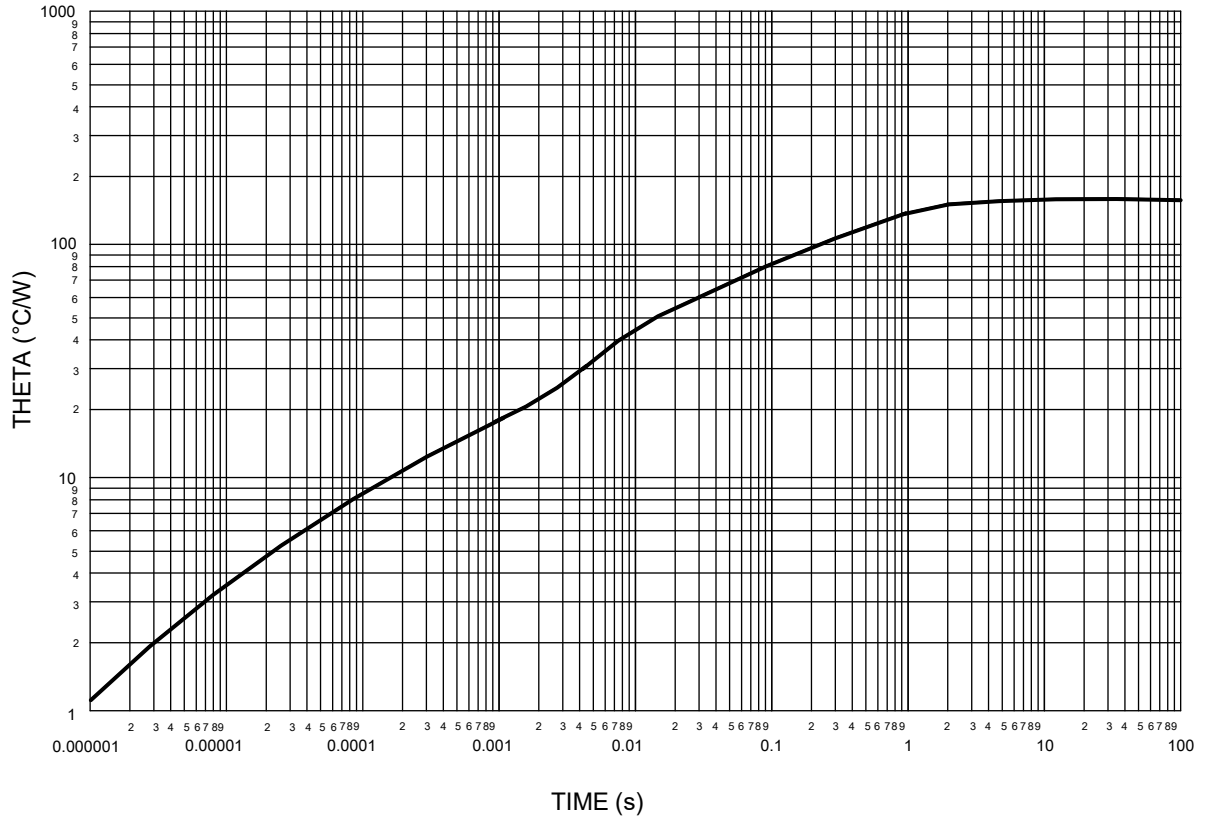

* FIGURE 13. Thermal impedance graph ($R_{\theta JC}$) for devices in TO-206AA package.

MAXIMUM THERMAL IMPEDANCE
DEVICE TYPES 2N2906AUA AND 2N2907AUA;
UA PACKAGE 4 POINTS SOLDER PADS (INFINITE SINK MOUNT TO PCB)

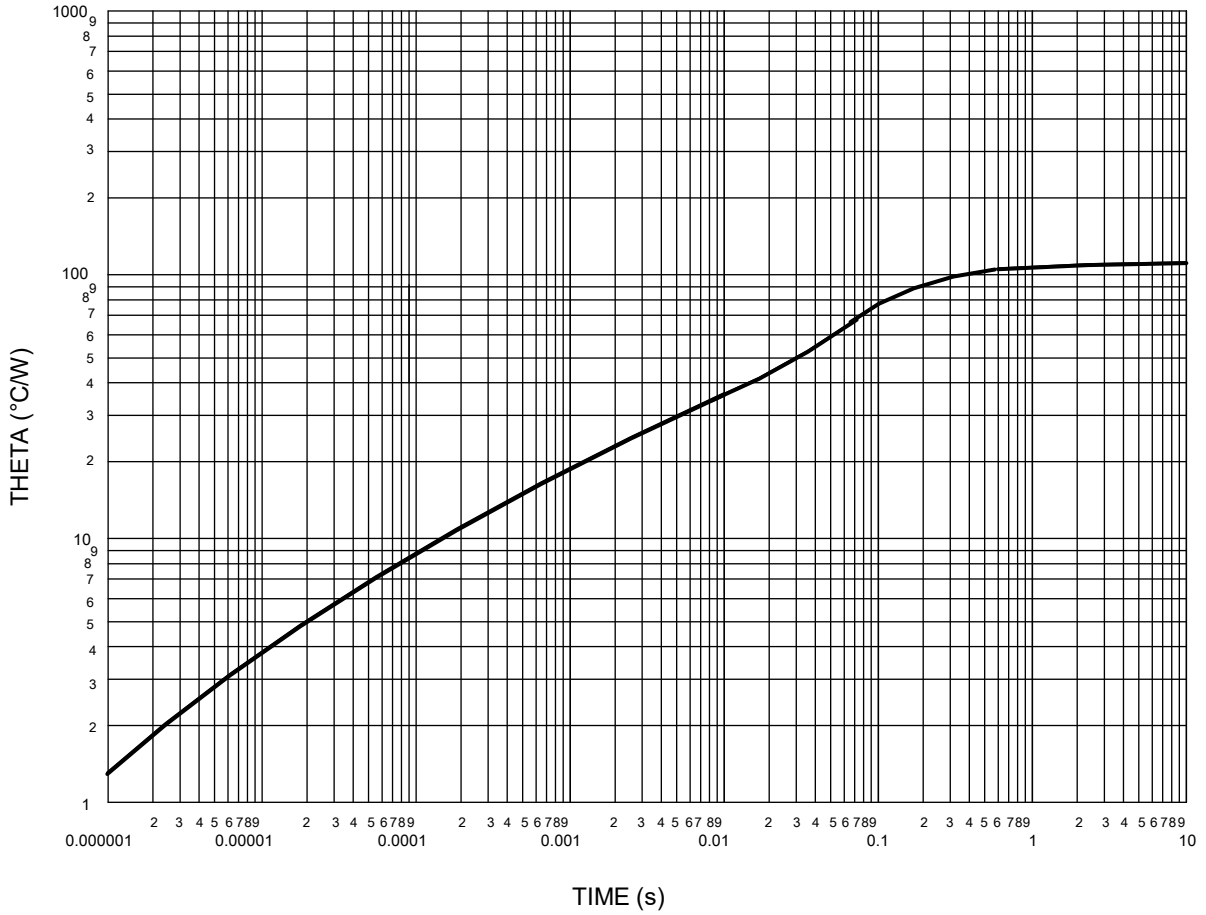

* FIGURE 14. Thermal impedance graph ($R_{\theta JSP(t)}$) for devices in a UA package.

MAXIMUM THERMAL IMPEDANCE
DEVICE TYPES 2N2906AUA AND 2N2907AUA;
UA 4 POINTS SOLDER PADS (ADHESIVE MOUNT TO PCB)

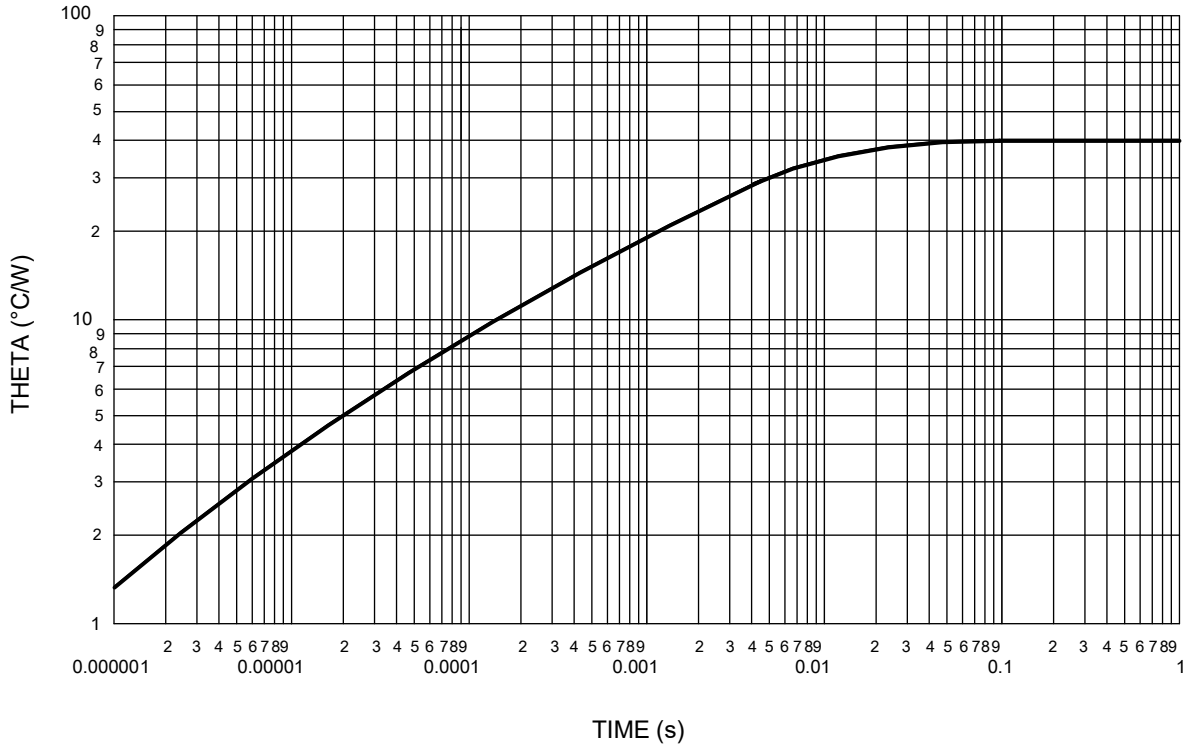

* FIGURE 15. Thermal impedance graph ($R_{\theta JSP(AM)}$) for devices in a UA package.

MAXIMUM THERMAL IMPEDANCE
DEVICE TYPES 2N2906AUB, 2N2906AUBC, 2N2907AUB AND 2N2907AUBC
UB AND UBC WITH 3 POINTS SOLDER PADS (INFINITE SINK MOUNT) TO PCB

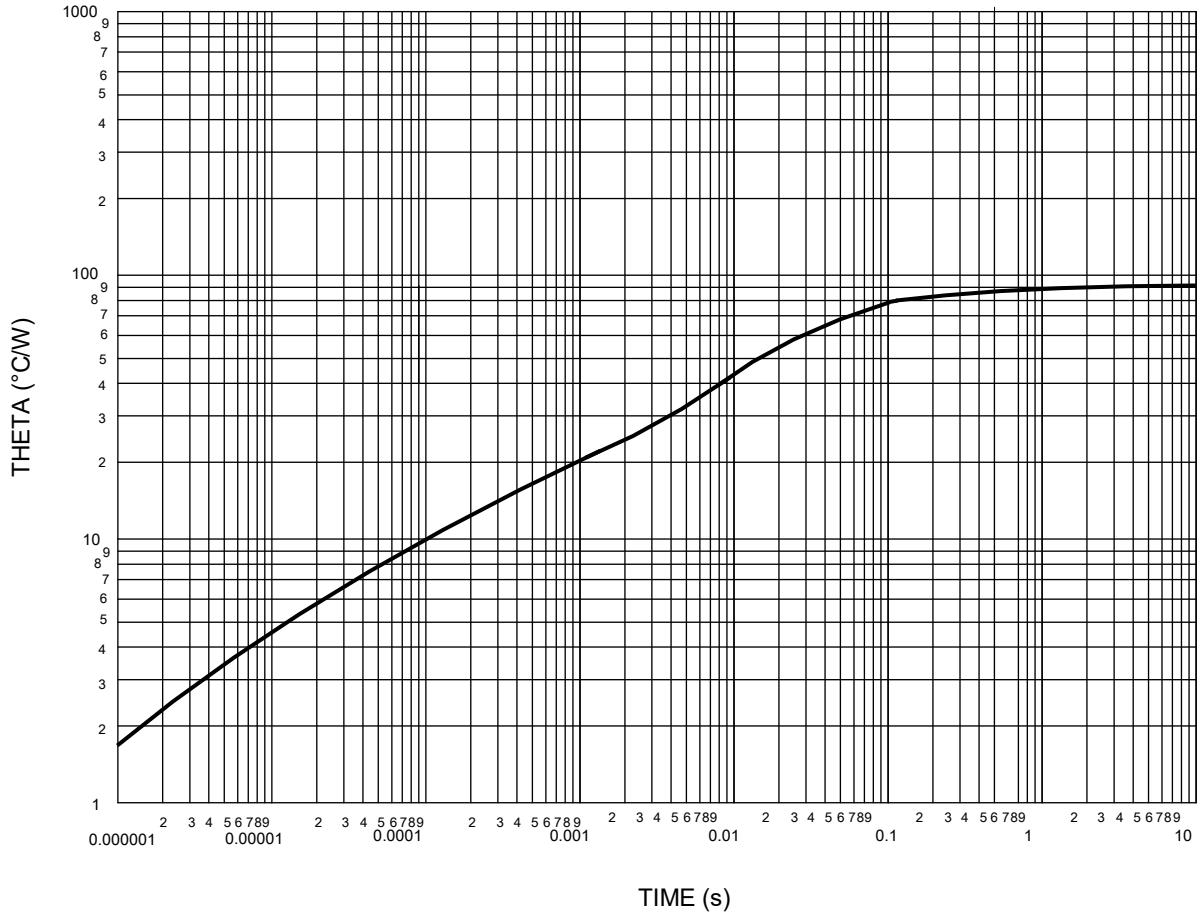

* FIGURE 16. Thermal impedance graph ($R_{\theta JSP(S)}$) for devices in a UB, UBC, UBN, and UBCN package).

MIL-PRF-19500/291Y
w/AMENDMENT 1

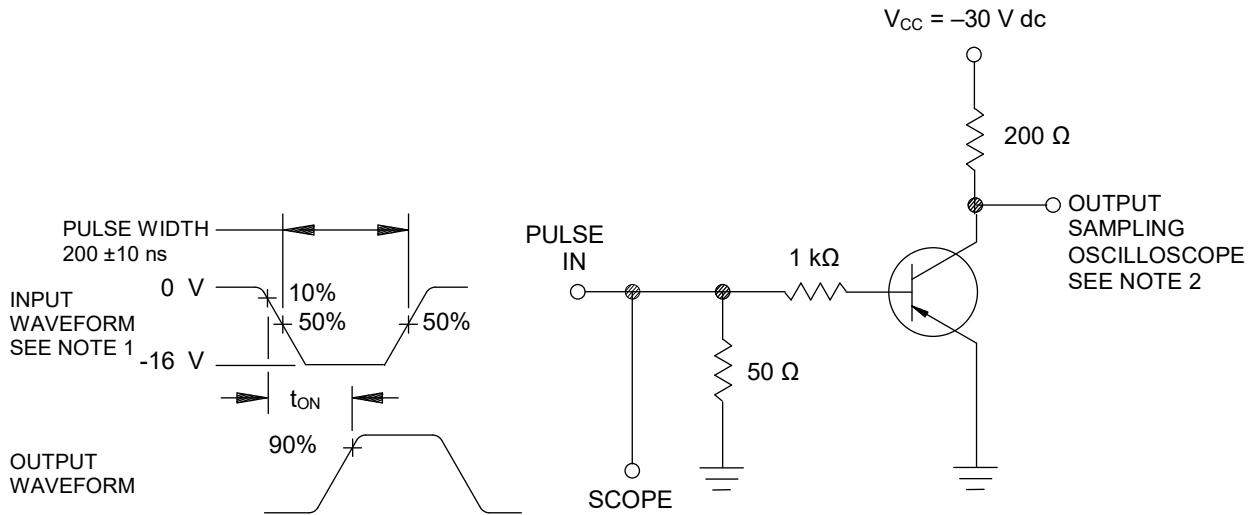

NOTES:

1. The rise time (t_r) of the applied pulse shall be ≤ 2.0 ns, duty cycle ≤ 2 percent and the generator source impedance shall be 50 ohms.
2. Sampling oscilloscope: $Z_{in} \geq 100$ K ohms, $C_{in} \leq 12$ pF, rise time ≤ 5 ns.

* FIGURE 17. Saturated turn-on switching time test circuit.

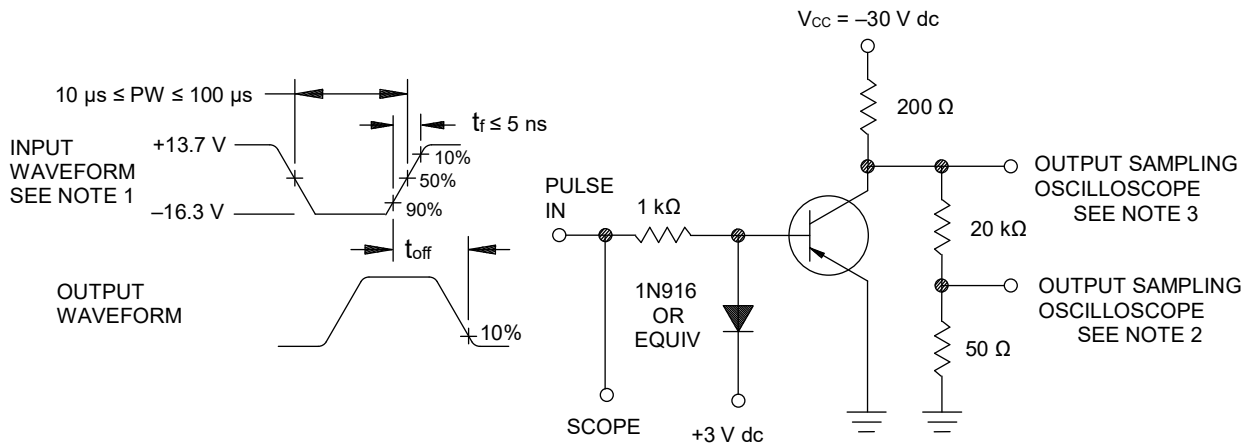

NOTES:

1. The rise time (t_r) of the applied pulse shall be ≤ 2.0 ns, duty cycle ≤ 2 percent and the generator source impedance shall be 50 ohms.
2. Sampling oscilloscope: $Z_{in} \geq 100$ K ohms, $C_{in} \leq 12$ pF, rise time ≤ 5 ns.
3. Alternate test point for high impedance attenuating probe.

* FIGURE 18. Saturated turn-off switching time test circuit.

5. PACKAGING

5.1 Packaging. For acquisition purposes, the packaging requirements shall be as specified in the contract or order (see 6.2). When packaging of materiel is to be performed by DoD or in-house contractor personnel, these personnel need to contact the responsible packaging activity to ascertain packaging requirements. Packaging requirements are maintained by the Inventory Control Point's packaging activities within the Military Service or Defense Agency, or within the Military Service's system commands. Packaging data retrieval is available from the managing Military Department's or Defense Agency's automated packaging files, CD-ROM products, or by contacting the responsible packaging activity.

6. NOTES

(This section contains information of a general or explanatory nature that may be helpful, but is not mandatory. The notes specified in MIL-PRF-19500 are applicable to this specification.)

6.1 Intended use. Semiconductors conforming to this specification are intended for original equipment design applications and logistic support of existing equipment.

6.2 Acquisition requirements. Acquisition documents should specify the following:

- a. Title, number, and date of this specification.
- b. Packaging requirements (see 5.1).
- c. Lead finish (see 3.4.1).
- d. The complete PIN, see 1.5 and 6.4.
- e. For acquisition of RHA designed devices, table II, subgroup 1 testing of group D is optional. If table II, subgroup 1 testing is desired, it must be specified in the contract.

6.3 Qualification. With respect to products requiring qualification, awards will be made only for products which are, at the time of award of contract, qualified for inclusion in Qualified Manufacturers List (QML 19500) whether or not such products have actually been so listed by that date. The attention of the contractors is called to these requirements, and manufacturers are urged to arrange to have the products that they propose to offer to the Federal Government tested for qualification in order that they may be eligible to be awarded contracts or orders for the products covered by this specification. Information pertaining to qualification of products may be obtained from DLA Land and Maritime, ATTN: VQE, P.O. Box 3990, Columbus, OH 43218-3990 or e-mail vqe.chief@dla.mil. An online listing of products qualified to this specification may be found in the Qualified Products Database (QPD) at <https://qpldocs.dla.mil>.

6.4 PIN construction examples. The PINs for encapsulated and unencapsulated devices and are constructed using the following forms.

6.4.1 Non-RHA encapsulated devices The PINs for encapsulated devices are constructed using the following form.

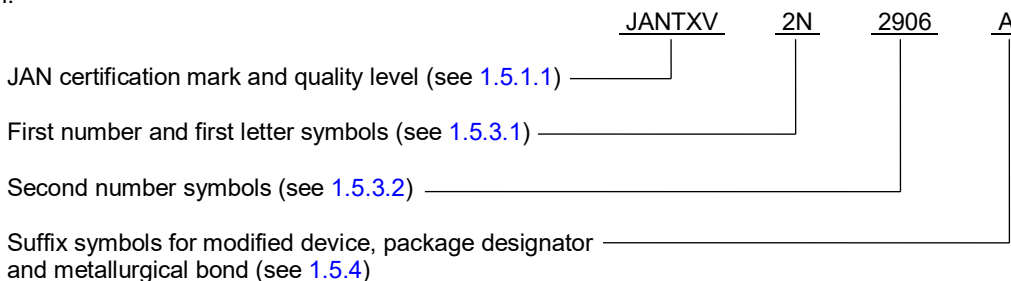

MIL-PRF-19500/291Y
w/AMENDMENT 1

6.4.2 RHA encapsulated devices The PINs for RHA encapsulated devices are constructed using the following form.

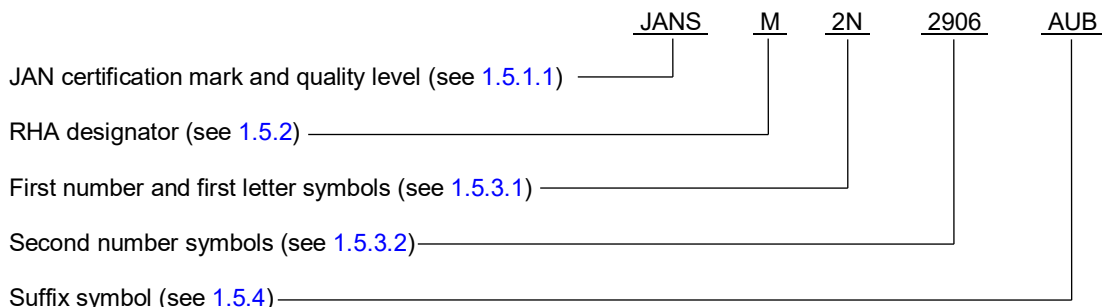

6.4.3 Unencapsulated devices. The PINs for un-encapsulated devices are constructed using the following form.

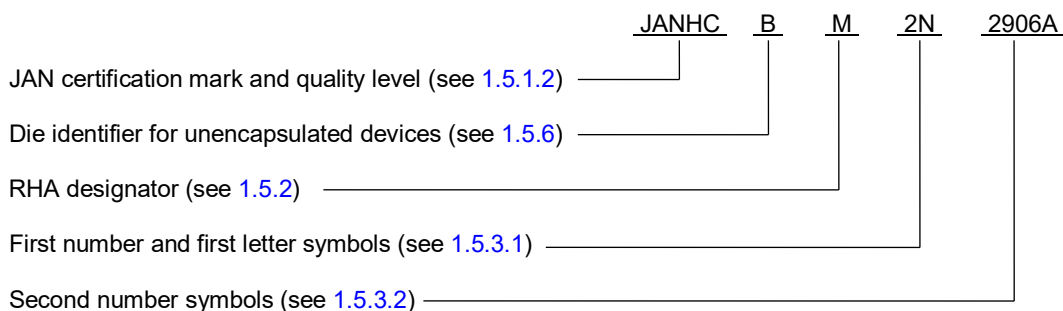

6.5 List of PINs.

6.5.1 PINs for encapsulated devices. The following is a list of possible PINs for encapsulated devices available on this specification sheet.

PINs for type 2N2906A and 2N2907A (1)			
JAN2N2906A	JANTX2N2906A	JANTXV#2N2906A	JANS#2N2906A
JAN2N2906AL	JANTX2N2906AL	JANTXV#2N2906AL	JANS#2N2906AL
JAN2N2907A	JANTX2N2907A	JANTXV#2N2907A	JANS#2N2907A
JAN2N2907AL	JANTX2N2907AL	JANTXV#2N2907AL	JANS#2N2907AL
JAN2N2906AUA	JANTX2N2906AUA	JANTXV#2N2906AUA	JANS#2N2906AUA
JAN2N2907AUA	JANTX2N2907AUA	JANTXV#2N2907AUA	JANS#2N2907AUA
JAN2N2906AUB	JANTX2N2906AUB	JANTXV#2N2906AUB	JANS#2N2906AUB
JAN2N2906AUBC	JANTX2N2906AUBC	JANTXV#2N2906AUBC	JANS#2N2906AUBC
JAN2N2907AUB	JANTX2N2907AUB	JANTXV#2N2907AUB	JANS#2N2907AUB
JAN2N2907AUBC	JANTX2N2907AUBC	JANTXV#2N2907AUBC	JANS#2N2907AUBC
JAN2N2906AUBN	JANTX2N2906AUBN	JANTXV#2N2906AUBN	JANS#2N2906AUBN
JAN2N2906AUBCN	JANTX2N2906AUBCN	JANTXV#2N2906AUBCN	JANS#2N2906AUBCN
JAN2N2907AUBN	JANTX2N2907AUBN	JANTXV#2N2907AUBN	JANS#2N2907AUBN
JAN2N2907AUBCN	JANTX2N2907AUBCN	JANTXV#2N2907AUBCN	JANS#2N2907AUBCN

(1) The number sign (#) represent one of eight RHA designators available (M, D, P, L, R, F, G, or H). The PIN is also available without a RHA designator.

MIL-PRF-19500/291Y
w/AMENDMENT 1

6.5.2 List of PINs for unencapsulated devices. The following is a list of possible PINs available on this specification sheet.

PINs for type 2N2906A and 2N2907A (1)	
JANHCB#2N2906A	JANHCD#2N2906A
JANKCB#2N2907A	JANKCD#2N2907A

(1) The number sign (#) represent one of eight RHA designators available (M, D, P, L, R, F, G, or H). The PIN is also available without a RHA designator.

* 6.5.3 Suppliers and PINs for JANHC and JANKC die. The qualified JANHC and JANKC suppliers with the applicable letter version (example JANHCB2N2907A) will be identified on the QML.

Die ordering information (1) (2)			
PIN	Manufacturer		
	43611	34156	9N185
2N2906A	JANHCB2N2906A	JANHCD2N2906A	JANHCE2N2906A
2N2907A	JANHCB2N2907A	JANHCD2N2907A	JANHCE2N2907A

(1) For JANKC level, replace JANHC with JANKC.
(2) JANHCA, JANKCA, JANHCC, and JANKCC versions are obsolete.

6.6 Supersession information.

6.6.1 Superseded PINs. The following supersession data applies to PINs associated with this document:

Superseding PIN as specified within MIL-S-19500/291E, dated 28 July 1994	Superseded PIN as specified within MIL-S-19500/291D, AMENDMENT 3, dated 5 March 1993	Superseding PIN as specified within MIL-S-19500/314A(USAF), AMENDMENT 1, dated 3 March 1966
2N2906A	2N2906	
2N2907A	2N2907	2N2907A

6.6.2 Commerical PINs. Devices covered by this specification supersede the manufacturers' and users' PIN. The term PIN is equivalent to the term part number which was previously used in this specification. This information in no way implies that manufacturers' PIN's are suitable as a substitute for the military PIN.

6.7 Request for new types and configurations. Requests for new device types or configurations for inclusions in this specification sheet should be submitted to: DLA Land and Maritime, ATTN: VAC, Post Office Box 3990, Columbus, OH 43218-3990 or by electronic mail at Semiconductor@dla.mil or by facsimile (614) 693-1642 or DSN 850-6939.

MIL-PRF-19500/291Y
w/AMENDMENT 1

* 6.8 Amendment notations. The margins of this specification are marked with asterisks to indicate modifications generated by this amendment. This was done as a convenience only and the Government assumes no liability whatsoever for any inaccuracies in these notations. Bidders and contractors are cautioned to evaluate the requirements of this document based on the entire content irrespective of the marginal notations and relationship to the last previous issue.

Custodians:
Army - CR
Navy - EC
Air Force - 85
NASA - NA
DLA - CC

Preparing activity:
DLA - CC

(Project 5961-2019-069)

Review activities:
Army - AR, MI, SM
Navy - AS, MC
Air Force - 19

NOTE: The activities listed above were interested in this document as of the date of this document. Since organizations and responsibilities can change, you should verify the currency of the information above using the ASSIST Online database at <https://assist.dla.mil>.