





# SMT Power Inductors

Unshielded Drum Core - PF0580NL Series



-  **Height:** 3.48mm Max
-  **Footprint:** 4.7mm Typ x 4.2mm Max
-  **Current Rating:** up to 3.1A
-  **Inductance Range:** 1 $\mu$ H to 65 $\mu$ H
-  **260°C reflow peak temperature qualified**

Electrical Specifications @ 25°C - Operating Temperature -40°C to +125°C<sup>6</sup>

Part <sup>5</sup> Number	Inductance <sup>1</sup> @ I <sub>rated</sub> ( $\mu$ H TYP)	I <sub>rated</sub> <sup>2</sup> (A)	DCR (MAX) (m $\Omega$ MAX)	Inductance @ 0A <sub>DC</sub> ( $\mu$ H $\pm$ 15%)	Saturation Current <sup>3</sup> I <sub>sat</sub> (A)	Heating Current <sup>4</sup> I <sub>bc</sub> (A)
PF0580.102NL	1.0	3.1	35	1.0	3.6	3.1
PF0580.152NL	1.4	2.7	40	1.5	2.7	2.7
PF0580.182NL *	1.7	2.4	45	1.8	2.4	2.6
PF0580.222NL	2.1	2.2	49	2.2	2.2	2.4
PF0580.272NL *	2.6	2.0	58	2.7	2.0	2.3
PF0580.332NL	3.1	1.8	63	3.3	1.8	2.25
PF0580.382NL	3.6	1.7	68	3.8	1.7	2.2
PF0580.472NL	4.5	1.6	77	4.7	1.6	2.0
PF0580.562NL	5.3	1.4	90	5.6	1.4	1.9
PF0580.682NL	6.5	1.3	100	6.8	1.3	1.8
PF0580.822NL	7.8	1.2	111	8.2	1.2	1.6
PF0580.103NL	9.5	1.1	132	10	1.1	1.5
PF0580.123NL	11	1.0	160	12	1.0	1.4
PF0580.153NL	14	0.85	197	15	0.85	1.3
PF0580.183NL *	17	0.80	255	18	0.80	1.1
PF0580.223NL	21	0.75	280	22	0.75	1.0
PF0580.273NL *	26	0.65	384	27	0.65	0.90
PF0580.333NL	31	0.58	427	33	0.58	0.85
PF0580.393NL	37	0.55	490	39	0.55	0.80
PF0580.473NL	45	0.50	645	47	0.50	0.70
PF0580.563NL	53	0.46	700	56	0.46	0.67
PF0580.683NL	65	0.41	827	68	0.41	0.62

## Mechanical

## Schematic

PF0580.XXXNL

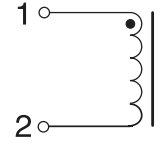
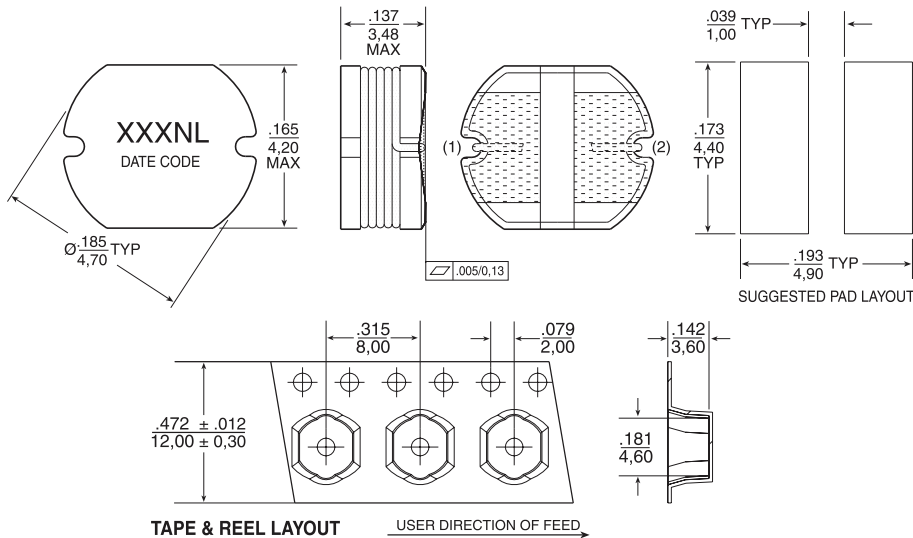

Weight .....6.0 grams  
Tape & Reel .....160/reel

Dimensions:  $\frac{\text{Inches}}{\text{mm}}$

Unless otherwise specified,  
all tolerances are  $\pm \frac{.004}{0,10}$

### Notes from Tables:

- Inductance at  $I_{rated}$  is a typical inductance value measured when the inductor is subjected to the rated current.
- The rated current listed is the lower of the saturation current @ 25°C or the heating current.
- The saturation current,  $I_{sat}$ , is the current at which the component inductance drops by 20% (maximum) at an ambient temperature of 25°C. This current is determined by placing the component in the specified ambient environment and applying a short duration pulse current (to eliminate self-heating effects) to the component.
- The heating current,  $I_{hc}$ , is the DC current required to raise the component temperature by approximately 40°C. The heating current is determined by mounting the component on a typical PCB and applying current for 30 minutes.
- Optional Tape & Reel packaging can be ordered by adding a "T" suffix to the part number (i.e. PF0504.681NL becomes PF0504.681NLT). Pulse complies to industry standard tape and reel specification EIA481.
- The temperature of the component (ambient plus temperature rise) must be within the stated operating temperature range.

\* Contact Pulse for availability

## Typical Inductance vs Current Characteristics

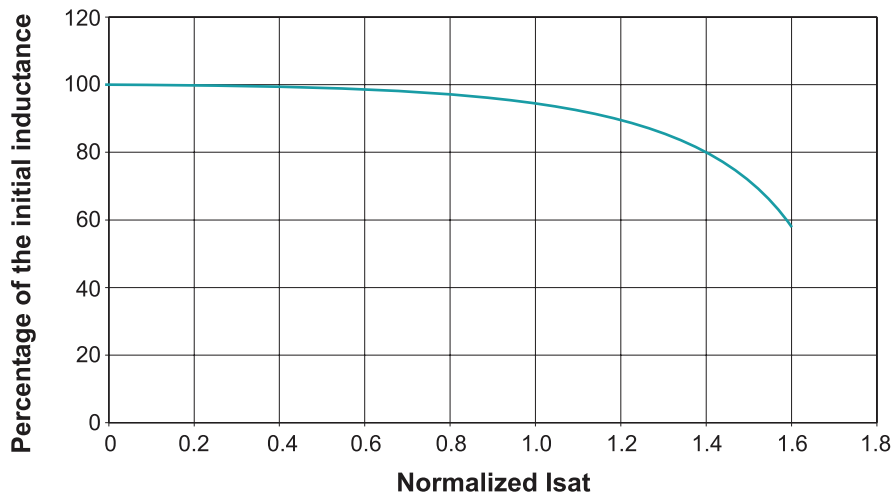

# SMT Power Inductors

Unshielded Drum Core - PF0580NL Series



---

## For More Information

### Pulse Worldwide Headquarters

15255 Innovation Drive Ste 100  
San Diego, CA 92128  
U.S.A.

Tel: 858 674 8100  
Fax: 858 674 8262

### Pulse Europe

Pulse Electronics GmbH  
Am Rottland 12  
58540 Meinerzhagen  
Germany

Tel: 49 2354 777 100  
Fax: 49 2354 777 168

### Pulse China Headquarters

Pulse Electronics (ShenZhen) CO., LTD  
D708, Shenzhen Academy of  
Aerospace Technology,  
The 10th Keji South Road,  
Nanshan District, Shenzhen,  
P.R. China 518057

Tel: 86 755 33966678  
Fax: 86 755 33966700

### Pulse North China

Room 2704/2705  
Super Ocean Finance Ctr.  
2067 Yan An Road West  
Shanghai 200336  
China

Tel: 86 21 62787060  
Fax: 86 2162786973

### Pulse South Asia

3 Fraser Street 0428  
DUO Tower  
Singapore 189352

Tel: 65 6287 8998  
Fax: 65 6280 0080

### Pulse North Asia

1F., No.111 Xiyuan Road  
Zhongli District  
Taoyuan City 32057  
Taiwan (R.O.C)

Tel: 886 3 4356768  
Fax: 886 3 4356820

Performance warranty of products offered on this data sheet is limited to the parameters specified. Data is subject to change without notice. Other brand and product names mentioned herein may be trademarks or registered trademarks of their respective owners. © Copyright, 2019. Pulse Electronics, Inc. All rights reserved.