

Features

- $BV_{CEO} > -15V$
- $I_C = -500mA$ High Collector Current
- $I_{CM} = -1A$ Peak Pulse Current
- $P_D = 1000mW$ Power Dissipation
- Low Collector-Emitter Saturation Voltage, $V_{CE(sat)}$
- $0.60mm^2$ Package Footprint, 13 Times Smaller than SOT23
- 0.5mm Height Package Minimizing Off-Board Profile
- Complementary NPN Type DIODES™ DSS2515M
- **Totally Lead-Free & Fully RoHS Compliant (Notes 1 & 2)**
- **Halogen and Antimony Free. "Green" Device (Note 3)**
- **This part is qualified to JEDEC standards (as references in AEC-Q) for High Reliability.**
<https://www.diodes.com/quality/product-definitions/>
- **An automotive-compliant part is available under separate datasheet ([DSS3515MQ](#))**

Mechanical Data

- Package: X1-DFN1006-3
- Package Material: Molded Plastic, "Green" Molding Compound. UL Flammability Classification Rating 94V-0
- Moisture Sensitivity: Level 1 per J-STD-020
- Terminals: Finish – NiPdAu. Solderable per MIL-STD-202, Method 208 (e4)
- Weight: 0.0009 grams (Approximate)

X1-DFN1006-3

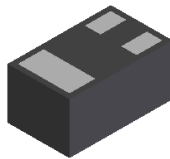

Bottom View

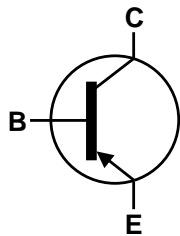

Device Symbol

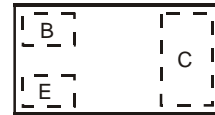

Top View
Device Schematic

Ordering Information (Note 4)

Part Number	Package	Marking	Reel Size (inches)	Tape Width (mm)	Packing	
					Qty.	Carrier
DSS3515M-7	X1-DFN1006-3	TB	7	8	3,000	Reel
DSS3515M-7B	X1-DFN1006-3	TB	7	8	10,000	Reel

- Notes:
1. No purposely added lead. Fully EU Directive 2002/95/EC (RoHS), 2011/65/EU (RoHS 2) & 2015/863/EU (RoHS 3) compliant.
 2. See <https://www.diodes.com/quality/lead-free/> for more information about Diodes Incorporated's definitions of Halogen- and Antimony-free, "Green" and Lead-free.
 3. Halogen- and Antimony-free "Green" products are defined as those which contain <900ppm bromine, <900ppm chlorine (<1500ppm total Br + Cl) and <1000ppm antimony compounds.
 4. For packaging details, go to our website at <https://www.diodes.com/design/support/packaging/diodes-packaging/>.

Marking Information

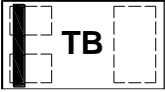
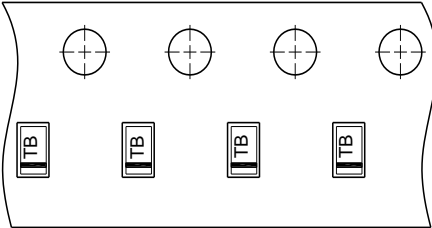
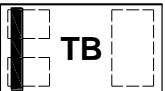
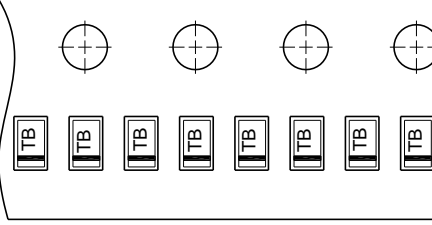
<p>DSS3515M-7</p>	 <p>TB = Product Type Marking Code</p> <p>Top View Bar Denotes Base and Emitter Side</p> 
<p>DSS3515M-7B</p>	 <p>TB = Product Type Marking Code</p> <p>Top View Bar Denotes Base and Emitter Side</p> 

Absolute Maximum Ratings (@T_A = +25°C, unless otherwise specified.)

Characteristic	Symbol	Value	Unit
Collector-Base Voltage	V _{CBO}	-15	V
Collector-Emitter Voltage	V _{CEO}	-15	V
Emitter-Base Voltage	V _{EBO}	-6	V
Collector Current - Continuous	I _C	-500	mA
Peak Pulse Collector Current	I _{CM}	-1	A
Peak Base Current	I _{BM}	-100	mA

Thermal Characteristics (@T_A = +25°C, unless otherwise specified.)

Characteristic	Symbol	Value	Unit
Power Dissipation	P _D	(Note 5)	400
		(Note 6)	1000
Thermal Resistance, Junction to Ambient	R _{θJA}	(Note 5)	310
		(Note 6)	120
Thermal Resistance, Junction to Lead	R _{θJL}	120	°C/W
Operating and Storage and Temperature Range	T _J , T _{STG}	-55 to +150	°C

ESD Ratings (Note 8)

Characteristic	Symbol	Value	Unit	JEDEC Class
Electrostatic Discharge - Human Body Model	ESD HBM	4,000	V	3A
Electrostatic Discharge - Machine Model	ESD MM	200	V	B

- Notes:
5. For the device mounted on minimum recommended pad layout 2oz copper that is on a single-sided 1.6mm FR4 PCB; device is measured under still air conditions whilst operating in steady state condition.
 6. Same as Note 5, except the exposed collector pad is mounted on 25mm x 25mm 2oz copper.
 7. Thermal resistance from junction to solder-point (on the exposed collector pad).
 8. Refer to JEDEC specification JESD22-A114 and JESD22-A115.

Thermal Characteristics

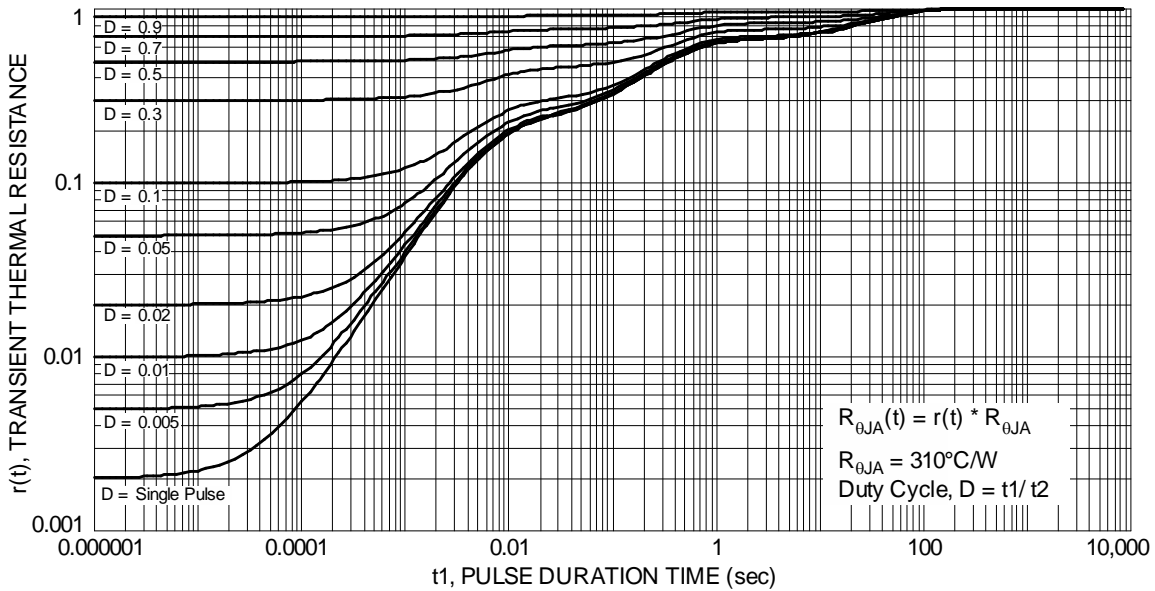

Fig. 1 Transient Thermal Resistance

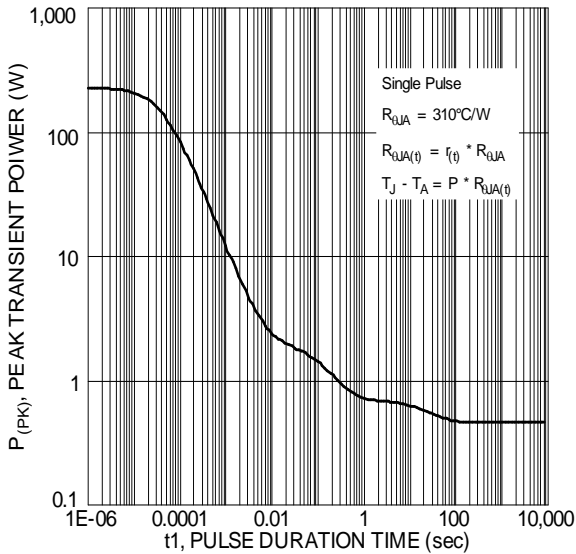

Fig. 2 Single Pulse Maximum Power Dissipation

Electrical Characteristics (@T_A = +25°C, unless otherwise specified.)

Characteristic	Symbol	Min	Typ	Max	Unit	Test Condition
OFF CHARACTERISTICS						
Collector-Base Breakdown Voltage	BV _{CB0}	-15	—	—	V	I _C = -100μA, I _E = 0
Collector-Emitter Breakdown Voltage (Note 9)	BV _{CEO}	-15	—	—	V	I _C = -10mA, I _B = 0
Emitter-Base Breakdown Voltage	BV _{EB0}	-6	—	—	V	I _E = -100μA, I _C = 0
Collector Cutoff Current	I _{CB0}	—	—	-100 -50	nA μA	V _{CB} = -15V, I _E = 0 V _{CB} = -15V, I _E = 0, T _A = +150°C
Emitter Cutoff Current	I _{EB0}	—	—	-100	nA	V _{EB} = -5V, I _C = 0
ON CHARACTERISTICS (Note 9)						
DC Current Gain	h _{FE}	200 150 90	— — —	— — —	—	V _{CE} = -2V, I _C = -10mA V _{CE} = -2V, I _C = -100mA V _{CE} = -2V, I _C = -500mA
Collector-Emitter Saturation Voltage	V _{CE(sat)}	— — —	— — —	-25 -150 -250	mV	I _C = -10mA, I _B = -0.5mA I _C = -200mA, I _B = -10mA I _C = -500mA, I _B = -50mA
Collector-Emitter Saturation Resistance	R _{CE(sat)}	—	—	500	mΩ	I _C = -500mA, I _B = -50mA
Base-Emitter Saturation Voltage	V _{BE(sat)}	—	—	-1.1	V	I _C = -500mA, I _B = -50mA
Base-Emitter Turn On Voltage	V _{BE(on)}	—	—	-0.9	V	V _{CE} = -2V, I _C = -100mA
SMALL SIGNAL CHARACTERISTICS						
Output Capacitance	C _{obo}	—	—	10	pF	V _{CB} = -10V, f = 1.0MHz
Current Gain-Bandwidth Product	f _T	100	340	—	MHz	V _{CE} = -5V, I _C = -100mA, f = 100MHz

Note: 9. Measured under pulsed conditions. Pulse width ≤ 300μs. Duty cycle ≤ 2%.

Typical Electrical Characteristics (@ $T_A = +25^\circ\text{C}$, unless otherwise specified.)

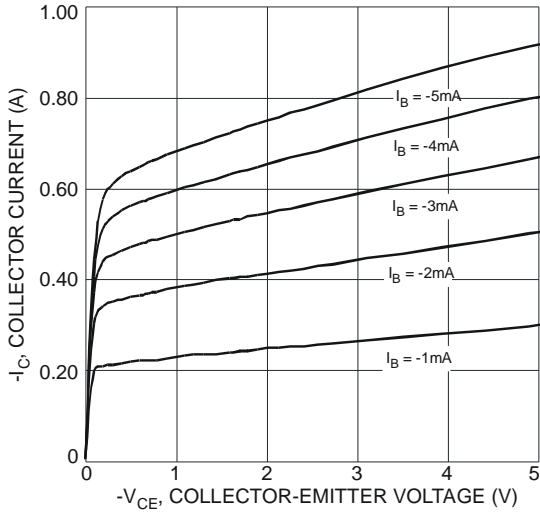

Fig. 3 Typical Collector Current vs. Collector-Emitter Voltage

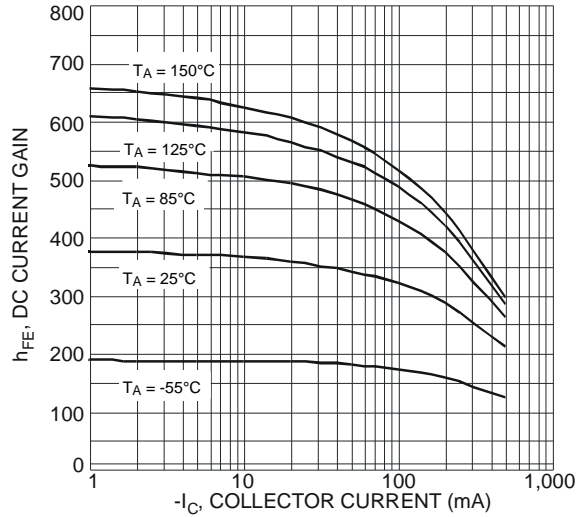

Fig. 4 Typical DC Current Gain vs. Collector Current

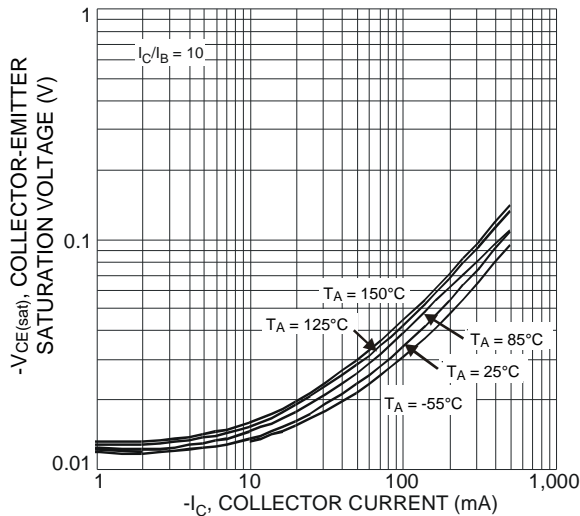

Fig. 5 Typical Collector-Emitter Saturation Voltage vs. Collector Current

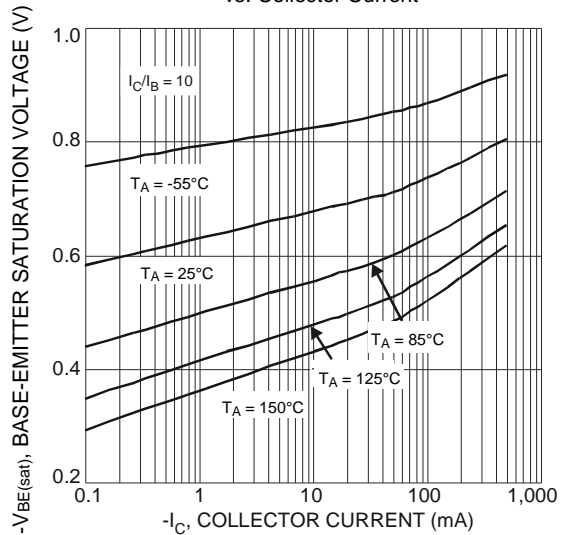

Fig. 6 Typical Base-Emitter Saturation Voltage vs. Collector Current

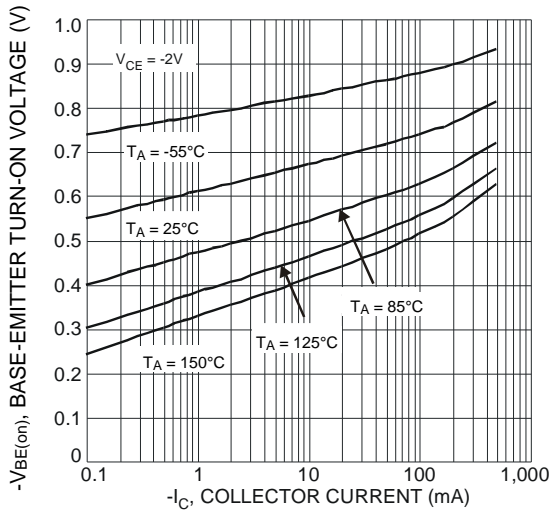

Fig. 7 Typical Base-Emitter Turn-On Voltage vs. Collector Current

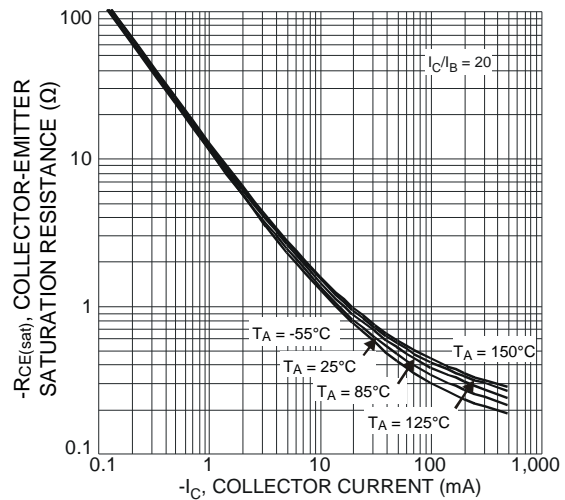
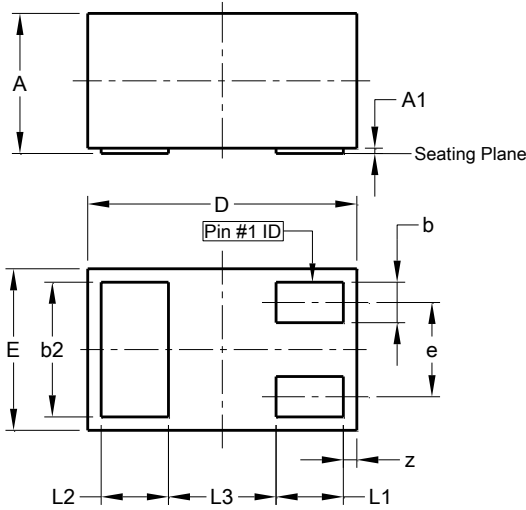

Fig. 8 Typical Collector-Emitter Saturation Resistance vs. Collector Current

Package Outline Dimensions

Please see <http://www.diodes.com/package-outlines.html> for the latest version.

X1-DFN1006-3



X1-DFN1006-3			
Dim	Min	Max	Typ
A	0.47	0.53	0.50
A1	0.00	0.05	0.03
b	0.10	0.20	0.15
b2	0.45	0.55	0.50
D	0.95	1.075	1.00
E	0.55	0.675	0.60
e	-	-	0.35
L1	0.20	0.30	0.25
L2	0.20	0.30	0.25
L3	-	-	0.40
z	0.02	0.08	0.05
All Dimensions in mm			

Suggested Pad Layout

Please see <http://www.diodes.com/package-outlines.html> for the latest version.

X1-DFN1006-3

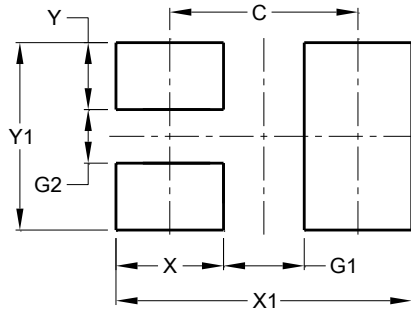

Dimensions	Value (in mm)
C	0.70
G1	0.30
G2	0.20
X	0.40
X1	1.10
Y	0.25
Y1	0.70

IMPORTANT NOTICE

1. DIODES INCORPORATED (Diodes) AND ITS SUBSIDIARIES MAKE NO WARRANTY OF ANY KIND, EXPRESS OR IMPLIED, WITH REGARDS TO ANY INFORMATION CONTAINED IN THIS DOCUMENT, INCLUDING, BUT NOT LIMITED TO, THE IMPLIED WARRANTIES OF MERCHANTABILITY, FITNESS FOR A PARTICULAR PURPOSE OR NON-INFRINGEMENT OF THIRD PARTY INTELLECTUAL PROPERTY RIGHTS (AND THEIR EQUIVALENTS UNDER THE LAWS OF ANY JURISDICTION).
2. The Information contained herein is for informational purpose only and is provided only to illustrate the operation of Diodes' products described herein and application examples. Diodes does not assume any liability arising out of the application or use of this document or any product described herein. This document is intended for skilled and technically trained engineering customers and users who design with Diodes' products. Diodes' products may be used to facilitate safety-related applications; however, in all instances customers and users are responsible for (a) selecting the appropriate Diodes products for their applications, (b) evaluating the suitability of Diodes' products for their intended applications, (c) ensuring their applications, which incorporate Diodes' products, comply the applicable legal and regulatory requirements as well as safety and functional-safety related standards, and (d) ensuring they design with appropriate safeguards (including testing, validation, quality control techniques, redundancy, malfunction prevention, and appropriate treatment for aging degradation) to minimize the risks associated with their applications.
3. Diodes assumes no liability for any application-related information, support, assistance or feedback that may be provided by Diodes from time to time. Any customer or user of this document or products described herein will assume all risks and liabilities associated with such use, and will hold Diodes and all companies whose products are represented herein or on Diodes' websites, harmless against all damages and liabilities.
4. Products described herein may be covered by one or more United States, international or foreign patents and pending patent applications. Product names and markings noted herein may also be covered by one or more United States, international or foreign trademarks and trademark applications. Diodes does not convey any license under any of its intellectual property rights or the rights of any third parties (including third parties whose products and services may be described in this document or on Diodes' website) under this document.
5. Diodes' products are provided subject to Diodes' Standard Terms and Conditions of Sale (<https://www.diodes.com/about/company/terms-and-conditions/terms-and-conditions-of-sales/>) or other applicable terms. This document does not alter or expand the applicable warranties provided by Diodes. Diodes does not warrant or accept any liability whatsoever in respect of any products purchased through unauthorized sales channel.
6. Diodes' products and technology may not be used for or incorporated into any products or systems whose manufacture, use or sale is prohibited under any applicable laws and regulations. Should customers or users use Diodes' products in contravention of any applicable laws or regulations, or for any unintended or unauthorized application, customers and users will (a) be solely responsible for any damages, losses or penalties arising in connection therewith or as a result thereof, and (b) indemnify and hold Diodes and its representatives and agents harmless against any and all claims, damages, expenses, and attorney fees arising out of, directly or indirectly, any claim relating to any noncompliance with the applicable laws and regulations, as well as any unintended or unauthorized application.
7. While efforts have been made to ensure the information contained in this document is accurate, complete and current, it may contain technical inaccuracies, omissions and typographical errors. Diodes does not warrant that information contained in this document is error-free and Diodes is under no obligation to update or otherwise correct this information. Notwithstanding the foregoing, Diodes reserves the right to make modifications, enhancements, improvements, corrections or other changes without further notice to this document and any product described herein. This document is written in English but may be translated into multiple languages for reference. Only the English version of this document is the final and determinative format released by Diodes.
8. Any unauthorized copying, modification, distribution, transmission, display or other use of this document (or any portion hereof) is prohibited. Diodes assumes no responsibility for any losses incurred by the customers or users or any third parties arising from any such unauthorized use.
9. This Notice may be periodically updated with the most recent version available at <https://www.diodes.com/about/company/terms-and-conditions/important-notice>

The Diodes logo is a registered trademark of Diodes Incorporated in the United States and other countries.
DIODES is a trademark of Diodes Incorporated in the United States and other countries.
All other trademarks are the property of their respective owners.
© 2023 Diodes Incorporated. All Rights Reserved.

www.diodes.com