



8-Channel, 24-Bit ANALOG-TO-DIGITAL CONVERTER

FEATURES

- 24 BITS NO MISSING CODES
- INL: 0.0012% of FSR (max)
- FULL-SCALE INPUT: $\pm 2V_{REF}$
- PGA FROM 1 TO 128
- 22 BITS EFFECTIVE RESOLUTION (PGA = 1), 19 BITS (PGA = 128)
- SINGLE CYCLE SETTLING MODE
- PROGRAMMABLE DATA OUTPUT RATES UP TO 1kHz
- ON-CHIP 1.25V/2.5V REFERENCE
- ON-CHIP CALIBRATION
- SPI COMPATIBLE
- POWER SUPPLY: 2.7V to 5.25V
- < 1mW POWER CONSUMPTION, $V_{DD} = 3V$

APPLICATIONS

- INDUSTRIAL PROCESS CONTROL
- LIQUID/GAS CHROMATOGRAPHY
- BLOOD ANALYSIS
- SMART TRANSMITTERS
- PORTABLE INSTRUMENTATION
- WEIGH SCALES
- PRESSURE TRANSDUCERS

DESCRIPTION

The ADS1217 is a precision, wide dynamic range, delta-sigma, Analog-to-Digital (A/D) converter with 24-bit resolution operating from 2.7V to 5.25V supplies. The delta-sigma, A/D converter provides up to 24 bits of no missing code performance and effective resolution of 22 bits.

The eight input channels are multiplexed. Internal buffering can be selected to provide a very high input impedance for direct connection to transducers or low-level voltage signals. Burnout current sources are provided that allow for the detection of an open or shorted sensor. An 8-bit Digital-to-Analog Converter (DAC) provides an offset correction with a range of 50% of the FSR (Full-Scale Range).

The PGA (Programmable Gain Amplifier) provides selectable gains of 1 to 128 with an effective resolution of 19 bits at a gain of 128. The A/D conversion is accomplished with a 2nd-order, delta-sigma modulator and programmable sinc filter. The reference input is differential and can be used for ratiometric measurements. The onboard current DACs operate independently with the maximum current set by an external resistor.

The serial interface is SPI compatible. Eight bits of digital I/O are also provided that can be used for input or output. The ADS1217 is designed for high-resolution measurement applications in smart transmitters, industrial process control, weigh scales, chromatography, and portable instrumentation.

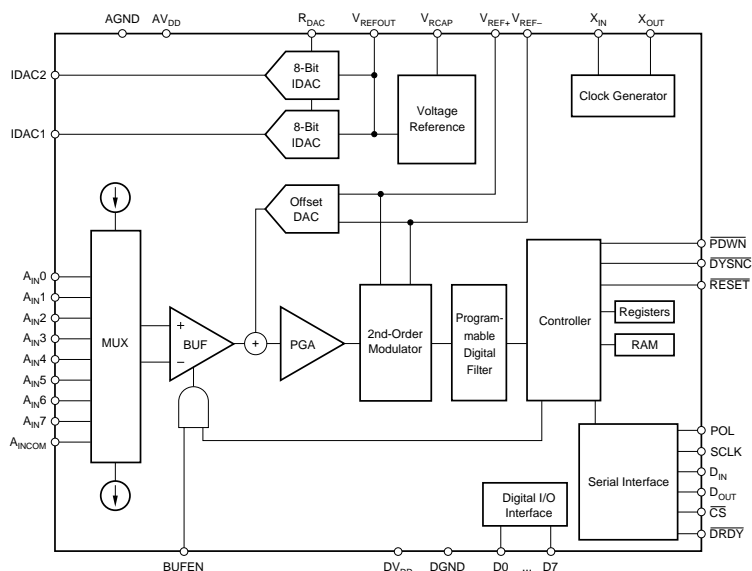

Please be aware that an important notice concerning availability, standard warranty, and use in critical applications of Texas Instruments semiconductor products and disclaimers thereto appears at the end of this data sheet.

All trademarks are the property of their respective owners.

PRODUCTION DATA information is current as of publication date. Products conform to specifications per the terms of Texas Instruments standard warranty. Production processing does not necessarily include testing of all parameters.

ABSOLUTE MAXIMUM RATINGS⁽¹⁾

AV _{DD} to AGND	-0.3V to +6V
DV _{DD} to DGND	-0.3V to +6V
Input Current	100mA, Momentary
Input Current	10mA, Continuous
A _{IN}	GND -0.5V to AV _{DD} + 0.5V
AV _{DD} to DV _{DD}	-6V to +6V
AGND to DGND	-0.3V to +0.3V
Digital Input Voltage to GND	-0.3V to DV _{DD} + 0.3V
Digital Output Voltage to GND	-0.3V to DV _{DD} + 0.3V
Maximum Junction Temperature	+150°C
Operating Temperature Range	-40°C to +85°C
Storage Temperature Range	-60°C to +150°C
Lead Temperature (soldering, 10s)	+300°C

NOTE: (1) Stresses above those listed under *Absolute Maximum Ratings* may cause permanent damage to the device. Exposure to absolute maximum conditions for extended periods may affect device reliability.



ELECTROSTATIC DISCHARGE SENSITIVITY

This integrated circuit can be damaged by ESD. Texas Instruments recommends that all integrated circuits be handled with appropriate precautions. Failure to observe proper handling and installation procedures can cause damage.

ESD damage can range from subtle performance degradation to complete device failure. Precision integrated circuits may be more susceptible to damage because very small parametric changes could cause the device not to meet its published specifications.

PACKAGE/ORDERING INFORMATION⁽¹⁾

PRODUCT	PACKAGE-LEAD	PACKAGE DESIGNATOR	SPECIFIED TEMPERATURE RANGE	PACKAGE MARKING	ORDERING NUMBER	TRANSPORT MEDIA, QUANTITY
ADS1217	TQFP-48	PFB	-40°C to +85°C	ADS1217	ADS1217IPFBT	Tape and Reel, 250
"	"	"	"	"	ADS1217IPFBR	Tape and Reel, 2000

NOTE: (1) For the most current package and ordering information, see the Package Option Addendum located at the end of this data sheet, or see the TI website at www.ti.com.

ELECTRICAL CHARACTERISTICS: AV_{DD} = 5V

All specifications at -40°C to +85°C, AV_{DD} = +5V, DV_{DD} = +2.7V to 5.25V, f_{MOD} = 19.2kHz, PGA = 1, Buffer ON, R_{DAC} = 150kΩ, f_{DATA} = 10Hz, and V_{REF} = +2.5V, unless otherwise specified.

PARAMETER	CONDITIONS	ADS1217			UNITS
		MIN	TYP	MAX	
ANALOG INPUT (A_{IN0} – A_{IN7}, A_{INCOM})					
Full-Scale Input Voltage	(A _{IN+}) – (A _{IN-})		±2V _{REF} /PGA		V
Analog Input Voltage	Buffer OFF	AGND – 0.1		AV _{DD} + 0.1	V
	Buffer ON	AGND + 0.05		AV _{DD} – 1.5	V
Differential Input Impedance	Buffer OFF		10/PGA		MΩ
Input Current	Buffer ON		0.5		nA
Bandwidth					
Fast Settling Filter	-3dB		0.469f _{DATA}		Hz
Sinc ² Filter	-3dB		0.318f _{DATA}		Hz
Sinc ³ Filter	-3dB		0.262f _{DATA}		Hz
Programmable Gain Amplifier	User Selectable Gain Ranges	1		128	
Burnout Current Sources			2		μA
OFFSET DAC					
Offset DAC Range			±V _{REF} /(PGA)		V
Offset DAC Monotonicity		8			Bits
Offset DAC Gain Error			±1		%
Offset DAC Gain Error Drift			1		ppm/°C
SYSTEM PERFORMANCE					
Resolution	Sinc ³ Filter	24		24	Bits
No Missing Codes	End Point Fit, Differential Input, Buffer Off		0.0003	0.0012	Bits
Integral Nonlinearity					% of FSR ⁽¹⁾
Offset Error	Before Calibration		7.5		ppm of FSR
Offset Drift			0.02		ppm of FSR/°C
Gain Error	After Calibration		0.005		%
Gain Error Drift			0.5		ppm/°C
Common-Mode Rejection	at DC	100			dB
	f _{CM} = 60Hz, f _{DATA} = 10Hz		130		dB
	f _{CM} = 50Hz, f _{DATA} = 50Hz		120		dB
	f _{CM} = 60Hz, f _{DATA} = 60Hz		120		dB
Normal-Mode Rejection	f _{SIG} = 50Hz, f _{DATA} = 50Hz		100		dB
	f _{SIG} = 60Hz, f _{DATA} = 60Hz		100		dB
Output Noise			See Typical Characteristics		dB
Power-Supply Rejection	at DC, dB = -20log(ΔV _{OUT} /ΔV _{DD}) ⁽²⁾	80	95		dB

NOTES: (1) FSR is Full-Scale Range. (2) ΔV_{OUT} is change in digital result. (3) 12pF switched capacitor at f_{SAMP} clock frequency.

ELECTRICAL CHARACTERISTICS: AV_{DD} = 5V (Cont.)

All specifications at -40°C to +85°C, AV_{DD} = +5V, DV_{DD} = +2.7V to 5.25V, f_{MOD} = 19.2kHz, PGA = 1, Buffer ON, R_{DAC} = 150kΩ, f_{DATA} = 10Hz, and V_{REF} = +2.5V, unless otherwise specified.

PARAMETER	CONDITIONS	ADS1217			UNITS
		MIN	TYP	MAX	
VOLTAGE REFERENCE INPUT					
Reference Input (V _{REF})	V _{REF} = (V _{REF+}) - (V _{REF-})	0.1	2.5	2.6	V
Negative Reference Input (V _{REF-})		AGND - 0.1		(V _{REF+}) - 0.1	V
Positive Reference Input (V _{REF+})		(V _{REF-}) + 0.1		AV _{DD} + 0.1	V
Common-Mode Rejection	at DC		120		dB
Common-Mode Rejection	f _{VREFCM} = 60Hz, f _{DATA} = 60Hz		120		dB
Bias Current ⁽³⁾	V _{REF} = 2.5V, PGA = 1		1.3		μA
ON-CHIP VOLTAGE REFERENCE					
Output Voltage	REF HI = 1	2.4	2.5	2.6	V
	REF HI = 0		1.25		V
Short-Circuit Current Source			8		mA
Short-Circuit Current Sink			50		μA
Drift			15		ppm/°C
Noise	V _{RCAP} = 0.1μF, BW = 0.1Hz to 100Hz		10		μVrms
Output Impedance	Sourcing 100μA		3		Ω
Startup Time			5		ms
IDAC					
Full-Scale Output Current	R _{DAC} = 150kΩ, Range = 1		0.5		mA
	R _{DAC} = 150kΩ, Range = 2		1		mA
	R _{DAC} = 150kΩ, Range = 3		2		mA
	R _{DAC} = 15kΩ, Range = 3		20		mA
Current Setting Resistance (R _{DAC})		10			kΩ
Monotonicity	R _{DAC} = 150kΩ	8			Bits
Compliance Voltage		0		AV _{DD} - 1	V
Output Impedance			See Typical Characteristics		
PSRR	V _{OUT} = AV _{DD} /2, Code > 16		400		ppm/V
Gain Error	Individual IDAC		5		%
Gain Error Drift	Individual IDAC		75		ppm/°C
Gain Error Mismatch	Between IDACs, Same Range and Code		0.25		%
Gain Error Mismatch Drift	Between IDACs, Same Range and Code		15		ppm/°C
POWER-SUPPLY REQUIREMENTS					
Power-Supply Voltage	AV _{DD}	4.75		5.25	V
Analog Current (I _{ADC} + I _{VREF} + I _{IDAC})	PDWN = 0, or SLEEP		1		nA
A/D Converter Current (I _{ADC})	PGA = 1, Buffer OFF		175	275	μA
	PGA = 128, Buffer OFF		500	750	μA
	PGA = 1, Buffer ON		250	350	μA
	PGA = 128, Buffer ON		900	1375	μA
V _{REF} Current (I _{VREF})			250	375	μA
I _{IDAC} Current (I _{IDAC})	Excludes Load Current		480	675	μA
Digital Current	Normal Mode, DV _{DD} = 5V		180	275	μA
	SLEEP Mode, DV _{DD} = 5V		150		μA
	Read Data Continuous Mode, DV _{DD} = 5V		230		μA
	PDWN = 0		1		nA
Power Dissipation	PGA = 1, Buffer OFF, REFEN = 0, IDACs OFF, DV _{DD} = 5V		1.8	2.8	mW

NOTES: (1) FSR is Full-Scale Range. (2) ΔV_{OUT} is change in digital result. (3) 12pF switched capacitor at f_{SAMP} clock frequency.

ELECTRICAL CHARACTERISTICS: AV_{DD} = 3V

All specifications at -40°C to +85°C, AV_{DD} = +3V, DV_{DD} = +2.7V to 5.25V, f_{MOD} = 19.2kHz, PGA = 1, Buffer ON, R_{DAC} = 75kΩ, f_{DATA} = 10Hz, and V_{REF} = +1.25V, unless otherwise specified.

PARAMETER	CONDITIONS	ADS1217			UNITS
		MIN	TYP	MAX	
ANALOG INPUT (A_{IN0} – A_{IN7}, A_{INCOM})					
Full-Scale Input Voltage	(A _{IN+}) – (A _{IN-})		±2V _{REF} /PGA		V
Analog Input Range	Buffer OFF	AGND – 0.1		AV _{DD} + 0.1	V
	Buffer ON	AGND + 0.05		AV _{DD} – 1.5	V
Input Impedance	Buffer OFF		10/PGA		MΩ
Input Current	Buffer ON		0.5		nA
Bandwidth					
Fast Settling Filter	–3dB		0.469f _{DATA}		Hz
Sinc ² Filter	–3dB		0.318f _{DATA}		Hz
Sinc ³ Filter	–3dB		0.262f _{DATA}		Hz
Programmable Gain Amplifier	User Selectable Gain Ranges	1		128	
Burnout Current Sources			2		μA
OFFSET DAC					
Offset DAC Range			±V _{REF} /(PGA)		V
Offset DAC Monotonicity		8			Bits
Offset DAC Gain Error			±1		%
Offset DAC Gain Error Drift			2		ppm/°C
SYSTEM PERFORMANCE					
Resolution	Sinc ³ Filter	24		24	Bits
No Missing Codes	End Point Fit, Differential Input, Buffer Off, T = 25°C		0.0003	0.0012	Bits
Integral Nonlinearity	Before Calibration				% of FSR ⁽¹⁾
Offset Error	After Calibration		15		ppm of FSR
Offset Drift			0.04		ppm of FSR/°C
Gain Error			0.010		%
Gain Error Drift			1.0		ppm/°C
Common-Mode Rejection	at DC	100			dB
	f _{CM} = 60Hz, f _{DATA} = 10Hz		130		dB
	f _{CM} = 50Hz, f _{DATA} = 50Hz		120		dB
	f _{CM} = 60Hz, f _{DATA} = 60Hz		120		dB
Normal-Mode Rejection	f _{SIG} = 50Hz, f _{DATA} = 50Hz		100		dB
	f _{SIG} = 60Hz, f _{DATA} = 60Hz		100		dB
Output Noise			See Typical Characteristics		
Power-Supply Rejection	at DC, dB = –20 log(ΔV _{OUT} /ΔV _{DD}) ⁽²⁾	75	90		dB
VOLTAGE REFERENCE INPUT					
Reference Input (V _{REF})	V _{REF} ≡ (V _{REF+}) – (V _{REF-})	0.1	1.25	1.3	V
Negative Reference Input (V _{REF-})		AGND – 0.1		(V _{REF+}) – 0.1	V
Positive Reference Input (V _{REF+})		(V _{REF-}) + 0.1		AV _{DD} + 0.1	V
Common-Mode Rejection	at DC		120		dB
Common-Mode Rejection	f _{VREFCM} = 60Hz, f _{DATA} = 60Hz		120		dB
Bias Current ⁽³⁾	V _{REF} = 1.25V		0.65		μA
ON-CHIP VOLTAGE REFERENCE					
Output Voltage	REF HI = 0	1.2	1.25	1.3	V
Short-Circuit Current Source			3		mA
Short-Circuit Current Sink			50		μA
Drift			15		ppm/°C
Noise	V _{RCAP} = 0.1μF, BW = 0.1Hz to 100Hz		10		μVrms
Output Impedance	Sourcing 100μA		3		Ω
Startup Time			5		ms
IDAC					
Full-Scale Output Current	R _{DAC} = 75kΩ, Range = 1		0.5		mA
	R _{DAC} = 75kΩ, Range = 2		1		mA
	R _{DAC} = 75kΩ, Range = 3		2		mA
	R _{DAC} = 15kΩ, Range = 3		20		mA
Current Setting Resistance (R _{DAC})		10			kΩ
Monotonicity	R _{DAC} = 75kΩ	8			Bits
Compliance Voltage		0		AV _{DD} – 1	V
Output Impedance			See Typical Characteristics		
PSRR	V _{OUT} = AV _{DD} /2, Code > 16		600		ppm/V
Gain Error	Individual IDAC		5		%
Gain Error Drift	Individual IDAC		75		ppm/°C
Gain Error Mismatch	Between IDACs, Same Range and Code		0.25		%
Gain Error Mismatch Drift	Between IDACs, Same Range and Code		15		ppm/°C

NOTES: (1) FSR is Full-Scale Range. (2) ΔV_{OUT} is change in digital result. (3) 12pF switched capacitor at f_{SAMP} clock frequency.

ELECTRICAL CHARACTERISTICS: $AV_{DD} = 3V$ (Cont.)

All specifications at -40°C to $+85^{\circ}\text{C}$, $AV_{DD} = +3V$, $DV_{DD} = +2.7V$ to $5.25V$, $f_{MOD} = 19.2\text{kHz}$, $\text{PGA} = 1$, Buffer ON, $R_{DAC} = 75\text{k}\Omega$, $f_{DATA} = 10\text{Hz}$, and $V_{REF} = +1.25V$, unless otherwise specified.

PARAMETER	CONDITIONS	ADS1217			UNITS
		MIN	TYP	MAX	
POWER-SUPPLY REQUIREMENTS					
Power-Supply Voltage	AV_{DD}	2.7		3.3	V
Analog Current ($I_{ADC} + I_{VREF} + I_{DAC}$)	$\overline{\text{PDWN}} = 0$, or SLEEP PGA = 1, Buffer OFF		1		nA
A/D Converter Current (I_{ADC})	PGA = 128, Buffer OFF PGA = 1, Buffer ON PGA = 128, Buffer ON		160 450 230 850	250 700 325 1325	μA μA μA μA
V_{REF} Current (I_{VREF})			250	375	μA
I_{DAC} Current (I_{DAC})	Excludes Load Current		480	675	μA
Digital Current	Normal Mode, $DV_{DD} = 3V$ SLEEP Mode, $DV_{DD} = 3V$ Read Data Continuous Mode, $DV_{DD} = 3V$ PDWN = 0		90 75 113 1	200	μA μA μA nA
Power Dissipation	PGA = 1, Buffer OFF, REFEN = 0, IDACs OFF, $DV_{DD} = 3V$		0.8	1.4	mW

NOTES: (1) FSR is Full-Scale Range. (2) ΔV_{OUT} is change in digital result. (3) 12pF switched capacitor at f_{SAMP} clock frequency.

ELECTRICAL CHARACTERISTICS: Digital

All specifications at -40°C to $+85^{\circ}\text{C}$, and $DV_{DD} = +2.7V$ to $5.25V$.

PARAMETER	CONDITIONS	MIN	TYP	MAX	UNITS
INPUT/OUTPUT					
Logic Level					
V_{IH}		$0.8 \times DV_{DD}$		DV_{DD}	V
$V_{IL}^{(1)}$		DGND		$0.2 \times DV_{DD}$	V
V_{OH}	$I_{OH} = 1\text{mA}$	$DV_{DD} - 0.4$			V
V_{OL}	$I_{OL} = 1\text{mA}$	DGND		$DGND + 0.4$	V
Input Leakage: I_{IN}	$0 < V_I < DV_{DD}$	-10		10	μA
CLOCK RATES					
Master Clock Rate: f_{OSC}		1		8	MHz
Master Clock Period: t_{OSC}	$1/f_{OSC}$	125		1000	ns

NOTE: (1) Maximum V_{IL} for X_{IN} is DGND + 0.05V.

PIN CONFIGURATION

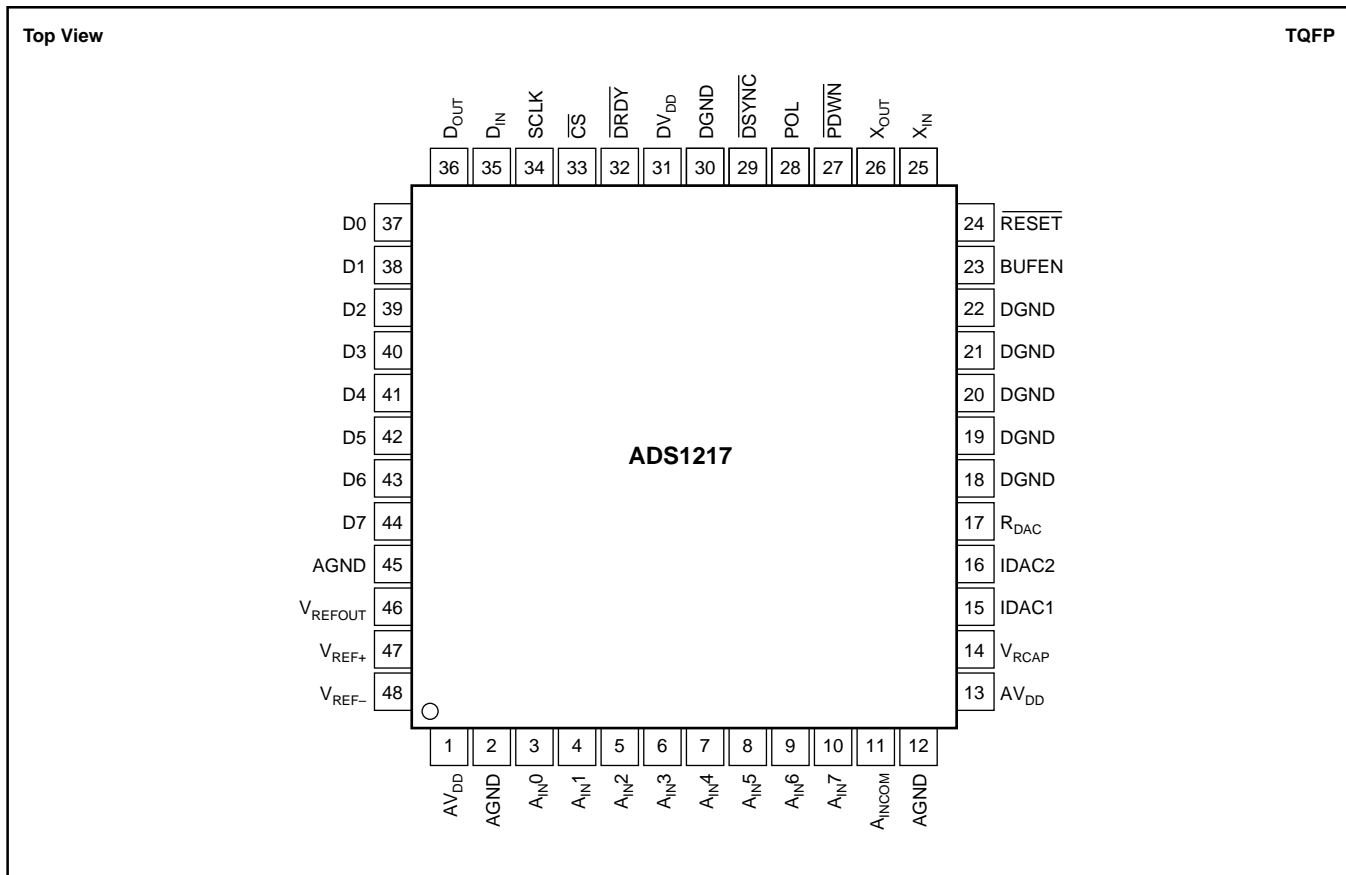

PIN DESCRIPTIONS

PIN NUMBER	NAME	DESCRIPTION	PIN NUMBER	NAME	DESCRIPTION
1	AV _{DD}	Analog Power Supply	25	X _{IN}	Clock Input
2	AGND	Analog Ground	26	X _{OUT}	Clock Output, used with crystal or resonator.
3	A _{IN0}	Analog Input 0	27	PDWN	Active LOW. Power Down. The power-down function shuts down the analog and digital circuits.
4	A _{IN1}	Analog Input 1			
5	A _{IN2}	Analog Input 2	28	POL	Serial Clock Polarity Input
6	A _{IN3}	Analog Input 3	29	DSYNC	Active LOW, Synchronization Control Input
7	A _{IN4}	Analog Input 4	30	DGND	Digital Ground
8	A _{IN5}	Analog Input 5	31	DV _{DD}	Digital Power Supply
9	A _{IN6}	Analog Input 6	32	DRDY	Active LOW, Data Ready Output
10	A _{IN7}	Analog Input 7	33	CS	Active LOW, Chip Select Input
11	A _{INCOM}	Analog Input Common	34	SCLK	Serial Clock, Schmitt Trigger
12	AGND	Analog Ground	35	D _{IN}	Serial Data Input, Schmitt Trigger
13	AV _{DD}	Analog Power Supply	36	D _{OUT}	Serial Data Output
14	V _{RCAP}	V _{REFOUT} Bypass Capacitor	37-44	D0-D7	Digital I/O 0-7
15	IDAC1	Current DAC1 Output	45	AGND	Analog Ground
16	IDAC2	Current DAC2 Output	46	V _{REFOUT}	Voltage Reference Output
17	R _{DAC}	Current DAC Resistor	47	V _{REF+}	Positive Differential Reference Input
18-22	DGND	Digital Ground	48	V _{REF-}	Negative Differential Reference Input
23	BUFEN	Buffer Enable Input			
24	RESET	Active LOW, resets the entire chip.			

TIMING DIAGRAMS

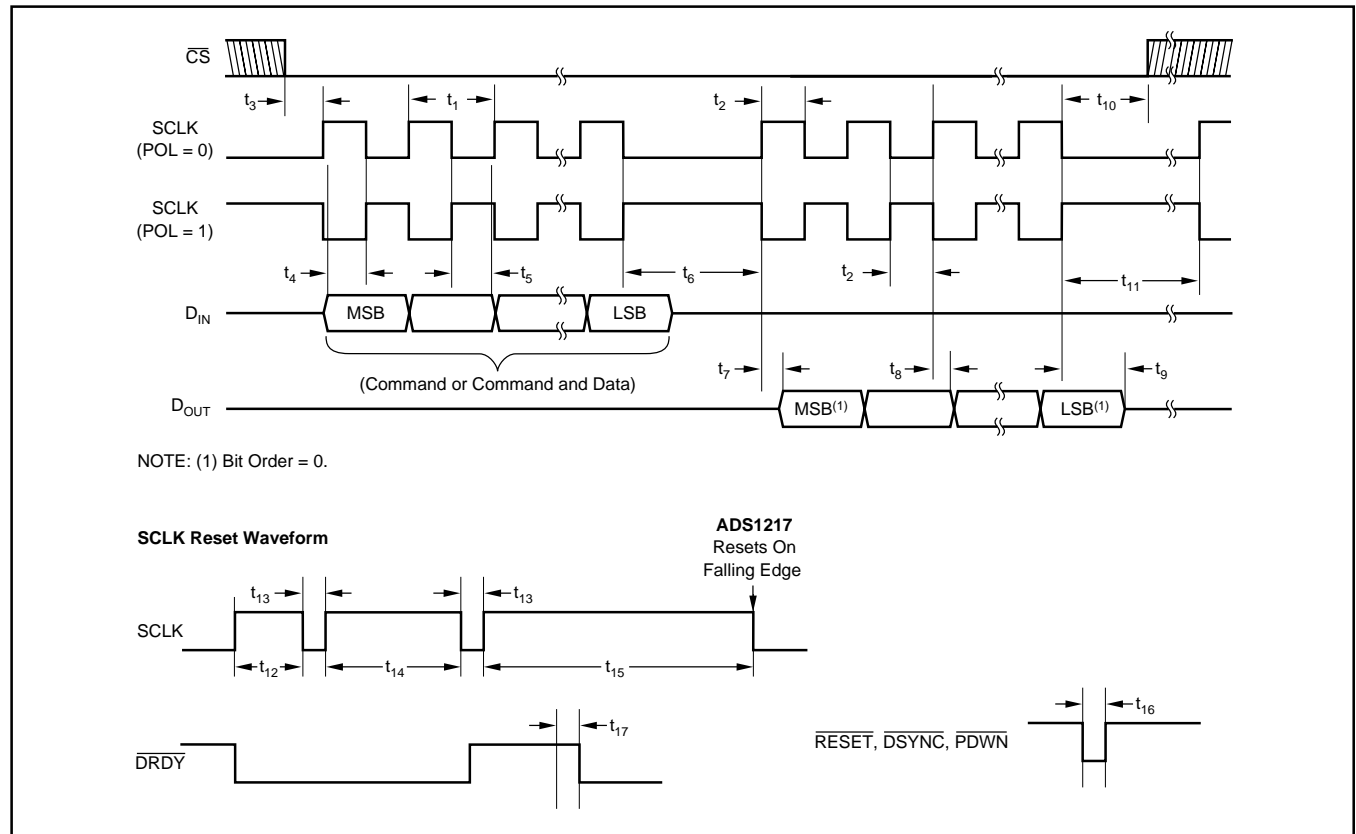

TIMING CHARACTERISTICS

SPEC	DESCRIPTION	MIN	MAX	UNITS
t_1	SCLK Period	4	3	t_{osc} Periods DRDY Periods
t_2	SCLK Pulse Width, HIGH and LOW	200		ns
t_3	\overline{CS} LOW to First SCLK Edge; Setup Time ⁽¹⁾	0		ns
t_4	D_{IN} Valid to SCLK Edge; Setup Time	50		ns
t_5	Valid D_{IN} to SCLK Edge; Hold Time	50		ns
t_6	Delay Between Last SCLK Edge for D_{IN} and First SCLK Edge for D_{OUT} :			
	RDATA, RDATA, RREG, WREG, RRAM, WRAM	50		t_{osc} Periods
	CSREG, CSRAMX, CSRAM	200		t_{osc} Periods
	CSARAM, CSARAMX	1100		t_{osc} Periods
$t_7^{(2)}$	SCLK Edge to Valid New D_{OUT}		50	ns
$t_8^{(2)}$	SCLK Edge to D_{OUT} , Hold Time	0		ns
t_9	Last SCLK Edge to D_{OUT} Tri-State NOTE: D_{OUT} goes tri-state immediately when \overline{CS} goes HIGH.	6	10	t_{osc} Periods
t_{10}	\overline{CS} LOW Time After Final SCLK Edge	0		ns
t_{11}	Final SCLK Edge of One Op Code Until First Edge SCLK of Next Command:			t_{osc} Periods
	RREG, WREG, RRAM, WRAM, CSRAMX, CSARAMX, CSRAM, CSARAM, CSREG, DSYNC, SLEEP, RDATA, RDATA, STOPC	4		t_{osc} Periods
	CREG, CRAM	220		t_{osc} Periods
	CREGA	1600		t_{osc} Periods
	SELFGCAL, SELFOCAL, SYSOCAL, SYSGCAL	7		t_{osc} Periods
	SELFCAL	14		DRDY Periods
	RESET (Input pin, command, or SCLK pattern)	16		t_{osc} Periods
t_{12}		300	500	t_{osc} Periods
t_{13}		5		t_{osc} Periods
t_{14}		550		t_{osc} Periods
t_{15}		1050	1250	t_{osc} Periods
t_{16}	Pulse Width	4		t_{osc} Periods
t_{17}	Data Not Valid	4		t_{osc} Periods

NOTES: (1) \overline{CS} may be tied LOW. (2) Load = 20pF.

TYPICAL CHARACTERISTICS

$A_{V_{DD}} = +5V$, $DV_{DD} = +5V$, $f_{OSC} = 2.4576MHz$, $PGA = 1$, $R_{DAC} = 150k\Omega$, $f_{DATA} = 10Hz$, and $V_{REF} = +2.5V$, unless otherwise specified.

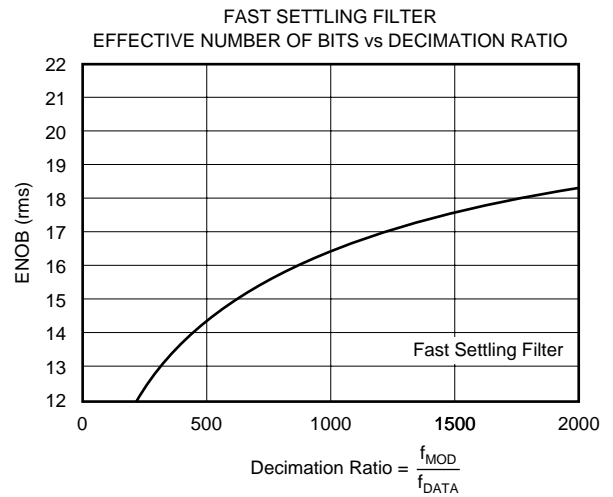
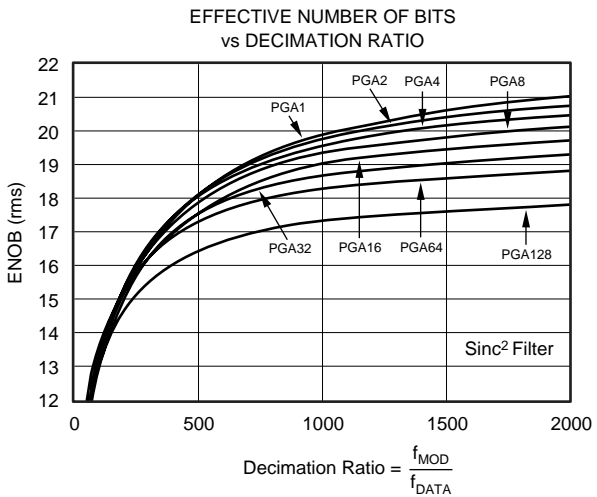
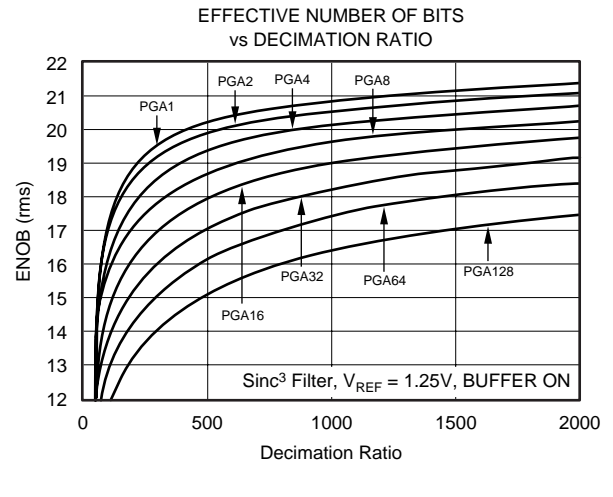
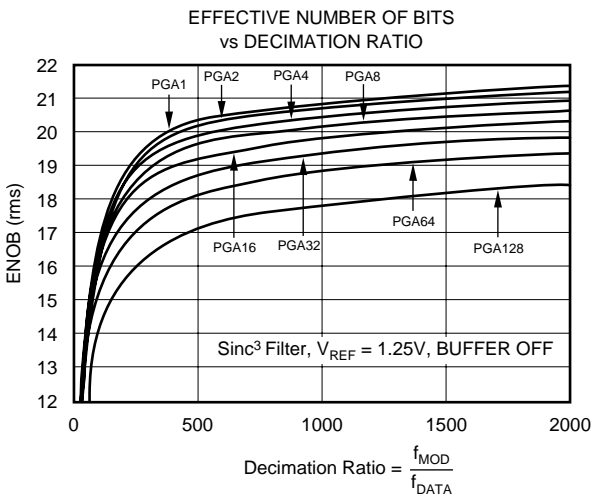
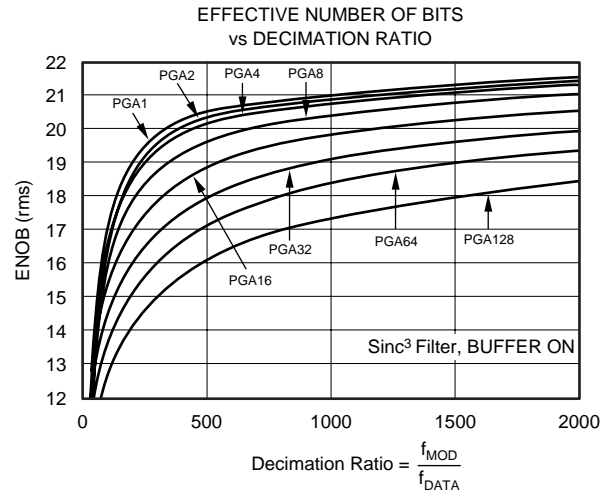
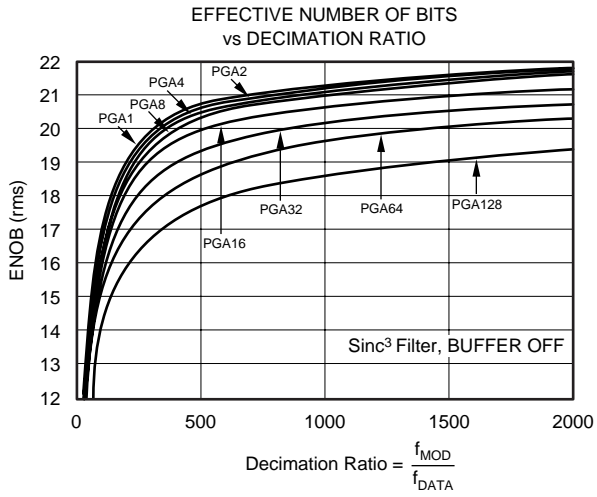

TYPICAL CHARACTERISTICS (Cont.)

$AV_{DD} = +5V$, $DV_{DD} = +5V$, $f_{OSC} = 2.4576MHz$, $PGA = 1$, $R_{DAC} = 150k\Omega$, $f_{DATA} = 10Hz$, and $V_{REF} = +2.5V$, unless otherwise specified.

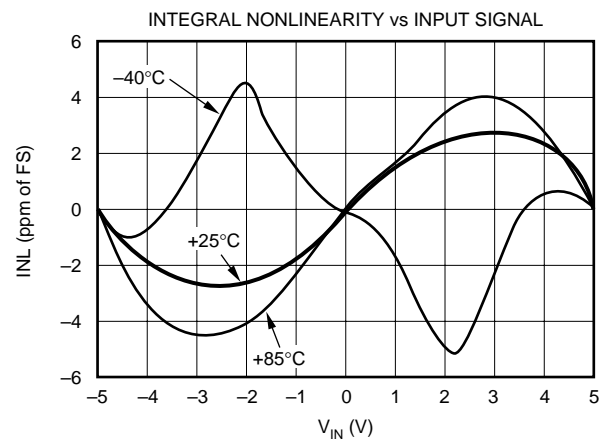
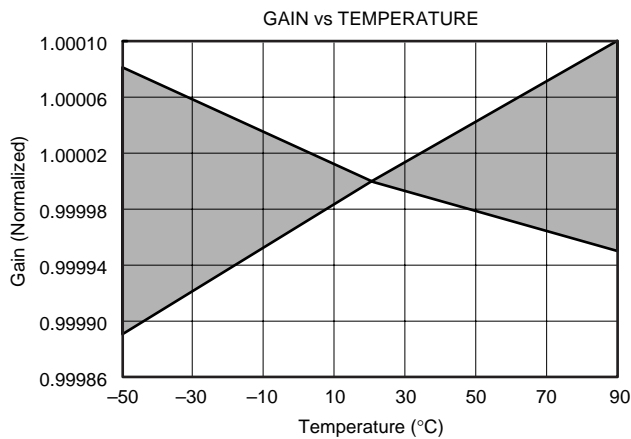
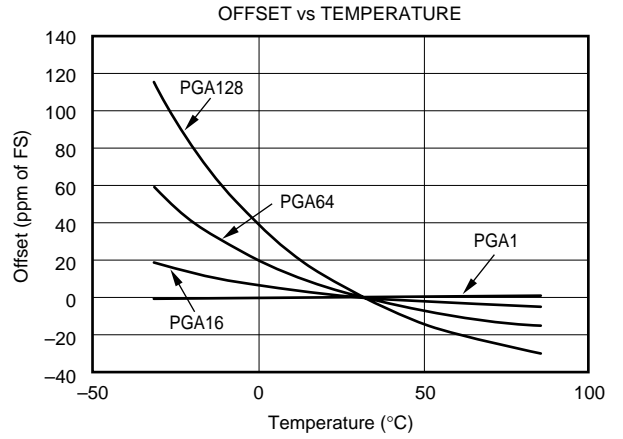
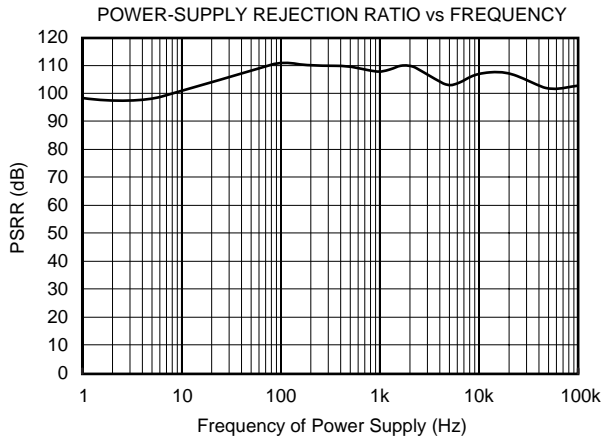
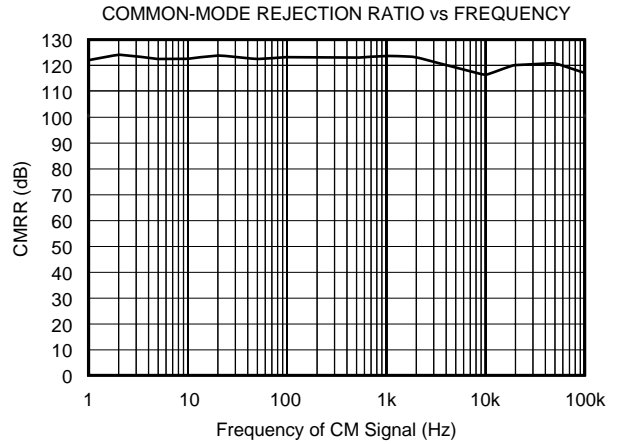
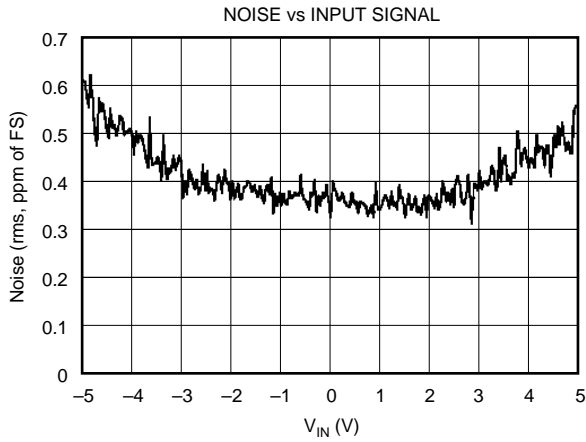

TYPICAL CHARACTERISTICS (Cont.)

$AV_{DD} = +5V$, $DV_{DD} = +5V$, $f_{OSC} = 2.4576MHz$, $PGA = 1$, $R_{DAC} = 150k\Omega$, $f_{DATA} = 10Hz$, and $V_{REF} = +2.5V$, unless otherwise specified.

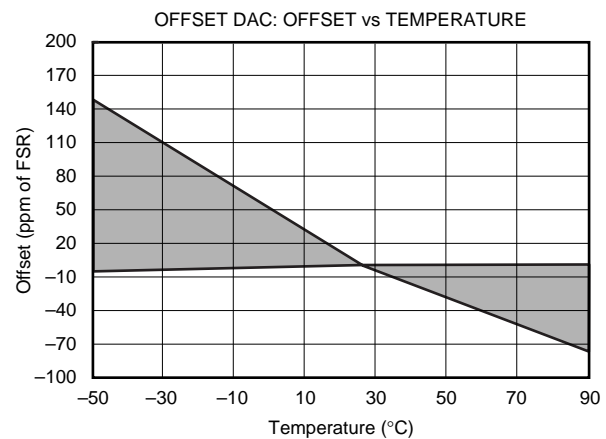
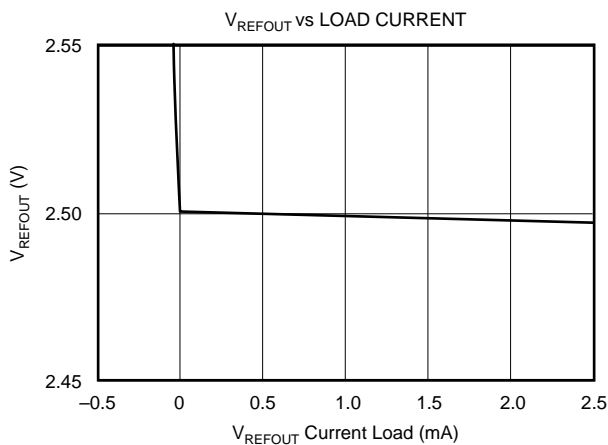
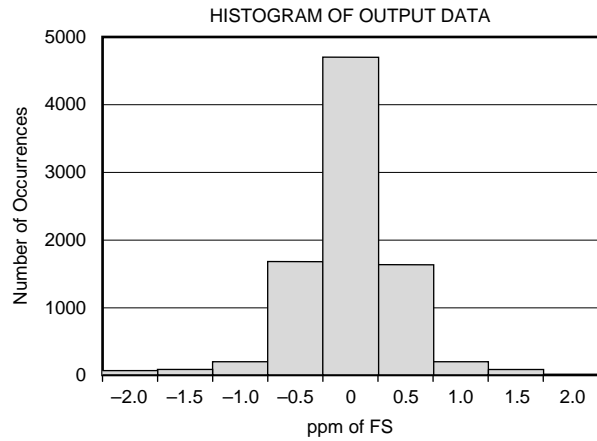
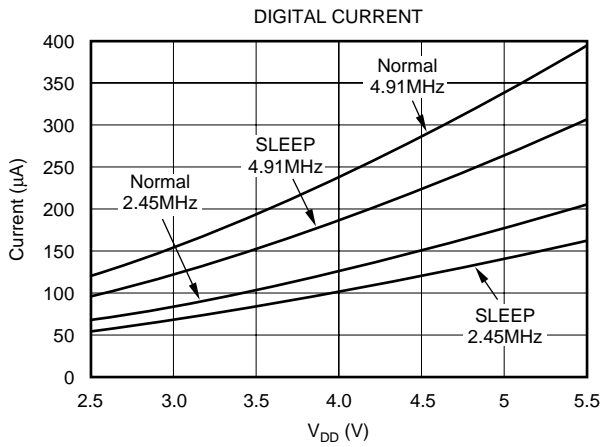
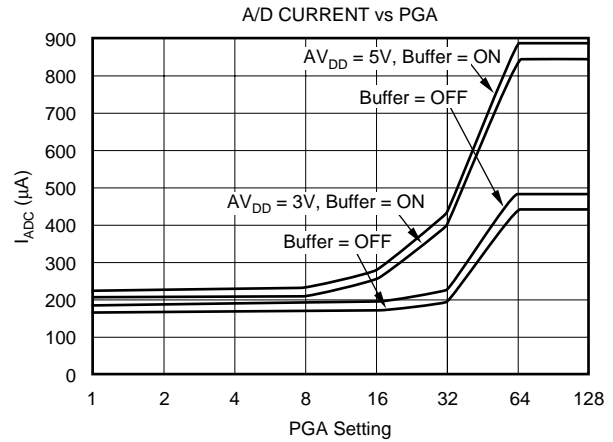
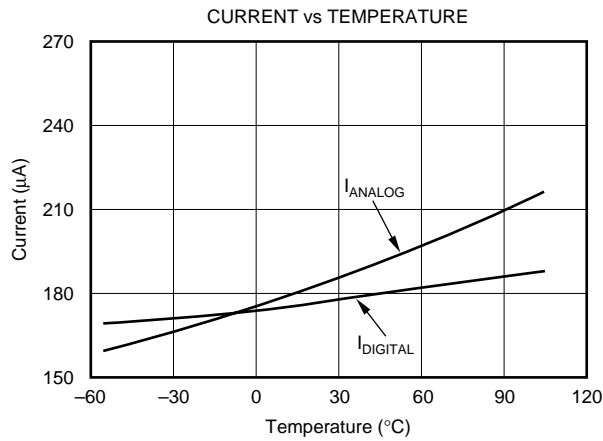

TYPICAL CHARACTERISTICS (Cont.)

$V_{DD} = +5V$, $DV_{DD} = +5V$, $f_{OSC} = 2.4576MHz$, $PGA = 1$, $R_{DAC} = 150k\Omega$, $f_{DATA} = 10Hz$, and $V_{REF} = +2.5V$, unless otherwise specified.

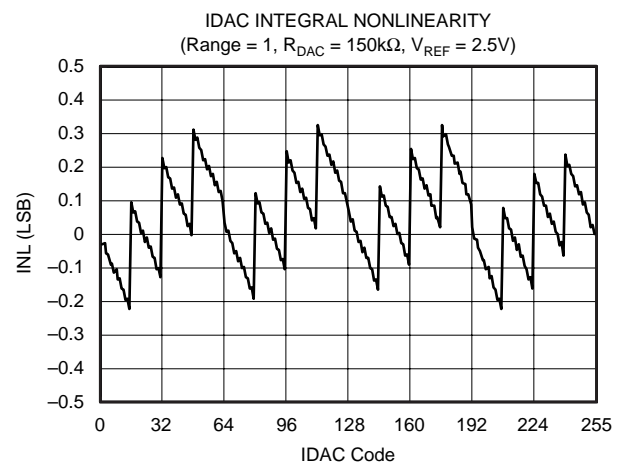
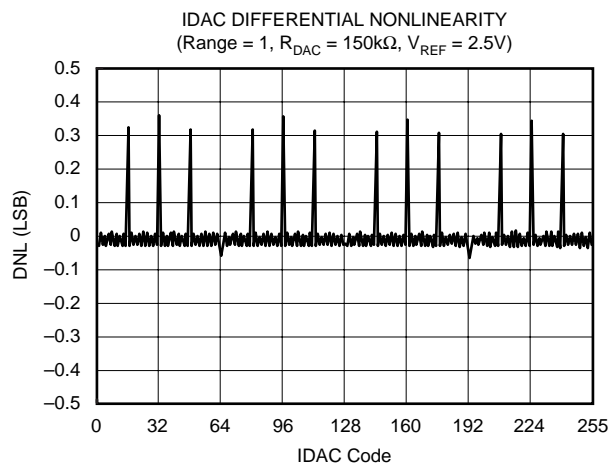
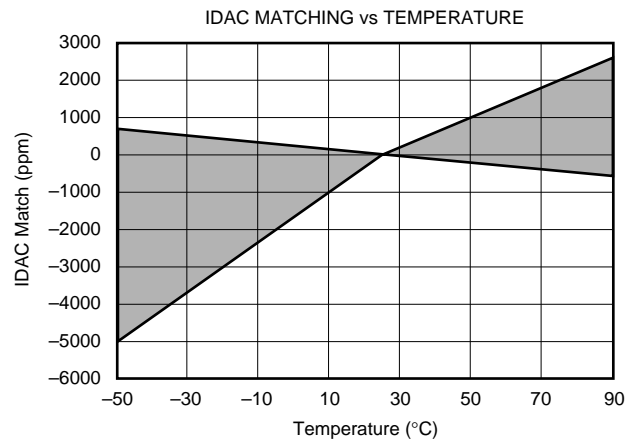
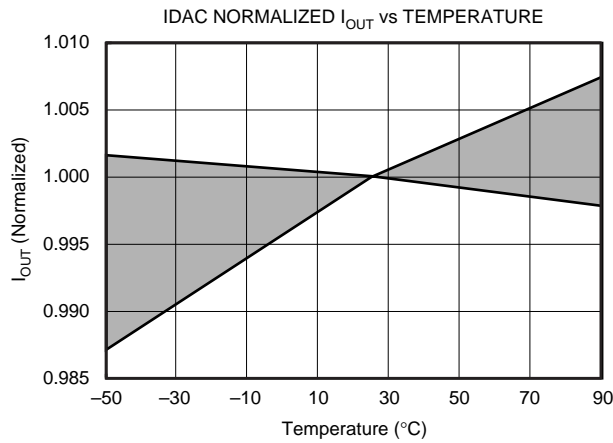
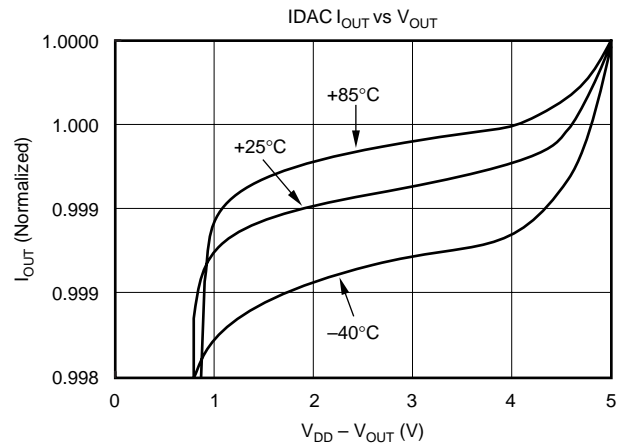
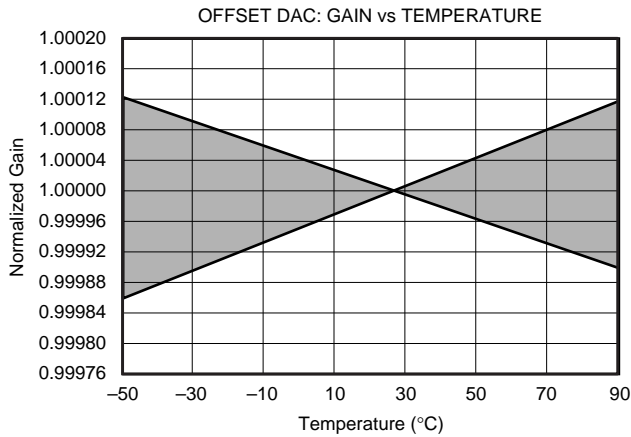

OVERVIEW

INPUT MULTIPLEXER

The input multiplexer (mux) provides for any combination of differential inputs to be selected on any of the input channels, as shown in Figure 1. If channel 1 is selected as the positive differential input channel, any other channel can be selected as the negative differential input channel. With this method, it is possible to have up to eight fully differential input channels.

In addition, current sources are supplied that will source or sink current to detect open or short circuits on the pins.

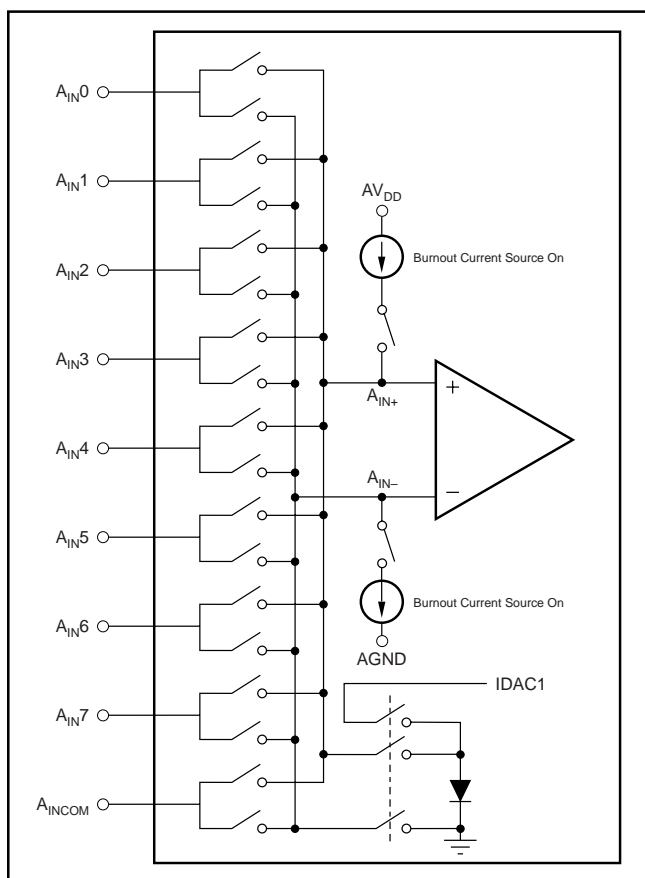

FIGURE 1. Input Multiplexer Configuration.

TEMPERATURE SENSOR

An on-chip diode provides temperature sensing capability. When the configuration register for the input MUX is set to all 1s, the diode is connected to the input of the A/D converter. All other channels are open. The anode of the diode is connected to the positive input of the A/D converter, and the cathode of the diode is connected to negative input of the A/D converter. The output of IDAC1 is connected to the anode to bias the diode and the cathode of the diode is also connected to ground to complete the circuit.

In this mode, the output of IDAC1 is also connected to the output pin, so some current may flow into an external load from IDAC1, rather than the diode. See Application Report *Measuring Temperature with the ADS1216, ADS1217, or ADS1218* (SBAA073) for more information.

BURNOUT CURRENT SOURCES

When the Burnout bit is set in the ACR configuration register, two current sources are enabled. The current source on the positive input channel sources approximately $2\mu\text{A}$ of current. The current source on the negative input channel sinks approximately $2\mu\text{A}$. This allows for the detection of an open circuit (full-scale reading) or short circuit (0V differential reading) on the selected input differential pair.

INPUT BUFFER

The input impedance of the ADS1217 without the buffer is $10\text{M}\Omega/\text{PGA}$. With the buffer enabled, the input voltage range is reduced and the analog power-supply current is higher. The buffer is controlled by ANDing the state of the buffer pin with the state of the BUFFER bit in the ACR register. See Application Report *Input Currents for High-Resolution ADCs* (SBAA090) for more information.

IDAC1 AND IDAC2

The ADS1217 has two 8-bit current output DACs that can be controlled independently. The output current is set with R_{DAC} , the range select bits in the ACR register, and the 8-bit digital value in the IDAC register. The output current = $(V_{\text{REF}}/8R_{\text{DAC}}) (2^{\text{RANGE}-1}) (\text{DAC CODE})$. With $V_{\text{REFOUT}} = 2.5\text{V}$ and $R_{\text{DAC}} = 150\text{k}\Omega$, the full-scale output can be selected to be 0.5, 1, or 2mA. The compliance voltage range is AGND to within 1V of AV_{DD} . When the internal voltage reference of the ADS1217 is used, it is the reference for the IDAC. An external reference may be used for the IDACs by disabling the internal reference and tying the external reference input to the V_{REFOUT} pin.

PGA

The PGA can be set to gains of 1, 2, 4, 8, 16, 32, 64, or 128. Using the PGA can improve the effective resolution of the A/D converter. For instance, with a PGA of 1 on a 10V full-scale range, the A/D converter can resolve to $2\mu\text{V}$. With a PGA of 128 on a 80mV full-scale range, the A/D converter can resolve to 150nV.

PGA OFFSET DAC

The input to the PGA can be shifted by half the full-scale input range of the PGA by using the ODAC register. The ODAC (Offset DAC) register is an 8-bit value; the MSB is the sign and the seven LSBs provide the magnitude of the offset. Using the ODAC does not reduce the performance of the A/D converter. See Application Report *The Offset DAC* (SBAA077) for more information.

MODULATOR

The modulator is a single-loop, 2nd-order system. The modulator runs at a clock speed (f_{MOD}) that is derived from the external clock (f_{OSC}). The frequency division is determined by the SPEED bit in the setup register.

SPEED BIT	f_{MOD}
0	$f_{\text{OSC}}/128$
1	$f_{\text{OSC}}/256$

VOLTAGE REFERENCE INPUT

The ADS1217 uses a differential voltage reference input. The input signal is measured against the differential voltage $V_{REF} \equiv (V_{REF+}) - (V_{REF-})$. For $AV_{DD} = 5V$, V_{REF} is typically 2.5V. For $AV_{DD} = 3V$, V_{REF} is typically 1.25V. Due to the sampling nature of the modulator, the reference input current increases with higher modulator clock frequency (f_{MOD}) and higher PGA settings.

ON-CHIP VOLTAGE REFERENCE

A selectable voltage reference (1.25V or 2.5V) is available for supplying the voltage reference input. To use, connect V_{REF-} to AGND and V_{REF+} to V_{REFOUT} . The enabling and voltage selection are controlled through bits REF EN and REF HI in the setup register. The 2.5V reference requires $AV_{DD} = 5V$. When using the on-chip voltage reference, the V_{REFOUT} pin should be bypassed with a 0.1 μ F capacitor to AGND.

V_{RCAP} PIN

This pin provides a bypass cap for noise filtering on internal V_{REF} circuitry only. As this is a sensitive pin, place the capacitor as close as possible and avoid any resistive loading. The recommended capacitor is a 0.001 μ F ceramic cap. If an external V_{REF} is used, this pin can be left unconnected.

CLOCK GENERATOR

The clock source for the ADS1217 can be provided from a crystal, oscillator, or external clock. When the clock source is a crystal, external capacitors must be provided to ensure start-up and a stable clock frequency; see Figure 2 and Table I.

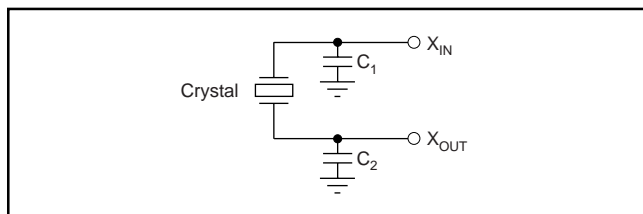

FIGURE 2. Crystal Connection.

CLOCK SOURCE	FREQUENCY	C ₁	C ₂	PART NUMBER
Crystal	2.4576	0-20pF	0-20pF	ECS, ECSD 2.45 - 32
Crystal	4.9152	0-20pF	0-20pF	ECS, ECSL 4.91
Crystal	4.9152	0-20pF	0-20pF	ECS, ECSD 4.91
Crystal	4.9152	0-20pF	0-20pF	CTS, MP 042 4M9182

TABLE I. Typical Clock Sources.

CALIBRATION

The offset and gain errors in the ADS1217, or the complete system, can be reduced with calibration. Internal calibration of the ADS1217 is called self calibration. This is handled with three commands. One command does both offset and gain calibration. There is also a gain calibration command and an offset calibration command. Each calibration process takes seven t_{DATA} periods to complete. It takes 14 t_{DATA} periods to

complete both an offset and gain calibration. Self-gain calibration is optimized for PGA gains less than 8. When using higher gains, system gain calibration is recommended.

For system calibration, the appropriate signal must be applied to the inputs. The system offset command requires a “zero” differential input signal. It then computes an offset that will nullify offset in the system. The system gain command requires a positive “full-scale” differential input signal. It then computes a value to nullify gain errors in the system. Each of these calibrations will take seven t_{DATA} periods to complete.

Calibration must be performed after power on, a change in decimation ratio, or a change of the PGA. For operation with a reference voltage greater than $(AV_{DD} - 1.5V)$, the buffer must also be turned off during calibration.

At the completion of calibration, the \overline{DRDY} signal goes LOW, which indicates the calibration is finished and valid data is available. See Application Report *Calibration Routine and Register Value Generation for the ADS121x Series* (SBAA099) for more information.

DIGITAL FILTER

The Digital Filter can use either the fast settling, sinc², or sinc³ filter, as shown in Figure 3. In addition, the Auto mode changes the sinc filter after the input channel or PGA is changed. When switching to a new channel, it will use the fast settling filter; It will then use the sinc² followed by the sinc³ filter. This combines the low-noise advantage of the sinc³ filter with the quick response of the fast settling time filter. See Figure 4 for the frequency response of each filter.

When using the fast setting filter, select a decimation value set by the DEC0 and M/DEC1 registers that is evenly divisible by four for the best gain accuracy. For example, choose 260 rather than 261.

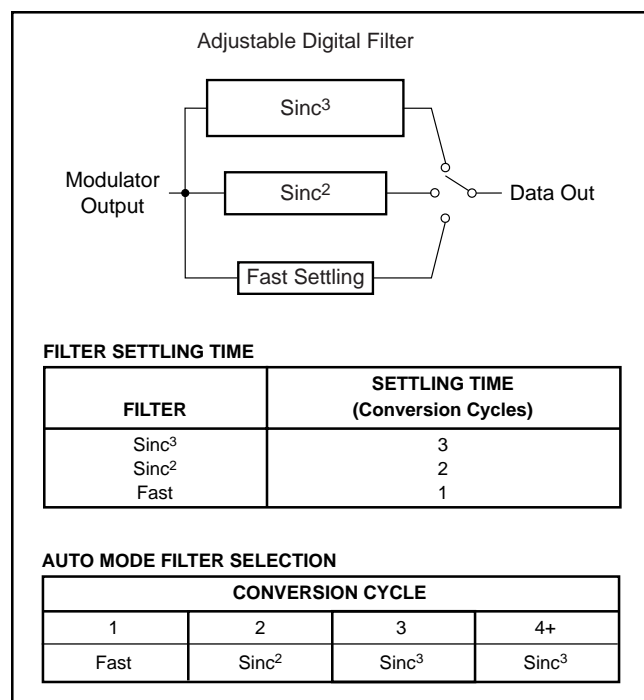

FIGURE 3. Filter Step Responses.

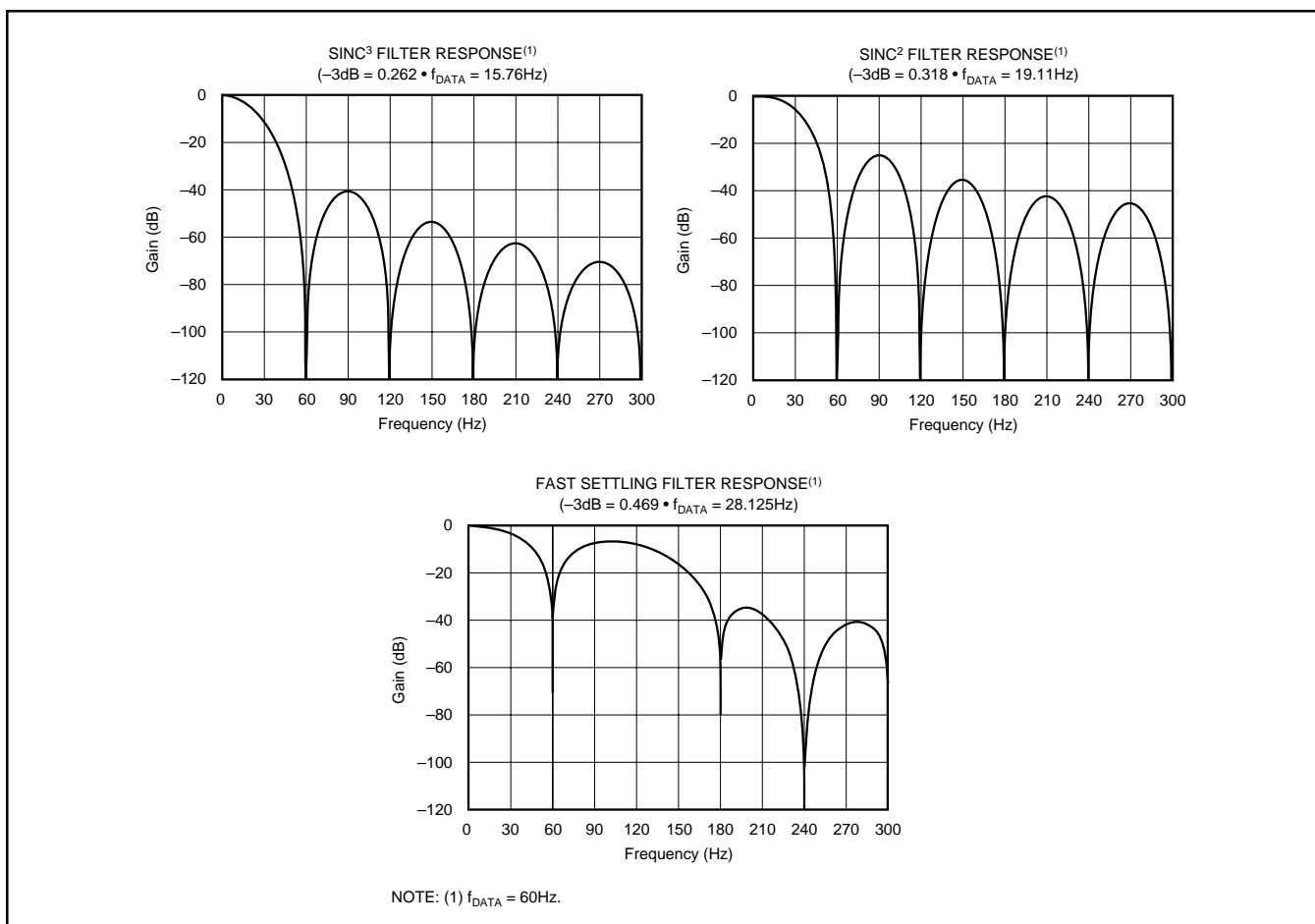

FIGURE 4. Filter Frequency Responses.

DIGITAL I/O INTERFACE

The ADS1217 has eight pins dedicated for digital I/O. The default power-up condition for the digital I/O pins are as inputs. All of the digital I/O pins are individually configurable as inputs or outputs. They are configured through the DIR control register. The DIR register defines whether the pin is an input or output, and the DIO register defines the state of the digital output. When the digital I/O are configured as inputs, DIO is used to read the state of the pin. If the digital I/O are not used, either 1) configure as outputs; or, 2) leave as inputs and tie to ground, this prevents excess power dissipation.

SERIAL PERIPHERAL INTERFACE

The Serial Peripheral Interface (SPI) allows a controller to communicate synchronously with the ADS1217. The ADS1217 operates in slave only mode.

Chip Select (\overline{CS})

The chip select (\overline{CS}) input of the ADS1217 must be externally asserted before a master device can exchange data with the ADS1217. \overline{CS} must be LOW for the duration of the transaction. \overline{CS} can be tied low.

Serial Clock (SCLK)

SCLK, a Schmitt Trigger input, clocks data transfer on the D_{IN} input and D_{OUT} output. When transferring data to or from the ADS1217, multiple bits of data may be transferred back-to-

back with no delay in SCLKs or toggling of \overline{CS} . Make sure to avoid glitches on SCLK as they can cause extra shifting of the data.

Polarity (POL)

The serial clock polarity is specified by the POL input. When SCLK is active HIGH, set POL HIGH. When SCLK is active LOW, set POL LOW.

DATA READY

The \overline{DRDY} output is used as a status signal to indicate when data is ready to be read from the ADS1217. \overline{DRDY} goes LOW when new data is available. It is reset HIGH when a read operation from the data register is complete. It also goes HIGH prior to the updating of the output register to indicate when not to read from the device to ensure that a data read is not attempted while the register is being updated.

DSYNC OPERATION

DSYNC is used to provide for synchronization of the A/D conversion with an external event. Synchronization can be achieved either through the \overline{DSYNC} pin or the DSYNC command. When the \overline{DSYNC} pin is used, the filter counter is reset on the falling edge of \overline{DSYNC} . The modulator is held in reset until \overline{DSYNC} is taken HIGH. Synchronization occurs on the next rising edge of the system clock after \overline{DSYNC} is taken HIGH.

When the DSYNC command is sent, the filter counter is reset on the edge of the last SCLK on the DSYNC command. The modulator is held in reset until the next edge of SCLK is detected. Synchronization occurs on the next rising edge of the system clock after the first SCLK after the DSYNC command. After a DSYNC operation, $\overline{\text{DRDY}}$ is held HIGH until valid data is ready.

RESET

There are three methods to reset the ADS1217: the $\overline{\text{RESET}}$ input, the RESET command, and a special SCLK input pattern. When using the $\overline{\text{RESET}}$ input, take it LOW to force a reset. Make sure to follow the minimum pulse width timing specifications before taking the $\overline{\text{RESET}}$ input back high. Also, avoid glitches on the $\overline{\text{RESET}}$ input as these may cause accidental resets. The RESET command takes effect after all 8 bits have been shifted into DIN. Afterwards, the reset releases automatically. The ADS1217 can also be reset with a special pattern on SCLK, see the Timing Diagram. Reset occurs on the falling edge of the last SCLK edge in the pattern (for POL = 0). Afterwards, the reset releases automatically.

POWER-UP—SUPPLY VOLTAGE RAMP RATE

The power-on reset circuitry was designed to accommodate digital supply ramp rates as slow as 1V/10ms. To ensure proper operation, the power supply should ramp monotonically.

MEMORY

Two types of memory are used on the ADS1217: registers and RAM. 16 registers directly control the various functions (PGA, DAC value, Decimation Ratio, etc.) and can be directly read or written. Collectively, the registers contain all the information needed to configure the part, such as data format, mux settings, calibration settings, decimation ratio, etc. Additional registers, such as output data, are accessed through dedicated instructions.

REGISTER BANK TOPOLOGY

The operation of the device is set up through individual registers. The set of the 16 registers required to configure the device is referred to as a Register Bank, as shown in Figure 5.

Reads and Writes to Registers and RAM occur on a byte basis. However, copies between registers and RAM occurs on a bank basis. The RAM is independent of the Registers; that is, the RAM can be used as general-purpose RAM.

The ADS1217 supports any combination of eight analog inputs. With this flexibility, the device could easily support eight unique configurations—one per input channel. In order to facilitate this type of usage, eight separate register banks are available. Therefore, each configuration could be written once and recalled as needed without having to serially retransmit all the configuration data. Checksum commands are also included, which can be used to verify the integrity of RAM.

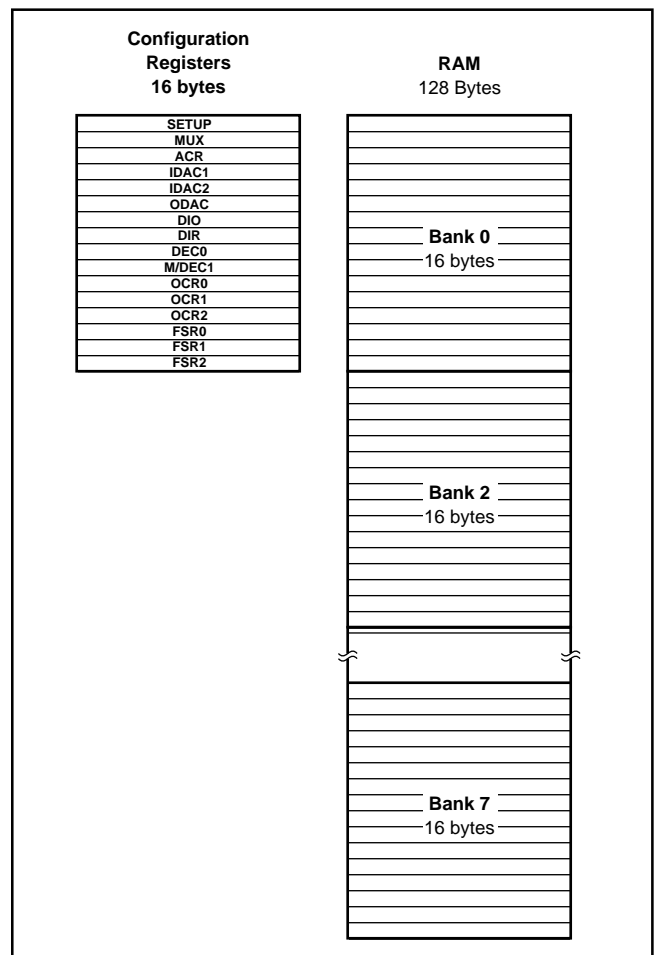

FIGURE 5. Memory Organization.

The RAM provides eight “banks”, with a bank consisting of 16 bytes. The total size of the RAM is 128 bytes. Copies between the registers and RAM are performed on a bank basis. Also, the RAM can be directly read or written through the serial interface on power-up. The banks allow separate storage of settings for each input.

The RAM address space is linear, therefore accessing RAM is done using an auto-incrementing pointer. Access to RAM in the entire memory map can be done consecutively without having to address each bank individually. For example, if you were currently accessing bank 0 at offset $0F_H$ (the last location of bank 0), the next access would be bank 1 and offset 00_H . Any access after bank 7 and offset $0F_H$ will wrap around to bank 0 and Offset 00_H .

Although the Register Bank memory is linear, the concept of addressing the device can also be thought of in terms of bank and offset addressing. Looking at linear and bank addressing syntax, we have the following comparison: in the linear memory map, the address 14_H is equivalent to bank 1 and offset 04_H . Simply stated, the most significant four bits represent the bank, and the least significant four bits represent the offset. The offset is equivalent to the register address for that bank of memory.

REGISTER MAP

ADDRESS	REGISTER	BIT 7	BIT 6	BIT 5	BIT 4	BIT 3	BIT 2	BIT 1	BIT 0
00 _H	SETUP	ID	ID	ID	SPEED	REF EN	REF HI	BUF EN	BIT ORDER
01 _H	MUX	PSEL3	PSEL2	PSEL1	PSEL0	NSEL3	NSEL2	NSEL1	NSEL0
02 _H	ACR	BOCS	IDAC2R1	IDAC2R0	IDAC1R1	IDAC1R0	PGA2	PGA1	PGA0
03 _H	IDAC1	IDAC1_7	IDAC1_6	IDAC1_5	IDAC1_4	IDAC1_3	IDAC1_2	IDAC1_1	IDAC1_0
04 _H	IDAC2	IDAC2_7	IDAC2_6	IDAC2_5	IDAC2_4	IDAC2_3	IDAC2_2	IDAC2_1	IDAC2_0
05 _H	ODAC	SIGN	OSET_6	OSET_5	OSET_4	OSET_3	OSET_2	OSET_1	OSET_0
06 _H	DIO	DIO_7	DIO_6	DIO_5	DIO_4	DIO_3	DIO_2	DIO_1	DIO_0
07 _H	DIR	DIR_7	DIR_6	DIR_5	DIR_4	DIR_3	DIR_2	DIR_1	DIR_0
08 _H	DEC0	DEC07	DEC06	DEC05	DEC04	DEC03	DEC02	DEC01	DEC00
09 _H	M/DEC1	DRDY	U/B	SMODE1	SMODE0	Reserved	DEC10	DEC09	DEC08
0A _H	OCR0	OCR07	OCR06	OCR05	OCR04	OCR03	OCR02	OCR01	OCR00
0B _H	OCR1	OCR15	OCR14	OCR13	OCR12	OCR11	OCR10	OCR09	OCR08
0C _H	OCR2	OCR23	OCR22	OCR21	OCR20	OCR19	OCR18	OCR17	OCR16
0D _H	FSR0	FSR07	FSR06	FSR05	FSR04	FSR03	FSR02	FSR01	FSR00
0E _H	FSR1	FSR15	FSR14	FSR13	FSR12	FSR11	FSR10	FSR09	FSR08
0F _H	FSR2	FSR23	FSR22	FSR21	FSR20	FSR19	FSR18	FSR17	FSR16

TABLE II. Registers.

DETAILED REGISTER DEFINITIONS

SETUP (Address 00_H) Setup Register

Reset Value = iii01110

bit 7	bit 6	bit 5	bit 4	bit 3	bit 2	bit 1	bit 0
ID	ID	ID	SPEED	REF EN	REF HI	BUF EN	BIT ORDER

bit 7-5 Factory Programmed Bits

bit 4 SPEED: Modulator Clock Speed

0 : $f_{MOD} = f_{OSC}/128$ (default)

1 : $f_{MOD} = f_{OSC}/256$

bit 3 REF EN: Internal Voltage Reference Enable

0 = Internal Voltage Reference Disabled

1 = Internal Voltage Reference Enabled (default)

bit 2 REF HI: Internal Reference Voltage Select

0 = Internal Reference Voltage = 1.25V

1 = Internal Reference Voltage = 2.5V (default)

bit 1 BUF EN: Buffer Enable

0 = Buffer Disabled

1 = Buffer Enabled (default)

bit 0 BIT ORDER: Set Order Bits are Transmitted

0 = Most Significant Bit Transmitted First (default)

1 = Least Significant Bit Transmitted First

Data is always shifted into the part most significant bit first. Data is always shifted out of the part most significant byte first. This configuration bit only controls the bit order within the byte of data that is shifted out.

MUX (Address 01_H) Multiplexer Control Register

Reset Value = 01_H

bit 7	bit 6	bit 5	bit 4	bit 3	bit 2	bit 1	bit 0
PSEL3	PSEL2	PSEL1	PSEL0	NSEL3	NSEL2	NSEL1	NSEL0

bit 7-4 PSEL3: PSEL2: PSEL1: PSEL0: Positive Channel Select

0000 = AIN0 (default)

0001 = AIN1

0010 = AIN2

0011 = AIN3

0100 = AIN4

0101 = AIN5

0110 = AIN6

0111 = AIN7

1xxx = AINCOM (except when all bits are 1s)

1111 = Temperature Sensor Diode

bit 3-0 NSEL3: NSEL2: NSEL1: NSEL0: Negative Channel Select

0000 = AIN0

0001 = AIN1 (default)

0010 = AIN2

0011 = AIN3

0100 = AIN4

0101 = AIN5

0110 = AIN6

0111 = AIN7

1xxx = AINCOM (except when all bits are 1s)

1111 = Temperature Sensor Diode

ACR (Address 02_H) Analog Control RegisterReset Value = 00_H

bit 7	bit 6	bit 5	bit 4	bit 3	bit 2	bit 1	bit 0
BOCS	IDAC2R1	IDAC2R0	IDAC1R1	IDAC1R0	PGA2	PGA1	PGA0

bit 7 BOCS: Burnout Current Source
0 = Disabled (default)
1 = Enabled

$$\text{IDAC Current} = \left(\frac{V_{\text{REF}}}{8R_{\text{DAC}}} \right) \left(2^{\text{RANGE}-1} \right) (\text{DAC Code})$$

bit 6-5 IDAC2R1: IDAC2R0: Full-Scale Range Select for IDAC2

00 = Off (default)
01 = Range 1
10 = Range 2
11 = Range 3

bit 4-3 IDAC1R1: IDAC1R0: Full-Scale Range Select for IDAC1

00 = Off (default)
01 = Range 1
10 = Range 2
11 = Range 3

bit 2-0 PGA2: PGA1: PGA0: Programmable Gain Amplifier Gain Selection

000 = 1 (default)
001 = 2
010 = 4
011 = 8
100 = 16
101 = 32
110 = 64
111 = 128

IDAC1 (Address 03_H) Current DAC 1Reset Value = 00_H

bit 7	bit 6	bit 5	bit 4	bit 3	bit 2	bit 1	bit 0
IDAC1_7	IDAC1_6	IDAC1_5	IDAC1_4	IDAC1_3	IDAC1_2	IDAC1_1	IDAC1_0

The DAC code bits set the output of DAC1 from 0 to full-scale. The value of the full-scale current is set by this Byte, V_{REF} , R_{DAC} , and the DAC1 range bits in the ACR register.

IDAC2 (Address 04_H) Current DAC 2Reset Value = 00_H

bit 7	bit 6	bit 5	bit 4	bit 3	bit 2	bit 1	bit 0
IDAC2_7	IDAC2_6	IDAC2_5	IDAC2_4	IDAC1_3	IDAC1_2	IDAC1_1	IDAC1_0

The DAC code bits set the output of DAC2 from 0 to full-scale. The value of the full-scale current is set by this Byte, V_{REF} , R_{DAC} , and the DAC2 range bits in the ACR register.

ODAC (Address 05_H) Offset DAC SettingReset Value = 00_H

bit 7	bit 6	bit 5	bit 4	bit 3	bit 2	bit 1	bit 0
SIGN	OSET6	OSET5	OSET4	OSET3	OSET2	OSET1	OSET0

bit 7 Offset Sign
0 = Positive
1 = Negative

$$\text{bit 6-0 Offset} = \frac{V_{\text{REF}}}{\text{PGA}} \cdot \left(\frac{\text{Code}}{127} \right)$$

NOTE: The offset must be used after calibration or the calibration will notify the effects.

DIO (Address 06_H) Digital I/OReset Value = 00_H

bit 7	bit 6	bit 5	bit 4	bit 3	bit 2	bit 1	bit 0
DIO7	DIO6	DIO5	DIO4	DIO3	DIO2	DIO1	DIO0

A value written to this register will appear on the digital I/O pins if the pin is configured as an output in the DIR register. Reading this register will return the value of the digital I/O pins.

DIR (Address 07_H) Direction control for digital I/OReset Value = FF_H

bit 7	bit 6	bit 5	bit 4	bit 3	bit 2	bit 1	bit 0
DIR7	DIR6	DIR5	DIR4	DIR3	DIR2	DIR1	DIR0

Each bit controls whether the Digital I/O pin is an output (= 0) or input (= 1). The default power-up state is as inputs.

DEC0 (Address 08_H) Decimation Register
(Least Significant 8 bits)Reset Value = 80_H

bit 7	bit 6	bit 5	bit 4	bit 3	bit 2	bit 1	bit 0
DEC07	DEC06	DEC05	DEC04	DEC03	DEC02	DEC01	DEC00

The decimation value is defined with 11 bits for a range of 20 to 2047. This register is the least significant 8 bits. The 3 most significant bits are contained in the M/DEC1 register. The default data rate is 10Hz with a 2.4576MHz crystal.

M/DEC1 (Address 09_H) Mode and Decimation RegisterReset Value = 07_H

bit 7	bit 6	bit 5	bit 4	bit 3	bit 2	bit 1	bit 0
DRDY	U/B	SMODE1	SMODE0	Reserved	DEC10	DEC09	DEC08

bit 7 DRDY: Data Ready (Read Only) _____
This bit duplicates the state of the DRDY pin.

bit 6 U/B: Data Format
0 = Bipolar (default)
1 = Unipolar

U/B	ANALOG INPUT	DIGITAL OUTPUT
0	+FS	0x7FFFFFFF
	Zero	0x000000
	-FS	0x800000
1	+FS	0xFFFFFFFF
	Zero	0x000000
	-FS	0x000000

bit 5-4 SMODE1: SMODE0: Settling Mode
00 = Auto (default)
01 = Fast Settling filter
10 = Sinc² filter
11 = Sinc³ filter

bit 2-0 DEC10: DEC09: DEC08: Most Significant Bits of the Decimation Value

OCR0 (Address 0A_H) Offset Calibration Coefficient (Least Significant Byte)Reset Value = 00_H

bit 7	bit 6	bit 5	bit 4	bit 3	bit 2	bit 1	bit 0
OCR07	OCR06	OCR05	OCR04	OCR03	OCR02	OCR01	OCR00

OCR1 (Address 0B_H) Offset Calibration Coefficient (Middle Byte)Reset Value = 00_H

bit 7	bit 6	bit 5	bit 4	bit 3	bit 2	bit 1	bit 0
OCR15	OCR14	OCR13	OCR12	OCR11	OCR10	OCR09	OCR08

OCR2 (Address 0C_H) Offset Calibration Coefficient

(Most Significant Byte)

Reset Value = 00_H

bit 7	bit 6	bit 5	bit 4	bit 3	bit 2	bit 1	bit 0
OCR23	OCR22	OCR21	OCR20	OCR19	OCR18	OCR17	OCR16

FSR0 (Address 0D_H) Full-Scale Register (Least Significant Byte)Reset Value = 24_H

bit 7	bit 6	bit 5	bit 4	bit 3	bit 2	bit 1	bit 0
FSR07	FSR06	FSR05	FSR04	FSR03	FSR02	FSR01	FSR00

FSR1 (Address 0E_H) Full-Scale Register (Middle Byte)Reset Value = 90_H

bit 7	bit 6	bit 5	bit 4	bit 3	bit 2	bit 1	bit 0
FSR15	FSR14	FSR13	FSR12	FSR11	FSR10	FSR09	FSR08

FSR2 (Address 0F_H) Full-Scale Register (Most Significant Byte)Reset Value = 67_H

bit 7	bit 6	bit 5	bit 4	bit 3	bit 2	bit 1	bit 0
FSR23	FSR22	FSR21	FSR20	FSR19	FSR18	FSR17	FSR16

COMMAND DEFINITIONS

The commands listed below control the operation of the ADS1217. Some of the commands are stand-alone commands (e.g., RESET) while others require additional bytes (e.g., WREG requires command, count, and the data bytes). Commands that output data require a minimum of four f_{OSC} cycles before the data is ready (e.g., RDATA).

Operands:

n = count (0 to 127)

r = register (0 to 15)

x = don't care

a = RAM bank address (0 to 7)

COMMANDS	DESCRIPTION	COMMAND BYTE	2ND COMMAND BYTE
RDATA	Read Data	0000 0001 (01 _H)	—
RDATA_C	Read Data Continuously	0000 0011 (03 _H)	—
STOPC	Stop Read Data Continuously	0000 1111 (0F _H)	—
RREG	Read from REG Bank <i>rrrr</i>	0001 <i>rrrr</i> (1x _H)	xxxx_nnnn (# of reg-1)
RRAM	Read from RAM Bank <i>aaa</i>	0010 0aaa (2x _H)	xnnn_nnnn (# of bytes-1)
CREG	Copy REGs to RAM Bank <i>aaa</i>	0100 0aaa (4x _H)	—
CREGA	Copy REGs to all RAM Banks	0100 1000 (48 _H)	—
WREG	Write to REG <i>rrrr</i>	0101 <i>rrrr</i> (5x _H)	xxxx_nnnn (# of reg-1)
WRAM	Write to RAM Bank <i>aaa</i>	0110 0aaa (6x _H)	xnnn_nnnn (# of bytes-1)
CRAM	Copy RAM Bank <i>aaa</i> to REG	1100 0aaa (Cx _H)	—
CSRAMX	Calc RAM Bank <i>aaa</i> Checksum	1101 0aaa (Dx _H)	—
CSARAMX	Calc all RAM Bank Checksum	1101 1000 (D8 _H)	—
CSREG	Calc REG Checksum	1101 1111 (DF _H)	—
CSRAM	Calc RAM Bank <i>aaa</i> Checksum	1110 0aaa (Ex _H)	—
CSARAM	Calc all RAM Banks Checksum	1110 1000 (E8 _H)	—
SELFCAL	Self Cal Offset and Gain	1111 0000 (F0 _H)	—
SELFOCAL	Self Cal Offset	1111 0001 (F1 _H)	—
SELFGCAL	Self Cal Gain	1111 0010 (F2 _H)	—
YSOCAL	Sys Cal Offset	1111 0011 (F3 _H)	—
YSGCAL	Sys Cal Gain	1111 0100 (F4 _H)	—
WAKEUP	Wake Up From Sleep Mode	1111 1011 (FB _H)	—
DSYNC	Sync DRDY	1111 1100 (FC _H)	—
SLEEP	Put in Sleep Mode	1111 1101 (FD _H)	—
RESET	Reset to Power-Up Values	1111 1110 (FE _H)	—

NOTE: (1) The data received by the A/D converter is always MSB First, the data out format is set by the BIT ORDER bit in ACR reg.

TABLE III. Command Summary.

RDATA

Read Data

Description: Read a single 24-bit ADC conversion result. On completion of read back, DRDY goes HIGH.

Operands: None

Bytes: 1

Encoding: 0000 0001

Data Transfer Sequence:

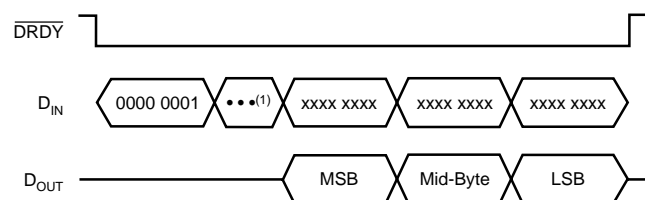

RDATA_C

Read Data Continuous

Description: Read Data Continuous mode enables the continuous output of new data on each DRDY. This command eliminates the need to send the Read Data Command on each DRDY. This mode may be terminated by either the STOP Read Continuous command or the RESET command.

Operands: None

Bytes: 1

Encoding: 0000 0011

Data Transfer Sequence:

Command terminated when *uuuu uuuu* equals STOPC or RESET.

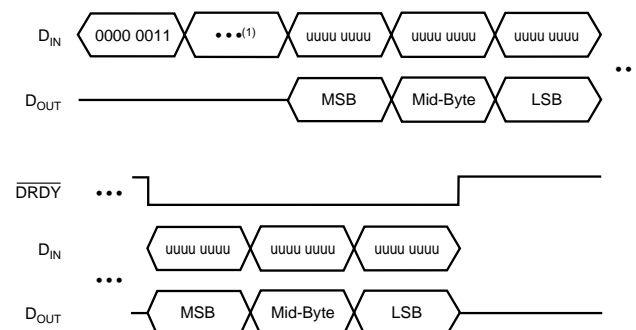

NOTE: (1) For wait time, refer to timing specification.

STOPC

Stop Continuous

Description: Ends the continuous data output mode.

Operands: None

Bytes: 1

Encoding: 0000 1111

Data Transfer Sequence:

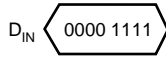

RREG

Read from Registers

Description: Output the data from up to 16 registers starting with the register address specified as part of the instruction. The number of registers read will be one plus the second byte. If the count exceeds the remaining registers, the addresses will wrap back to the beginning.

Operands: r, n

Bytes: 2

Encoding: 0001 rrrr xxxx nnnn

Data Transfer Sequence:

Read Two Registers Starting from Register 01_H (MUX)

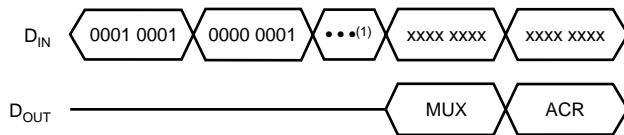

RRAM

Read from RAM

Description: Up to 128 bytes can be read from RAM starting at the bank specified in the op code. All reads start at the address for the beginning of the RAM bank. The number of bytes to read will be one plus the value of the second byte.

Operands: a, n

Bytes: 2

Encoding: 0010 0aaa xnnn nnnn

Data Transfer Sequence:

Read Two RAM Locations Starting from 20_H

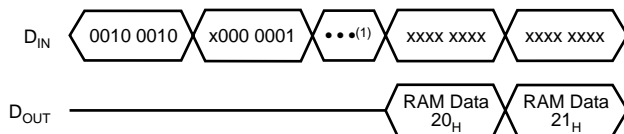

CREG

Copy Registers to RAM Bank

Description: Copy the 16 control registers to the RAM bank specified in the op code. Refer to timing specifications for command execution time.

Operands: a

Bytes: 1

Encoding: 0100 0aaa

Data Transfer Sequence:

Copy Register Values to RAM Bank 3

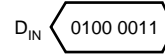

CREGA

Copy Registers to All RAM Banks

Description: Duplicate the 16 control registers to all the RAM banks. Refer to timing specifications for command execution time.

Operands: None

Bytes: 1

Encoding: 0100 1000

Data Transfer Sequence:

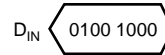

WREG

Write to Register

Description: Write to the registers starting with the register specified as part of the instruction. The number of registers that will be written is one plus the value of the second byte.

Operands: r, n

Bytes: 2

Encoding: 0101 rrrr xxxx nnnn

Data Transfer Sequence:

Write Two Registers Starting from 06_H (DIO)

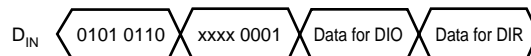

NOTE: (1) For wait time, refer to timing specification.

WRAM

Write to RAM

Description: Write up to 128 RAM locations starting at the beginning of the RAM bank specified as part of the instruction. The number of bytes written to RAM is one plus the value of the second byte.

Operands: a, n

Bytes: 2

Encoding: 0110 0aaa xnnn nnnn

Data Transfer Sequence:

Write to Two RAM Locations starting from 10_H

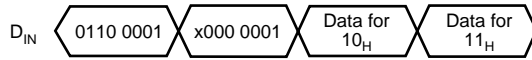

CRAM

Copy RAM Bank to Registers

Description: Copy the selected RAM Bank to the Configuration Registers. This will overwrite all of the registers with the data from the RAM bank.

Operands: a

Bytes: 1

Encoding: 1100 0aaa

Data Transfer Sequence:

Copy RAM Bank 0 to the Registers

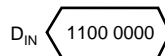

CSRAMX

Calculate RAM Bank Checksum

Description: Calculate the checksum of the selected RAM Bank. The checksum is calculated as a sum of all the bytes with the carry ignored. The ID, $\overline{\text{DRDY}}$, and DIO bits are masked so they are not included in the checksum.

Operands: a

Bytes: 1

Encoding: 1101 0aaa

Data Transfer Sequence:

Calculate Checksum for RAM Bank 3

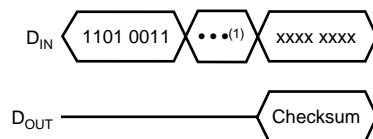

CSARAMX

Calculate the Checksum for all RAM Banks

Description: Calculate the checksum of all RAM Banks. The checksum is calculated as a sum of all the bytes with the carry ignored. The ID, $\overline{\text{DRDY}}$, and DIO bits are masked so they are not included in the checksum.

Operands: None

Bytes: 1

Encoding: 1101 1000

Data Transfer Sequence:

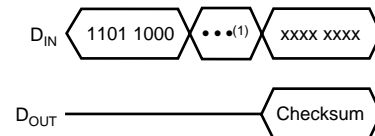

CSREG

Calculate the Checksum of Registers

Description: Calculate the checksum of all the registers. The checksum is calculated as a sum of all the bytes with the carry ignored. The ID, $\overline{\text{DRDY}}$ and DIO bits are masked so they are not included in the checksum.

Operands: None

Bytes: 1

Encoding: 1101 1111

Data Transfer Sequence:

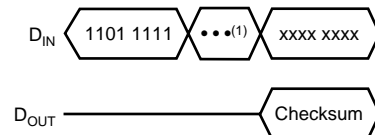

CSRAM

Calculate RAM Bank Checksum

Description: Calculate the checksum of the selected RAM Bank. The checksum is calculated as a sum of all the bytes with the carry ignored. All bits are included in the checksum calculation, there is no masking of bits.

Operands: a

Bytes: 1

Encoding: 1110 0aaa

Data Transfer Sequence:

Calculate Checksum for RAM Bank 2

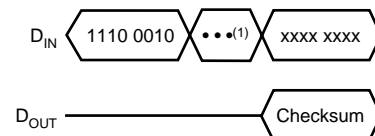

NOTE: (1) For wait time, refer to timing specification.

CSARAM

Calculate Checksum for all RAM Banks

Description: Calculate the checksum of all RAM Banks. The checksum is calculated as a sum of all the bytes with the carry ignored. All bits are included in the checksum calculation, there is no masking of bits.

Operands: None

Bytes: 1

Encoding: 1110 1000

Data Transfer Sequence:

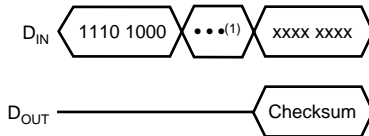

SELFCAL Offset and Gain Self Calibration

Description: Starts the process of self calibration. The Offset Control Register (OCR) and the Full-Scale Register (FSR) are updated with new values after this operation.

Operands: None

Bytes: 1

Encoding: 1111 0000

Data Transfer Sequence:

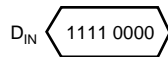

SELFOCAL Offset Self Calibration

Description: Starts the process of self-calibration for offset. The Offset Control Register (OCR) is updated after this operation.

Operands: None

Bytes: 1

Encoding: 1111 0001

Data Transfer Sequence:

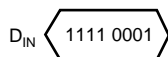

SELFGCAL

Gain Self Calibration

Description: Starts the process of self-calibration for gain. The Full-Scale Register (FSR) is updated with new values after this operation.

Operands: None

Bytes: 1

Encoding: 1111 0010

Data Transfer Sequence:

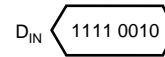

SYSOCAL System Offset Calibration

Description: Starts the system offset calibration process. For a system offset calibration the input should be set to 0V differential, and the ADS1217 computes the OCR register value that will compensate for offset errors. The Offset Control Register (OCR) is updated after this operation.

Operands: None

Bytes: 1

Encoding: 1111 0011

Data Transfer Sequence:

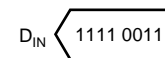

SYSGCAL System Gain Calibration

Description: Starts the system gain calibration process. For a system gain calibration, the differential input should be set to the reference voltage and the ADS1217 computes the FSR register value that will compensate for gain errors. The FSR is updated after this operation.

Operands: None

Bytes: 1

Encoding: 1111 0100

Data Transfer Sequence:

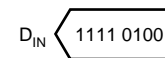

NOTE: (1) For wait time, refer to timing specification.

DSYNC

Sync DRDY

Description: Synchronizes the ADS1217 to the serial clock edge.

Operands: None

Bytes: 1

Encoding: 1111 1100

Data Transfer Sequence:



SLEEP

Sleep Mode

Description: Puts the ADS1217 into a low power sleep mode. SCLK must be inactive while in sleep mode. To exit this mode, issue the WAKEUP command.

Operands: None

Bytes: 1

Encoding: 1111 1101

Data Transfer Sequence:

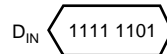

WAKEUP Wakeup From Sleep Mode

Description: Use this command to wake up from sleep mode.

Operands: None

Bytes: 1

Encoding: 1111 1011

Data Transfer Sequence:

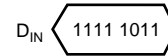

RESET Reset to Power-Up Values

Description: Restore the registers to their power-up values. This command will also stop the Read Continuous mode. It does not affect the contents of RAM.

Operands: None

Bytes: 1

Encoding: 1111 1110

Data Transfer Sequence:

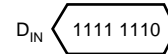

MSB	LSB															
	0000	0001	0010	0011	0100	0101	0110	0111	1000	1001	1010	1011	1100	1101	1110	1111
0000	x	rdata	x	rdatac	x	x	x	x	x	x	x	x	x	x	x	stopc
0001	rreg 0	rreg 1	rreg 2	rreg 3	rreg 4	rreg 5	rreg 6	rreg 7	rreg 8	rreg 9	rreg A	rreg B	rreg C	rreg D	rreg E	rreg F
0010	rram 0	rram 1	rram 2	rram 3	rram 4	rram 5	rram 6	rram 7	x	x	x	x	x	x	x	x
0011	x	x	x	x	x	x	x	x	x	x	x	x	x	x	x	x
0100	creg 0	creg 1	creg 2	creg 3	creg 4	creg 5	creg 6	creg 7	crega	x	x	x	x	x	x	x
0101	wreg 0	wreg 1	wreg 2	wreg 3	wreg 4	wreg 5	wreg 6	wreg 7	wreg 8	wreg 9	wreg A	wreg B	wreg C	wreg D	wreg E	wreg F
0110	wram 0	wram 1	wram 2	wram 3	wram 4	wram 5	wram 6	wram 7	x	x	x	x	x	x	x	x
0111	x	x	x	x	x	x	x	x	x	x	x	x	x	x	x	x
1000	x	x	x	x	x	x	x	x	x	x	x	x	x	x	x	x
1001	x	x	x	x	x	x	x	x	x	x	x	x	x	x	x	x
1010	x	x	x	x	x	x	x	x	x	x	x	x	x	x	x	x
1011	x	x	x	x	x	x	x	x	x	x	x	x	x	x	x	x
1100	cram 0	cram 1	cram 2	cram 3	cram 4	cram 5	cram 6	cram 7	x	x	x	x	x	x	x	x
1101	csramx 0	csramx 1	csramx 2	csramx 3	csramx 4	csramx 5	csramx 6	csramx 7	csa ramx	x	x	x	x	x	x	csreg
1110	cs ram 0	cs ram 1	cs ram2	cs ram 3	cs ram 4	cs ram 5	cs ram 6	cs ram 7	csa ram	x	x	x	x	x	x	x
1111	self cal	self ocal	self gcal	sys ocal	sys gcal	x	x	x	x	x	x	wakeup	dsync	sleep	reset	x

x = Reserved

TABLE IV. Command Map.

DEFINITION OF TERMS

Analog Input Voltage—the voltage at any one analog input relative to AGND.

Analog Input Differential Voltage—given by the following equation: $(A_{IN+}) - (A_{IN-})$. Thus, a positive digital output is produced whenever the analog input differential voltage is positive, while a negative digital output is produced whenever the differential is negative.

For example, when the converter is configured with a 2.5V reference and placed in a gain setting of 1, the positive full-scale output is produced when the analog input differential is $2 \cdot 2.5V$. The negative full-scale output is produced when the differential is $2 \cdot (-2.5V)$. In each case, the actual input voltages must remain within the AGND to AV_{DD} range.

Conversion Cycle—the term *conversion cycle* usually refers to a discrete A/D conversion operation, such as that performed by a successive approximation converter. As used here, a conversion cycle refers to the t_{DATA} time period. However, each digital output is actually based on the modulator results from several t_{DATA} time periods.

FILTER SETTING	MODULATOR RESULTS
Fast Settling	1 t_{DATA} Time Period
Sinc ²	2 t_{DATA} Time Period
Sinc ³	3 t_{DATA} Time Period

Data Rate—the rate at which conversions are completed. See definition for f_{DATA} .

Decimation Ratio—defines the ratio between the output of the modulator and the output Data Rate. Valid values for the Decimation Ratio are from 20 to 2047. Larger Decimation Ratios will have lower noise.

Effective Resolution—the effective resolution of the ADS1217 in a particular configuration can be expressed in two different units: bits rms (referenced to output) and V_{rms} (referenced to input). Computed directly from the converter's output data, each is a statistical calculation. The conversion from one to the other is shown below.

Effective number of bits (ENOB) or effective resolution is commonly used to define the usable resolution of the A/D converter. It is calculated from empirical data taken directly from the device. It is typically determined by applying a fixed known signal source to the analog input and computing the standard deviation of the data sample set. The rms noise defines the $\pm\sigma$ interval about the sample mean.

The data from the A/D converter is output as codes, which then can be easily converted to other units, such as ppm or volts. The equations and table below show the relationship between bits or codes, ppm, and volts.

$$ENOB = \frac{-20 \log(\text{ppm})}{6.02}$$

BITS rms	BIPOLAR V_{rms}	UNIPOLAR V_{rms}
	$\frac{\left(\frac{4V_{REF}}{PGA}\right)}{10^{\left(\frac{6.02 \cdot ENOB}{20}\right)}}$	$\frac{\left(\frac{2V_{REF}}{PGA}\right)}{10^{\left(\frac{6.02 \cdot ENOB}{20}\right)}}$
24	596nV	298nV
22	2.38 μ V	1.19 μ V
20	9.54 μ V	4.77 μ V
18	38.1 μ V	19.1 μ V
16	153 μ V	76.4 μ V
14	610 μ V	305 μ V
12	2.44mV	1.22mV

f_{DATA} —the frequency of the digital output data produced by the ADS1217, f_{DATA} is also referred to as the Data Rate.

$$f_{DATA} = \left(\frac{f_{MOD}}{\text{Decimation Ratio}}\right) = \left(\frac{f_{OSC}}{\text{mfactor} \cdot \text{Decimation Ratio}}\right)$$

f_{MOD} —the frequency or speed at which the modulator of the ADS1217 is running. This depends on the SPEED bit as shown below:

SPEED BIT	f_{MOD}
0	$f_{OSC}/128$
1	$f_{OSC}/256$

f_{OSC} —the frequency of the crystal input signal at the X_{IN} input of the ADS1217.

f_{SAMP} —the frequency, or switching speed, of the input sampling capacitor. The value is given by one of the following equations:

PGA SETTING	SAMPLING FREQUENCY
1, 2, 4, 8	$f_{SAMP} = \frac{f_{OSC}}{\text{mfactor}}$
8	$f_{SAMP} = \frac{2f_{OSC}}{\text{mfactor}}$
16	$f_{SAMP} = \frac{8f_{OSC}}{\text{mfactor}}$
32	$f_{SAMP} = \frac{16f_{OSC}}{\text{mfactor}}$
64, 128	$f_{SAMP} = \frac{16f_{OSC}}{\text{mfactor}}$

Filter Selection—the ADS1217 uses a (sinc/x) filter or *sinc* filter. There are three different sinc filters that can be selected. A fast settling filter will settle in one t_{DATA} cycle. The sinc² filter will settle in two cycles and have lower noise. The sinc³ will achieve lowest noise and higher number of effective bits, but requires three cycles to settle. The ADS1217 will operate with any one of these filters, or it can operate in an auto mode, where it will first select the fast settling filter after a new channel is selected and will then switch to sinc² for one reading, followed by sinc³ from then on.

Full-Scale Range (FSR)—as with most A/D converters, the full-scale range of the ADS1217 is defined as the “input”, which produces the positive full-scale digital output minus the “input”, which produces the negative full-scale digital output. The full-scale range changes with gain setting, see Table V.

For example, when the converter is configured with a 2.5V reference and is placed in a gain setting of 2, the full-scale range is: $2 \cdot [1.25\text{V (positive full-scale) minus } -1.25\text{V (negative full-scale)}] = 5\text{V}$.

Least Significant Bit (LSB) Weight—this is the theoretical amount of voltage that the differential voltage at the analog input would have to change in order to observe a change in the output data of one least significant bit. It is computed as follows:

$$\text{LSB Weight} = \frac{\text{Full - Scale Range}}{2^N}$$

where N is the number of bits in the digital output.

t_{DATA} —the inverse of f_{DATA} , or the period between each data output.

GAIN SETTING	5V SUPPLY ANALOG INPUT ⁽¹⁾			GENERAL EQUATIONS		
	FULL-SCALE RANGE	DIFFERENTIAL INPUT VOLTAGES ⁽²⁾	PGA OFFSET RANGE	FULL-SCALE RANGE	DIFFERENTIAL INPUT VOLTAGES ⁽²⁾	PGA SHIFT RANGE
1	10V	±5V	±2.5	$\frac{4V_{\text{REF}}}{\text{PGA}}$	$\frac{\pm 2V_{\text{REF}}}{\text{PGA}}$	$\frac{\pm V_{\text{REF}}}{\text{PGA}}$
2	5V	±2.5V	±1.25V			
4	2.5V	±1.25V	±0.625V			
8	1.25V	±0.625V	±312.5mV			
16	0.625V	±312.5mV	±156.25mV			
32	312.5mV	±156.25mV	±78.125mV			
64	156.25mV	±78.125mV	±39.0625mV			
128	78.125mV	±39.0625mV	±19.531mV			

NOTES: (1) With a 2.5V reference. (2) The ADS1217 allows common-mode voltage as long as the absolute input voltage on $A_{\text{IN}+}$ or $A_{\text{IN}-}$ does not go below AGND or above AV_{DD} .

TABLE V. Full-Scale Range versus PGA Setting.

Revision History

DATE	REVISION	PAGE	SECTION	DESCRIPTION
2/07	C	2,4	Electrical Characteristics	Changed Gain Error condition from "Before Calibration" to "After Calibration"

NOTE: Page numbers for previous revisions may differ from page numbers in the current version.

PACKAGING INFORMATION

Orderable Device	Status (1)	Package Type	Package Drawing	Pins	Package Qty	Eco Plan (2)	Lead finish/ Ball material (6)	MSL Peak Temp (3)	Op Temp (°C)	Device Marking (4/5)	Samples
ADS1217IPFBR	ACTIVE	TQFP	PFB	48	2000	RoHS & Green	NIPDAU	Level-2-260C-1 YEAR	-40 to 85	ADS1217	Samples
ADS1217IPFBT	ACTIVE	TQFP	PFB	48	250	RoHS & Green	NIPDAU	Level-2-260C-1 YEAR	-40 to 85	ADS1217	Samples
ADS1217IPFBTG4	ACTIVE	TQFP	PFB	48	250	RoHS & Green	NIPDAU	Level-2-260C-1 YEAR	-40 to 85	ADS1217	Samples

(1) The marketing status values are defined as follows:

ACTIVE: Product device recommended for new designs.

LIFEBUY: TI has announced that the device will be discontinued, and a lifetime-buy period is in effect.

NRND: Not recommended for new designs. Device is in production to support existing customers, but TI does not recommend using this part in a new design.

PREVIEW: Device has been announced but is not in production. Samples may or may not be available.

OBSOLETE: TI has discontinued the production of the device.

(2) **RoHS:** TI defines "RoHS" to mean semiconductor products that are compliant with the current EU RoHS requirements for all 10 RoHS substances, including the requirement that RoHS substance do not exceed 0.1% by weight in homogeneous materials. Where designed to be soldered at high temperatures, "RoHS" products are suitable for use in specified lead-free processes. TI may reference these types of products as "Pb-Free".

RoHS Exempt: TI defines "RoHS Exempt" to mean products that contain lead but are compliant with EU RoHS pursuant to a specific EU RoHS exemption.

Green: TI defines "Green" to mean the content of Chlorine (Cl) and Bromine (Br) based flame retardants meet JS709B low halogen requirements of <=1000ppm threshold. Antimony trioxide based flame retardants must also meet the <=1000ppm threshold requirement.

(3) MSL, Peak Temp. - The Moisture Sensitivity Level rating according to the JEDEC industry standard classifications, and peak solder temperature.

(4) There may be additional marking, which relates to the logo, the lot trace code information, or the environmental category on the device.

(5) Multiple Device Markings will be inside parentheses. Only one Device Marking contained in parentheses and separated by a "~" will appear on a device. If a line is indented then it is a continuation of the previous line and the two combined represent the entire Device Marking for that device.

(6) Lead finish/Ball material - Orderable Devices may have multiple material finish options. Finish options are separated by a vertical ruled line. Lead finish/Ball material values may wrap to two lines if the finish value exceeds the maximum column width.

Important Information and Disclaimer: The information provided on this page represents TI's knowledge and belief as of the date that it is provided. TI bases its knowledge and belief on information provided by third parties, and makes no representation or warranty as to the accuracy of such information. Efforts are underway to better integrate information from third parties. TI has taken and continues to take reasonable steps to provide representative and accurate information but may not have conducted destructive testing or chemical analysis on incoming materials and chemicals. TI and TI suppliers consider certain information to be proprietary, and thus CAS numbers and other limited information may not be available for release.

In no event shall TI's liability arising out of such information exceed the total purchase price of the TI part(s) at issue in this document sold by TI to Customer on an annual basis.

PFB (S-PQFP-G48)

PLASTIC QUAD FLATPACK

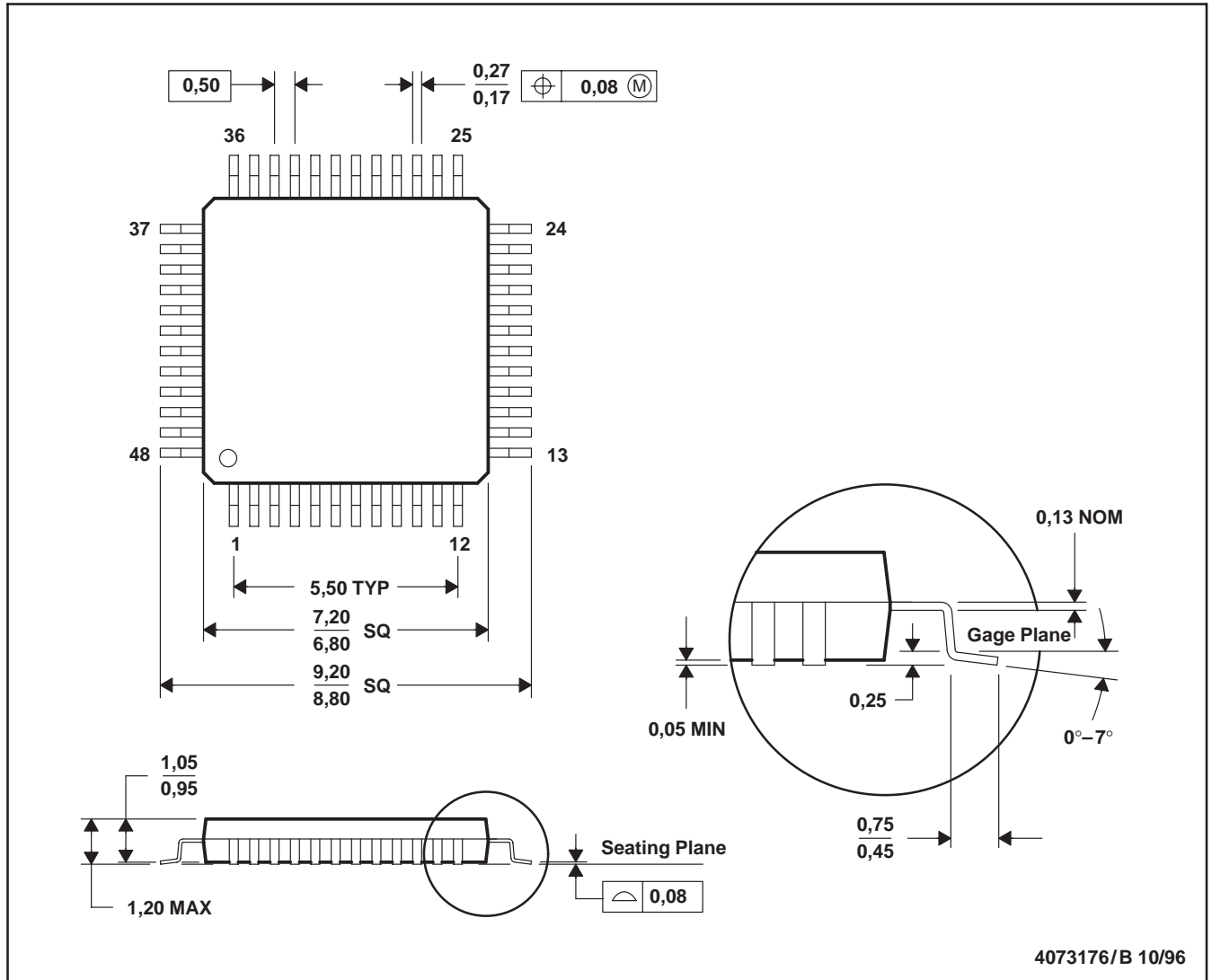

- NOTES: A. All linear dimensions are in millimeters.
 B. This drawing is subject to change without notice.
 C. Falls within JEDEC MS-026

PFB (S-PQFP-G48)



- NOTES:
- A. All linear dimensions are in millimeters.
 - B. This drawing is subject to change without notice.
 - C. Publication IPC-7351 is recommended for alternate designs.
 - D. Laser cutting apertures with trapezoidal walls and also rounding corners will offer better paste release. Customers should contact their board assembly site for stencil design recommendations. Refer to IPC-7525.
 - E. Customers should contact their board fabrication site for solder mask tolerances between and around signal pads.

IMPORTANT NOTICE AND DISCLAIMER

TI PROVIDES TECHNICAL AND RELIABILITY DATA (INCLUDING DATASHEETS), DESIGN RESOURCES (INCLUDING REFERENCE DESIGNS), APPLICATION OR OTHER DESIGN ADVICE, WEB TOOLS, SAFETY INFORMATION, AND OTHER RESOURCES "AS IS" AND WITH ALL FAULTS, AND DISCLAIMS ALL WARRANTIES, EXPRESS AND IMPLIED, INCLUDING WITHOUT LIMITATION ANY IMPLIED WARRANTIES OF MERCHANTABILITY, FITNESS FOR A PARTICULAR PURPOSE OR NON-INFRINGEMENT OF THIRD PARTY INTELLECTUAL PROPERTY RIGHTS.

These resources are intended for skilled developers designing with TI products. You are solely responsible for (1) selecting the appropriate TI products for your application, (2) designing, validating and testing your application, and (3) ensuring your application meets applicable standards, and any other safety, security, or other requirements. These resources are subject to change without notice. TI grants you permission to use these resources only for development of an application that uses the TI products described in the resource. Other reproduction and display of these resources is prohibited. No license is granted to any other TI intellectual property right or to any third party intellectual property right. TI disclaims responsibility for, and you will fully indemnify TI and its representatives against, any claims, damages, costs, losses, and liabilities arising out of your use of these resources.

TI's products are provided subject to TI's Terms of Sale (<https://www.ti.com/legal/termsofsale.html>) or other applicable terms available either on [ti.com](https://www.ti.com) or provided in conjunction with such TI products. TI's provision of these resources does not expand or otherwise alter TI's applicable warranties or warranty disclaimers for TI products.

Mailing Address: Texas Instruments, Post Office Box 655303, Dallas, Texas 75265
Copyright © 2021, Texas Instruments Incorporated