

20A, 100V - 200V Trench Schottky Rectifier

FEATURES

- Patented Trench Schottky technology
- Excellent high temperature stability
- Low forward voltage
- Low power loss/ High efficiency
- High forward surge capability
- RoHS Compliant
- Halogen-free according to IEC 61249-2-21

APPLICATIONS

- Switching mode power supply (SMPS)
- Adapters
- DC to DC converters

MECHANICAL DATA

- Case: TO-220AB
- Molding compound meets UL 94V-0 flammability rating
- Terminal: Matte tin plated leads, solderable per J-STD-002
- Mounting torque: 0.56 N·m maximum
- Meet JESD 201 class 2 whisker test
- Polarity: As marked
- Weight: 1.88g (approximately)

KEY PARAMETERS		
PARAMETER	VALUE	UNIT
I_F	20	A
V_{RRM}	100 - 200	V
I_{FSM}	100	A
T_{JMAX}	150	°C
Package	TO-220AB	
Configuration	Dual dies	

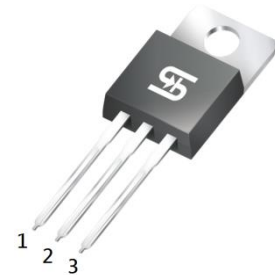

TO-220AB

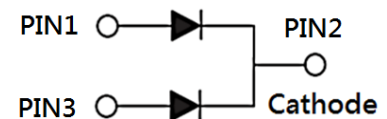

ABSOLUTE MAXIMUM RATINGS ($T_A = 25^\circ\text{C}$ unless otherwise noted)						
PARAMETER	SYMBOL	TST20L 100CW	TST20L 120CW	TST20L 150CW	TST20L 200CW	UNIT
Marking code on the device		TST20L 100CW	TST20L 120CW	TST20L 150CW	TST20L 200CW	
Repetitive peak reverse voltage	V_{RRM}	100	120	150	200	V
Reverse voltage, total rms value	$V_{R(RMS)}$	70	84	105	140	V
Forward current	I_F	20				A
Surge peak forward current, 8.3ms single half sine wave superimposed on rated load	I_{FSM}	100				A
Critical rate of rise of off-state voltage	dv/dt	10,000				V/ μs
Junction temperature	T_J	-55 to +150				°C
Storage temperature	T_{STG}	-55 to +150				°C

THERMAL PERFORMANCE			
PARAMETER	SYMBOL	TYP	UNIT
Junction-to-case thermal resistance	$R_{\theta JC}$	3.2	°C/W

ELECTRICAL SPECIFICATIONS ($T_A = 25^\circ\text{C}$ unless otherwise noted)						
PARAMETER		CONDITIONS	SYMBOL	TYP	MAX	UNIT
Forward voltage per diode ⁽¹⁾	TST20L100CW	$I_F = 5\text{A}, T_J = 25^\circ\text{C}$	V_F	0.62	-	V
	TST20L120CW			0.69	-	V
	TST20L150CW			0.78	-	V
	TST20L200CW			0.81	-	V
	TST20L100CW	$I_F = 10\text{A}, T_J = 25^\circ\text{C}$		-	0.84	V
	TST20L120CW			-	0.93	V
	TST20L150CW			-	0.96	V
	TST20L200CW			-	0.99	V
	TST20L100CW	$I_F = 5\text{A}, T_J = 125^\circ\text{C}$		0.55	-	V
	TST20L120CW			0.58	-	V
	TST20L150CW			0.64	-	V
	TST20L200CW			0.67	-	V
	TST20L100CW	$I_F = 10\text{A}, T_J = 125^\circ\text{C}$		0.65	0.74	V
	TST20L120CW			0.69	0.78	V
	TST20L150CW			0.72	0.81	V
	TST20L200CW			0.75	0.84	V
Reverse current @ rated V_R per diode ⁽²⁾	TST20L100CW TST20L120CW TST20L150CW TST20L200CW	$T_J = 25^\circ\text{C}$	I_R	-	100	μA
	TST20L100CW TST20L120CW	$T_J = 125^\circ\text{C}$		-	15	mA
	TST20L150CW TST20L200CW			-	10	mA

Notes:

1. Pulse test with $PW = 0.3\text{ms}$
2. Pulse test with $PW = 30\text{ms}$

ORDERING INFORMATION		
ORDERING CODE⁽¹⁾	PACKAGE	PACKING
TST20LxCW	TO-220AB	50 / Tube

Notes:

1. "x" defines voltage from 100V(TST20L100CW) to 200V(TST20L200CW)

CHARACTERISTICS CURVES

($T_A = 25^\circ\text{C}$ unless otherwise noted)

Fig.1 Forward Current Derating Curve

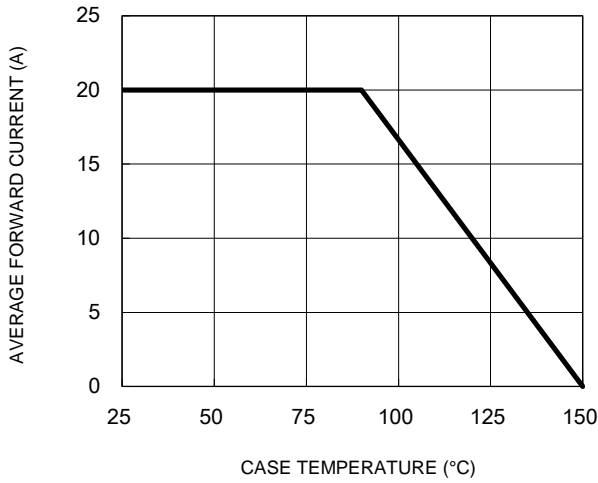

Fig.2 Typical Junction Capacitance

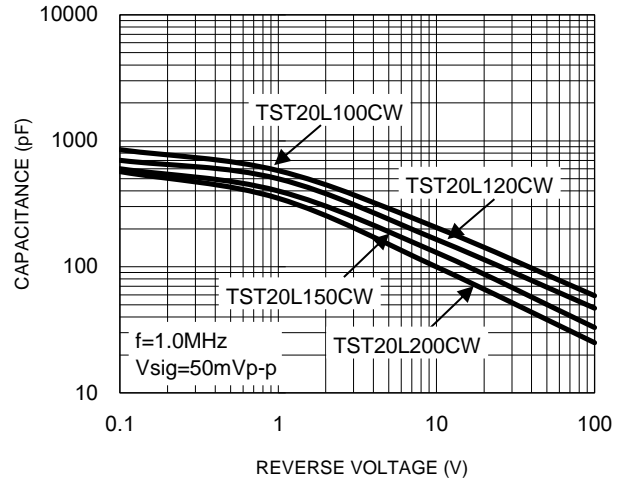

Fig.3 Typical Reverse Characteristics

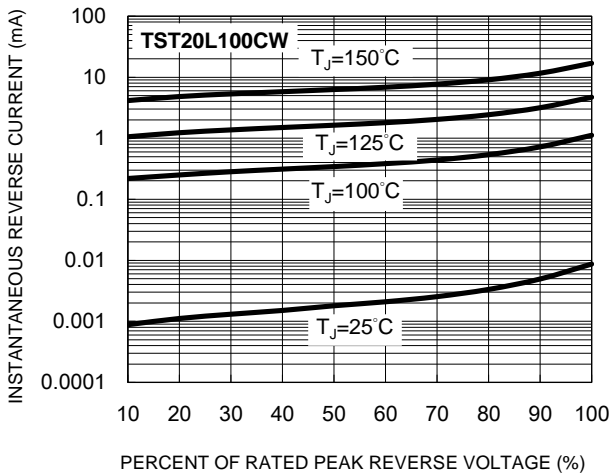

Fig.4 Typical Forward Characteristics

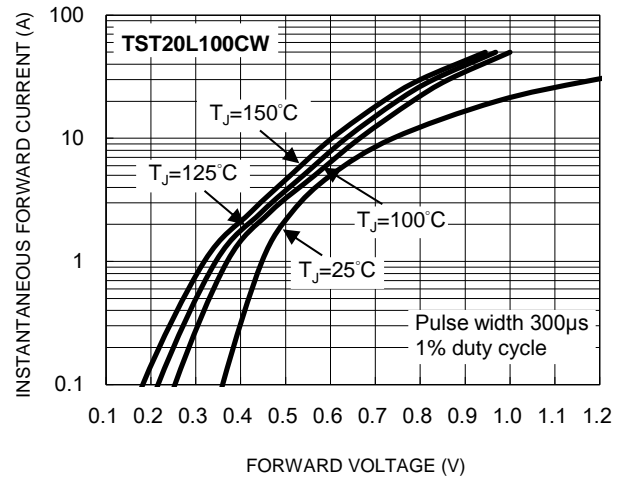

Fig.5 Typical Reverse Characteristics

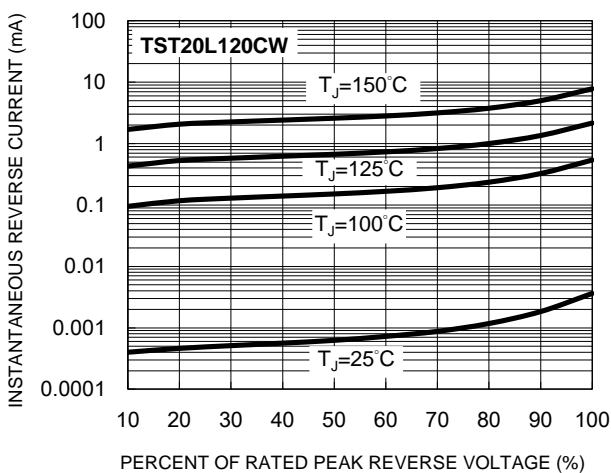
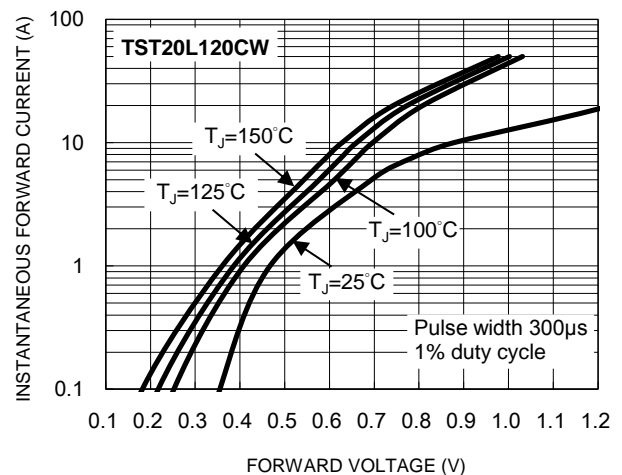

Fig.6 Typical Forward Characteristics



CHARACTERISTICS CURVES

($T_A = 25^\circ\text{C}$ unless otherwise noted)

Fig.7 Typical Reverse Characteristics

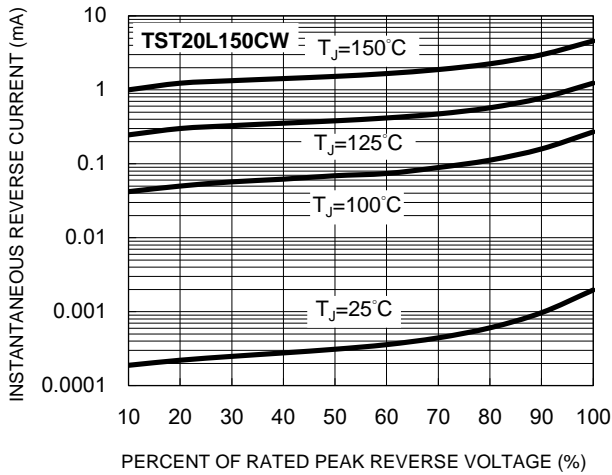

Fig.8 Typical Forward Characteristics

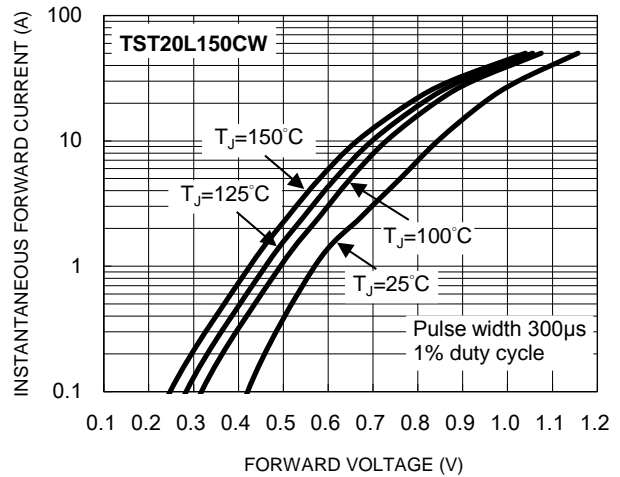

Fig.9 Typical Reverse Characteristics

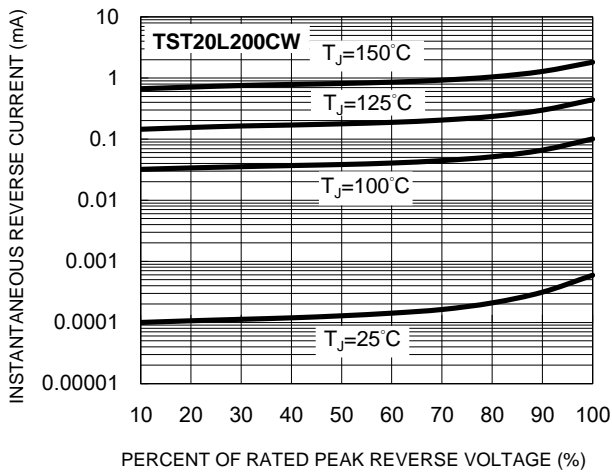
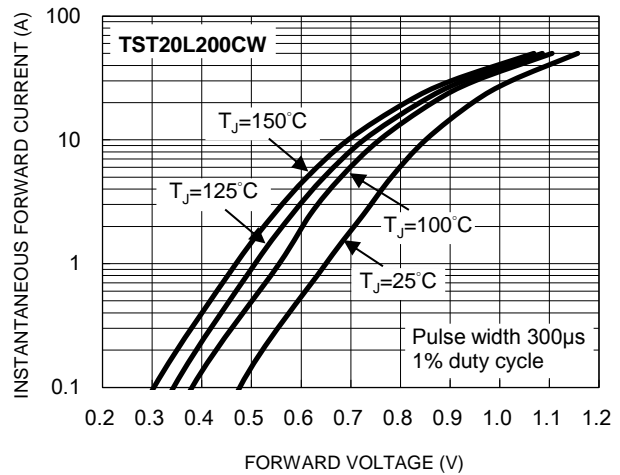
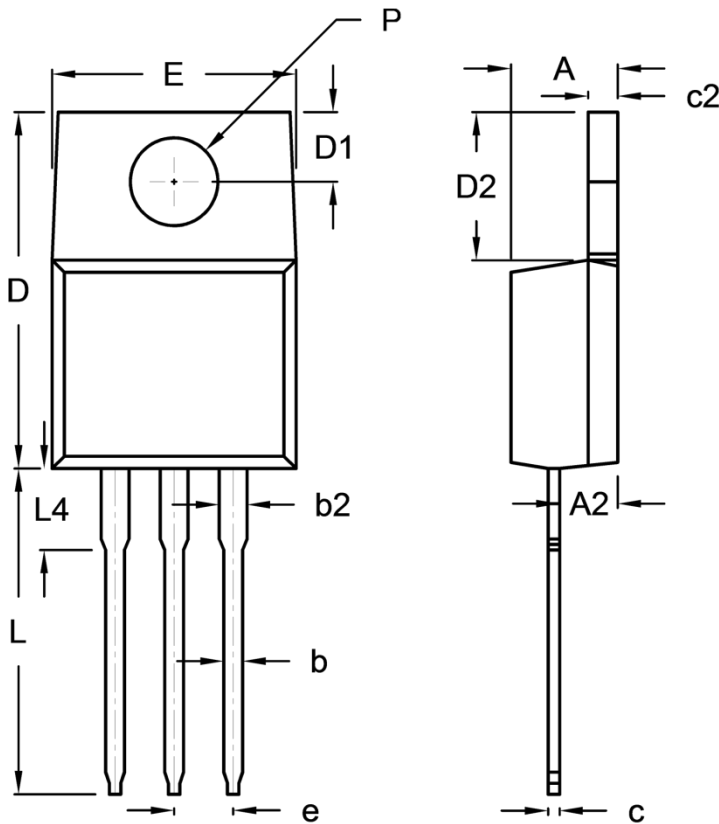

Fig.10 Typical Forward Characteristics



PACKAGE OUTLINE DIMENSIONS

TO-220AB



DIM.	Unit (mm)		Unit (inch)	
	Min.	Max.	Min.	Max.
A	4.42	4.76	0.174	0.187
A2	2.20	2.80	0.087	0.110
b	0.68	0.94	0.027	0.037
b2	0.95	1.45	0.037	0.057
c	0.35	0.64	0.014	0.025
c2	1.14	1.40	0.045	0.055
D	14.60	16.00	0.575	0.630
D1	2.54	3.44	0.100	0.135
D2	5.84	6.86	0.230	0.270
E	-	10.50	-	0.413
e	2.41	2.67	0.095	0.105
L	13.19	14.79	0.519	0.582
L4	2.80	4.20	0.110	0.165
P	3.54	4.00	0.139	0.157

MARKING DIAGRAM



- P/N = Marking Code
- G = Green Compound
- YWW = Date Code
- F = Factory Code

Notice

Specifications of the products displayed herein are subject to change without notice. TSC or anyone on its behalf assumes no responsibility or liability for any errors or inaccuracies.

Purchasers are solely responsible for the choice, selection, and use of TSC products and TSC assumes no liability for application assistance or the design of Purchasers' products.

Information contained herein is intended to provide a product description only. No license, express or implied, to any intellectual property rights is granted by this document. Except as provided in TSC's terms and conditions of sale for such products, TSC assumes no liability whatsoever, and disclaims any express or implied warranty, relating to sale and/or use of TSC products including liability or warranties relating to fitness for a particular purpose, merchantability, or infringement of any patent, copyright, or other intellectual property right.

The products shown herein are not designed for use in medical, life-saving, or life-sustaining applications. Customers using or selling these products for use in such applications do so at their own risk and agree to fully indemnify TSC for any damages resulting from such improper use or sale.