

# CMOS Voltage Regulator, Very Low Dropout Bias Rail, 500 mA

## NCP135

The NCP135 is a 500 mA VLDO equipped with NMOS pass transistor and a separate bias supply voltage ( $V_{BIAS}$ ). The device provides very stable, accurate output voltage with low noise suitable for space constrained, noise sensitive applications. In order to optimize performance for battery operated portable applications, the NCP135 features low  $I_Q$  consumption. The NCP135 is offered in WDFN6 2 mm x 2 mm package.

### Features

- Input Voltage Range: 0.4 V to 5.5 V
- Bias Voltage Range: 2.5 V to 5.5 V
- Fixed Output Voltage of 0.4 V and 0.75 V
- $\pm 1\%$  Accuracy over Temperature, 0.5%  $V_{OUT}$  @ 25°C
- Ultra-Low Dropout: Typ. 53 mV at 500 mA
- Very Low Bias Input Current of Typ. 35  $\mu$ A
- Logic Level Enable Input for ON/OFF Control
- Output Active Discharge Option Available
- Stable with a 10  $\mu$ F Ceramic Capacitor
- Available in WDFN6 2 mm x 2 mm, 0.65 mm pitch Package
- This is a Pb-Free Device

### Typical Applications

- Battery-powered Equipment
- Smartphones, Tablets
- Cameras, DVRs, STB and Camcorders

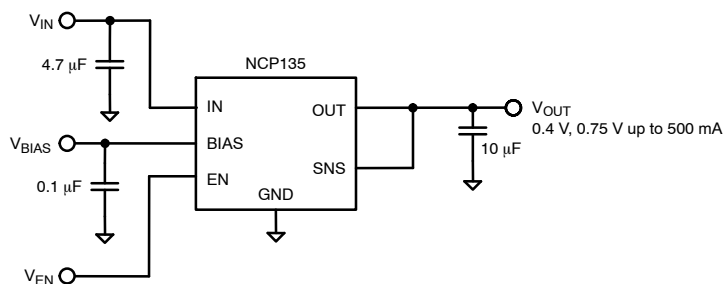
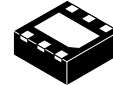

Figure 1. Typical Application Schematic



ON Semiconductor®

[www.onsemi.com](http://www.onsemi.com)



WDFN6  
CASE 511BR

### MARKING DIAGRAM

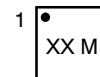

XX = Specific Device Code  
M = Date Code

### PIN CONNECTIONS

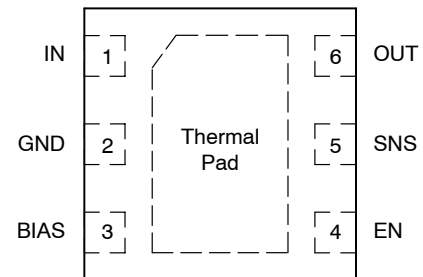

(Top View)

### ORDERING INFORMATION

See detailed ordering, marking and shipping information on page 10 of this data sheet.

# NCP135

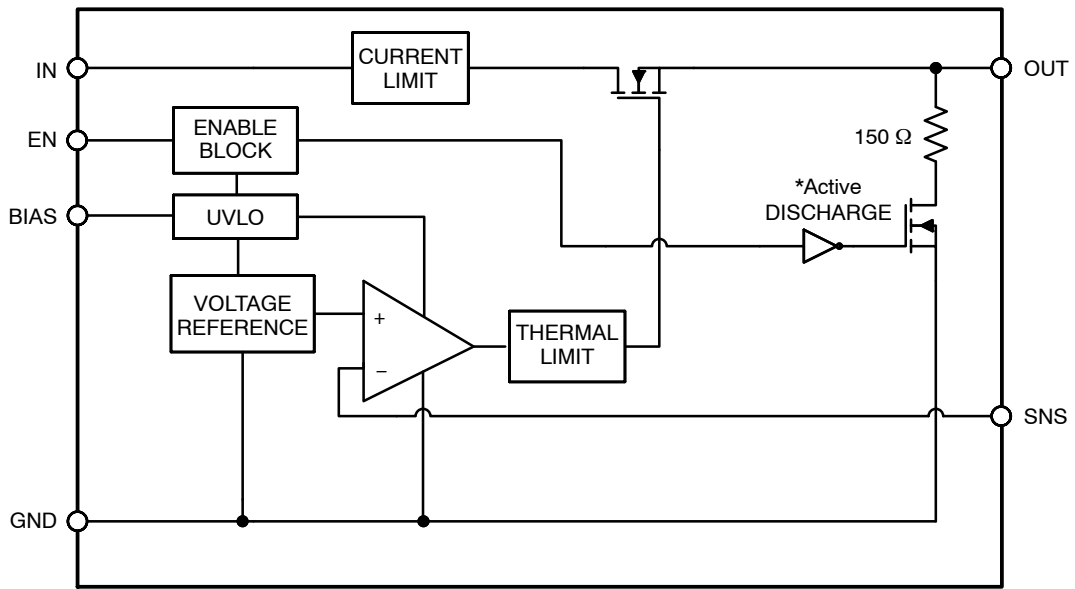

\*Active output discharge function is present only in NCP135A option devices.

**Figure 2. Simplified Schematic Block Diagram**

# NCP135

## PIN FUNCTION DESCRIPTION

Pin No.	Pin Name	Description
1	VIN	Input Voltage Supply pin
2	GND	Ground pin
3	VBIAS	Bias voltage supply for internal control circuits. This pin is monitored by internal Under-Voltage Lockout Circuit.
4	EN	Enable pin. Driving this pin high enables the regulator. Driving this pin low puts the regulator into shutdown mode.
5	SNS	Output voltage Sensing Input. Connect to Output voltage node on the PCB.
6	VOOUT	Regulated Output Voltage pin
Pad	Pad	Should be soldered to the ground plane for increased thermal performance.

## ABSOLUTE MAXIMUM RATINGS

Rating	Symbol	Value	Unit
Input Voltage (Note 1)	$V_{IN}$	-0.3 to 6	V
Output Voltage	$V_{OUT}$	-0.3 to $(V_{IN}+0.3) \leq 6$	V
Chip Enable, Bias and SNS Input	$V_{EN}, V_{BIAS}, V_{SNS}$	-0.3 to 6	V
Output Short Circuit Duration	$t_{SC}$	unlimited	s
Maximum Junction Temperature	$T_J$	125	°C
Storage Temperature	$T_{STG}$	-55 to 150	°C
ESD Capability, Human Body Model (Note 2)	$ESD_{HBM}$	2000	V
ESD Capability, Machine Model (Note 2)	$ESD_{MM}$	200	V

Stresses exceeding those listed in the Maximum Ratings table may damage the device. If any of these limits are exceeded, device functionality should not be assumed, damage may occur and reliability may be affected.

- Refer to ELECTRICAL CHARACTERISTICS and APPLICATION INFORMATION for Safe Operating Area.
- This device series incorporates ESD protection (except OUT pin) and is tested by the following methods:  
 ESD Human Body Model tested per EIA/JESD22-A114  
 ESD Machine Model tested per EIA/JESD22-A115  
 Latchup Current Maximum Rating tested per JEDEC standard: JESD78.

## THERMAL CHARACTERISTICS

Rating	Symbol	Value	Unit
Thermal Characteristics, WDFN6 2 mm x 2 mm Thermal Resistance, Junction-to-Air (Note 3)	$R_{\theta JA}$	97	°C/W

- This data was derived by thermal simulations based on the JEDEC JESD51 series standards methodology. Only a single device mounted at the center of a high K (2s2p) 3 in x 3 in multilayer board with 1-ounce internal planes and 1-ounce copper on top and bottom. Top copper layer has a dedicated 25 sq mm copper area.

# NCP135

**ELECTRICAL CHARACTERISTICS VOLTAGE VERSION – 0.4 V**  $-40^{\circ}\text{C} \leq T_J \leq 125^{\circ}\text{C}$ ;  $V_{\text{BIAS}} = 2.7\text{ V}$  or  $(V_{\text{OUT}} + 1.6\text{ V})$ , whichever is greater,  $V_{\text{IN}} = V_{\text{OUT(NOM)}} + 0.3\text{ V}$ ,  $I_{\text{OUT}} = 1\text{ mA}$ ,  $V_{\text{EN}} = 1\text{ V}$ ,  $C_{\text{IN}} = 4.7\text{ }\mu\text{F}$ ,  $C_{\text{OUT}} = 10\text{ }\mu\text{F}$ ,  $C_{\text{BIAS}} = 1\text{ }\mu\text{F}$ , unless otherwise noted. Typical values are at  $T_J = +25^{\circ}\text{C}$ . Min/Max values are for  $-40^{\circ}\text{C} \leq T_J \leq 125^{\circ}\text{C}$  unless otherwise noted. (Note 4)

Parameter	Test Conditions	Symbol	Min	Typ	Max	Unit
Operating Input Voltage Range		$V_{\text{IN}}$	$V_{\text{OUT}} + V_{\text{DO}}$		5.5	V
Operating Bias Voltage Range		$V_{\text{BIAS}}$	$(V_{\text{OUT}} + 1.50) \geq 2.5$		5.5	V
Undervoltage Lock-out	$V_{\text{BIAS}}$ Rising Hysteresis	UVLO		1.6 0.2		V
Nominal Output Voltage	$T_J = +25^{\circ}\text{C}$	$V_{\text{OUT(NOM)}}$		0.400		V
Output Voltage Accuracy		$V_{\text{OUT}}$		$\pm 0.5$		%
Output Voltage Accuracy	$-40^{\circ}\text{C} \leq T_J \leq 125^{\circ}\text{C}$ , $V_{\text{OUT(NOM)}} + 0.3\text{ V} \leq V_{\text{IN}} \leq V_{\text{OUT(NOM)}} + 1.0\text{ V}$ , $2.7\text{ V}$ or $(V_{\text{OUT(NOM)}} + 1.6\text{ V})$ , whichever is greater < $V_{\text{BIAS}} < 5.5\text{ V}$ , $1\text{ mA} < I_{\text{OUT}} < 500\text{ mA}$	$V_{\text{OUT}}$	-1.0		+1.0	%
$V_{\text{IN}}$ Line Regulation	$V_{\text{OUT(NOM)}} + 0.3\text{ V} \leq V_{\text{IN}} \leq 5.0\text{ V}$	LineReg		0.01		%/V
$V_{\text{BIAS}}$ Line Regulation	$2.7\text{ V}$ or $(V_{\text{OUT(NOM)}} + 1.6\text{ V})$ , whichever is greater < $V_{\text{BIAS}} < 5.5\text{ V}$	LineReg		0.01		%/V
Load Regulation	$I_{\text{OUT}} = 1\text{ mA}$ to $500\text{ mA}$	LoadReg		0.5		mV
$V_{\text{IN}}$ Dropout Voltage	$I_{\text{OUT}} = 500\text{ mA}$ (Note 5)	$V_{\text{DO}}$		53	100	mV
Output Current Limit	$V_{\text{OUT}} = 90\% V_{\text{OUT(NOM)}}$	$I_{\text{CL}}$	600	820	1200	mA
SNS Pin Operating Current		$I_{\text{SNS}}$		0.01	0.5	$\mu\text{A}$
Bias Pin Quiescent Current	$V_{\text{BIAS}} = 2.7\text{ V}$ , $I_{\text{OUT}} = 0\text{ mA}$	$I_{\text{BIASQ}}$		35	55	$\mu\text{A}$
Bias Pin Disable Current	$V_{\text{EN}} \leq 0.4\text{ V}$	$I_{\text{BIAS(DIS)}}$		0.2	1	$\mu\text{A}$
Vinput Pin Disable Current	$V_{\text{EN}} \leq 0.4\text{ V}$	$I_{\text{VIN(DIS)}}$		0.01	1	$\mu\text{A}$
EN Pin Threshold Voltage	EN Input Voltage "H"	$V_{\text{EN(H)}}$	0.9			V
	EN Input Voltage "L"	$V_{\text{EN(L)}}$			0.4	
EN Pull Down Current	$V_{\text{EN}} = 5.5\text{ V}$	$I_{\text{EN}}$		0.3	1	$\mu\text{A}$
Turn-On Time	From assertion of $V_{\text{EN}}$ to $V_{\text{OUT}} = 98\% V_{\text{OUT(NOM)}}$	$t_{\text{ON}}$		150		$\mu\text{s}$
Power Supply Rejection Ratio	$V_{\text{IN}}$ to $V_{\text{OUT}}$ , $f = 1\text{ kHz}$ , $I_{\text{OUT}} = 10\text{ mA}$ , $V_{\text{IN}} \geq V_{\text{OUT}} + 0.5\text{ V}$	PSRR( $V_{\text{IN}}$ )		73		dB
	$V_{\text{BIAS}}$ to $V_{\text{OUT}}$ , $f = 1\text{ kHz}$ , $I_{\text{OUT}} = 10\text{ mA}$ , $V_{\text{IN}} \geq V_{\text{OUT}} + 0.5\text{ V}$	PSRR( $V_{\text{BIAS}}$ )		90		
Output Noise Voltage	$V_{\text{IN}} = V_{\text{OUT}} + 0.5\text{ V}$ , $f = 10\text{ Hz}$ to $100\text{ kHz}$	$V_{\text{N}}$		28.7		$\mu\text{V}_{\text{RMS}}$
Thermal Shutdown Threshold	Temperature increasing			160		$^{\circ}\text{C}$
	Temperature decreasing			140		
Output Discharge Pull-Down	$V_{\text{EN}} \leq 0.4\text{ V}$ , $V_{\text{OUT}} = 0.4\text{ V}$ , NCP135A options only	$R_{\text{DISCH}}$		150		$\Omega$

Product parametric performance is indicated in the Electrical Characteristics for the listed test conditions, unless otherwise noted. Product performance may not be indicated by the Electrical Characteristics if operated under different conditions.

- Performance guaranteed over the indicated operating temperature range by design and/or characterization. Production tested at  $T_A = 25^{\circ}\text{C}$ . Low duty cycle pulse techniques are used during the testing to maintain the junction temperature as close to ambient as possible.
- Dropout voltage is characterized when  $V_{\text{OUT}}$  falls 3% below  $V_{\text{OUT(NOM)}}$ .

# NCP135

**ELECTRICAL CHARACTERISTICS VOLTAGE VERSION – 0.75 V**  $-40^{\circ}\text{C} \leq T_J \leq 125^{\circ}\text{C}$ ;  $V_{\text{BIAS}} = 2.7\text{ V}$  or  $(V_{\text{OUT}} + 1.6\text{ V})$ , whichever is greater,  $V_{\text{IN}} = V_{\text{OUT(NOM)}} + 0.3\text{ V}$ ,  $I_{\text{OUT}} = 1\text{ mA}$ ,  $V_{\text{EN}} = 1\text{ V}$ ,  $C_{\text{IN}} = 4.7\text{ }\mu\text{F}$ ,  $C_{\text{OUT}} = 10\text{ }\mu\text{F}$ ,  $C_{\text{BIAS}} = 1\text{ }\mu\text{F}$ , unless otherwise noted. Typical values are at  $T_J = +25^{\circ}\text{C}$ . Min/Max values are for  $-40^{\circ}\text{C} \leq T_J \leq 125^{\circ}\text{C}$  unless otherwise noted. (Note 6)

Parameter	Test Conditions	Symbol	Min	Typ	Max	Unit
Operating Input Voltage Range		$V_{\text{IN}}$	$V_{\text{OUT}} + V_{\text{DO}}$		5.5	V
Operating Bias Voltage Range		$V_{\text{BIAS}}$	$(V_{\text{OUT}} + 1.50) \geq 2.5$		5.5	V
Undervoltage Lock-out	$V_{\text{BIAS}}$ Rising Hysteresis	UVLO		1.6 0.2		V
Nominal Output Voltage	$T_J = +25^{\circ}\text{C}$	$V_{\text{OUT(NOM)}}$		0.750		V
Output Voltage Accuracy		$V_{\text{OUT}}$		$\pm 0.5$		%
Output Voltage Accuracy	$-40^{\circ}\text{C} \leq T_J \leq 125^{\circ}\text{C}$ , $V_{\text{OUT(NOM)}} + 0.3\text{ V} \leq V_{\text{IN}} \leq V_{\text{OUT(NOM)}} + 1.0\text{ V}$ , $2.7\text{ V}$ or $(V_{\text{OUT(NOM)}} + 1.6\text{ V})$ , whichever is greater < $V_{\text{BIAS}} < 5.5\text{ V}$ , $1\text{ mA} < I_{\text{OUT}} < 500\text{ mA}$	$V_{\text{OUT}}$	-1.0		+1.0	%
$V_{\text{IN}}$ Line Regulation	$V_{\text{OUT(NOM)}} + 0.3\text{ V} \leq V_{\text{IN}} \leq 5.0\text{ V}$	LineReg		0.01		%/V
$V_{\text{BIAS}}$ Line Regulation	$2.7\text{ V}$ or $(V_{\text{OUT(NOM)}} + 1.6\text{ V})$ , whichever is greater < $V_{\text{BIAS}} < 5.5\text{ V}$	LineReg		0.01		%/V
Load Regulation	$I_{\text{OUT}} = 1\text{ mA}$ to $500\text{ mA}$	LoadReg		0.5		mV
$V_{\text{IN}}$ Dropout Voltage	$I_{\text{OUT}} = 500\text{ mA}$ (Note 7)	$V_{\text{DO}}$		52	100	mV
Output Current Limit	$V_{\text{OUT}} = 90\% V_{\text{OUT(NOM)}}$	$I_{\text{CL}}$	600	820	1200	mA
SNS Pin Operating Current		$I_{\text{SNS}}$		0.01	0.5	$\mu\text{A}$
Bias Pin Quiescent Current	$V_{\text{BIAS}} = 2.7\text{ V}$ , $I_{\text{OUT}} = 0\text{ mA}$	$I_{\text{BIASQ}}$		35	55	$\mu\text{A}$
Bias Pin Disable Current	$V_{\text{EN}} \leq 0.4\text{ V}$	$I_{\text{BIAS(DIS)}}$		0.2	1	$\mu\text{A}$
Vinput Pin Disable Current	$V_{\text{EN}} \leq 0.4\text{ V}$	$I_{\text{VIN(DIS)}}$		0.01	1	$\mu\text{A}$
EN Pin Threshold Voltage	EN Input Voltage "H"	$V_{\text{EN(H)}}$	0.9			V
	EN Input Voltage "L"	$V_{\text{EN(L)}}$			0.4	
EN Pull Down Current	$V_{\text{EN}} = 5.5\text{ V}$	$I_{\text{EN}}$		0.3	1	$\mu\text{A}$
Turn-On Time	From assertion of $V_{\text{EN}}$ to $V_{\text{OUT}} = 98\% V_{\text{OUT(NOM)}}$	$t_{\text{ON}}$		198		$\mu\text{s}$
Power Supply Rejection Ratio	$V_{\text{IN}}$ to $V_{\text{OUT}}$ , $f = 1\text{ kHz}$ , $I_{\text{OUT}} = 10\text{ mA}$ , $V_{\text{IN}} \geq V_{\text{OUT}} + 0.5\text{ V}$	PSRR( $V_{\text{IN}}$ )		73		dB
	$V_{\text{BIAS}}$ to $V_{\text{OUT}}$ , $f = 1\text{ kHz}$ , $I_{\text{OUT}} = 10\text{ mA}$ , $V_{\text{IN}} \geq V_{\text{OUT}} + 0.5\text{ V}$	PSRR( $V_{\text{BIAS}}$ )		100		
Output Noise Voltage	$V_{\text{IN}} = V_{\text{OUT}} + 0.5\text{ V}$ , $f = 10\text{ Hz}$ to $100\text{ kHz}$	$V_{\text{N}}$		35.3		$\mu\text{V}_{\text{RMS}}$
Thermal Shutdown Threshold	Temperature increasing			160		$^{\circ}\text{C}$
	Temperature decreasing			140		
Output Discharge Pull-Down	$V_{\text{EN}} \leq 0.4\text{ V}$ , $V_{\text{OUT}} = 0.4\text{ V}$ , NCP135A options only	$R_{\text{DISCH}}$		150		$\Omega$

Product parametric performance is indicated in the Electrical Characteristics for the listed test conditions, unless otherwise noted. Product performance may not be indicated by the Electrical Characteristics if operated under different conditions.

6. Performance guaranteed over the indicated operating temperature range by design and/or characterization. Production tested at  $T_A = 25^{\circ}\text{C}$ . Low duty cycle pulse techniques are used during the testing to maintain the junction temperature as close to ambient as possible.
7. Dropout voltage is characterized when  $V_{\text{OUT}}$  falls 3% below  $V_{\text{OUT(NOM)}}$ .

TYPICAL CHARACTERISTICS

At  $T_J = +25^\circ\text{C}$ ,  $V_{IN} = V_{OUT(NOM)} + 0.3\text{ V}$ ,  $V_{BIAS} = 2.7\text{ V}$ ,  $V_{EN} = 1.0\text{ V}$ ,  $V_{OUT(NOM)} = 0.4\text{ V}$ ,  $I_{OUT} = 500\text{ mA}$ ,  $C_{IN} = 1\text{ }\mu\text{F}$ ,  $C_{BIAS} = 0.1\text{ }\mu\text{F}$ , and  $C_{OUT} = 10\text{ }\mu\text{F}$  (effective capacitance value), unless otherwise noted.

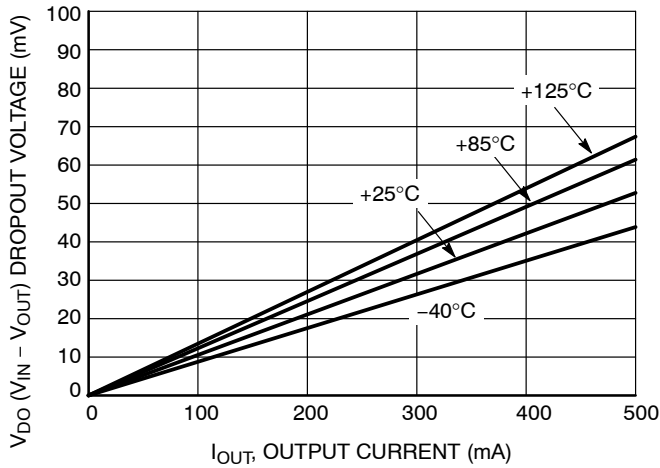

Figure 3.  $V_{IN}$  Dropout Voltage vs.  $I_{OUT}$  and Temperature  $T_J$

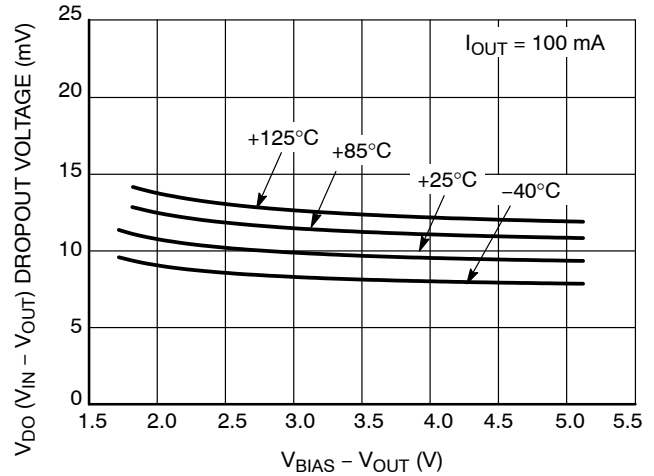

Figure 4.  $V_{IN}$  Dropout Voltage vs.  $(V_{BIAS} - V_{OUT})$  and Temperature  $T_J$

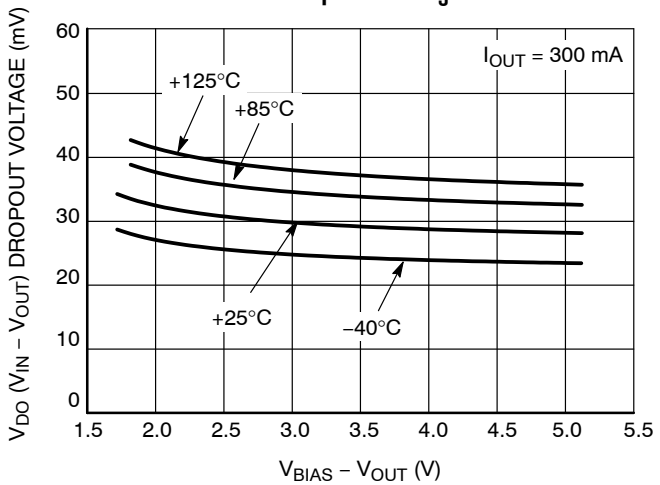

Figure 5.  $V_{IN}$  Dropout Voltage vs.  $(V_{BIAS} - V_{OUT})$  and Temperature  $T_J$

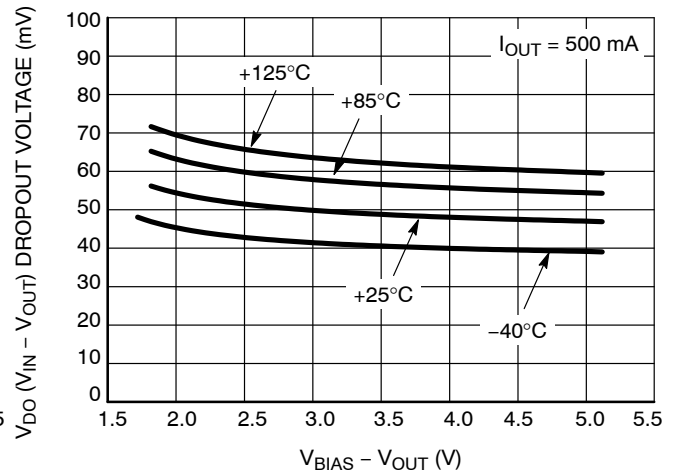

Figure 6.  $V_{IN}$  Dropout Voltage vs.  $(V_{BIAS} - V_{OUT})$  and Temperature  $T_J$

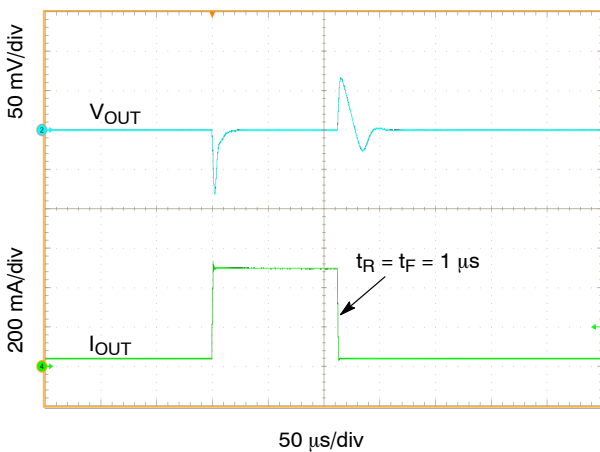

Figure 7. Load Transient Response,  $I_{OUT} = 50\text{ mA}$  to  $500\text{ mA}$ ,  $C_{OUT} = 10\text{ }\mu\text{F}$

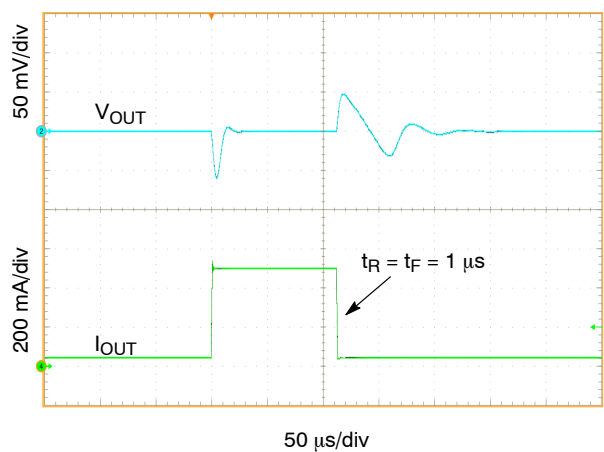

Figure 8. Load Transient Response,  $I_{OUT} = 50\text{ mA}$  to  $500\text{ mA}$ ,  $C_{OUT} = 22\text{ }\mu\text{F}$

TYPICAL CHARACTERISTICS

At  $T_J = +25^\circ\text{C}$ ,  $V_{IN} = V_{OUT(NOM)} + 0.3\text{ V}$ ,  $V_{BIAS} = 2.7\text{ V}$ ,  $V_{EN} = 1.0\text{ V}$ ,  $V_{OUT(NOM)} = 0.4\text{ V}$ ,  $I_{OUT} = 500\text{ mA}$ ,  $C_{IN} = 1\text{ }\mu\text{F}$ ,  $C_{BIAS} = 0.1\text{ }\mu\text{F}$ , and  $C_{OUT} = 10\text{ }\mu\text{F}$  (effective capacitance value), unless otherwise noted.

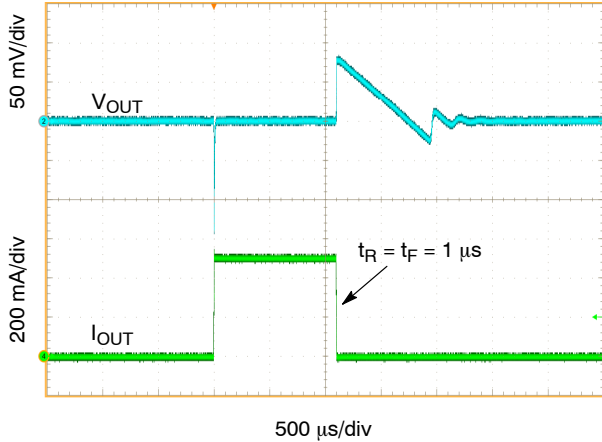

Figure 9. Load Transient Response,  $I_{OUT} = 1\text{ mA}$  to  $500\text{ mA}$ ,  $C_{OUT} = 10\text{ }\mu\text{F}$

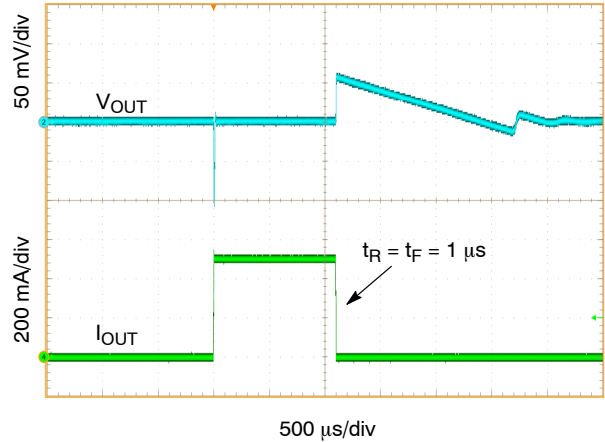

Figure 10. Load Transient Response,  $I_{OUT} = 1\text{ mA}$  to  $500\text{ mA}$ ,  $C_{OUT} = 22\text{ }\mu\text{F}$

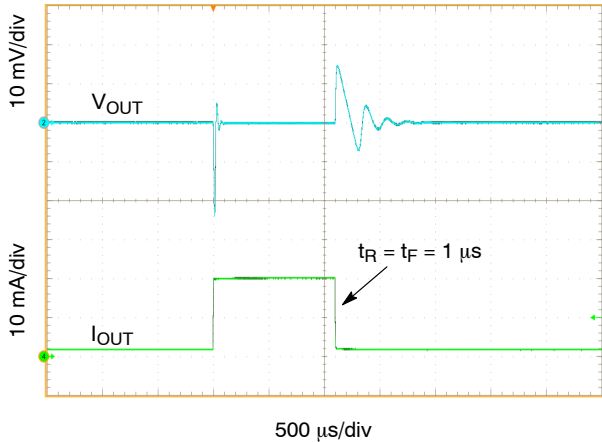

Figure 11. Load Transient Response,  $I_{OUT} = 1\text{ mA}$  to  $20\text{ mA}$ ,  $C_{OUT} = 10\text{ }\mu\text{F}$

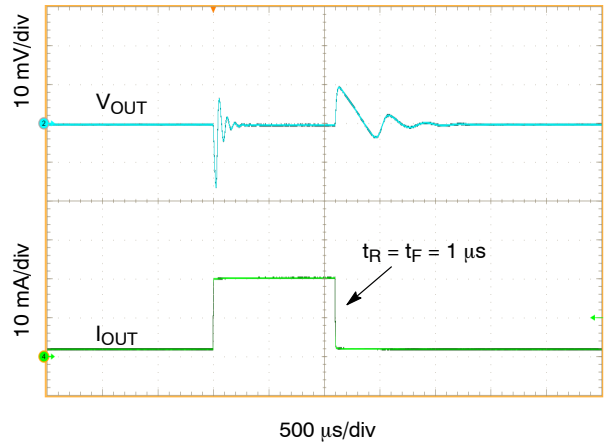

Figure 12. Load Transient Response,  $I_{OUT} = 1\text{ mA}$  to  $20\text{ mA}$ ,  $C_{OUT} = 22\text{ }\mu\text{F}$

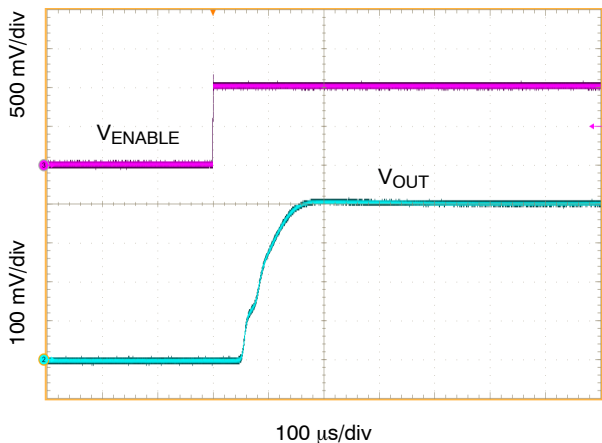

Figure 13. Enable Transient Response,  $I_{OUT} = 0\text{ mA}$ ,  $C_{OUT} = 10\text{ }\mu\text{F}$

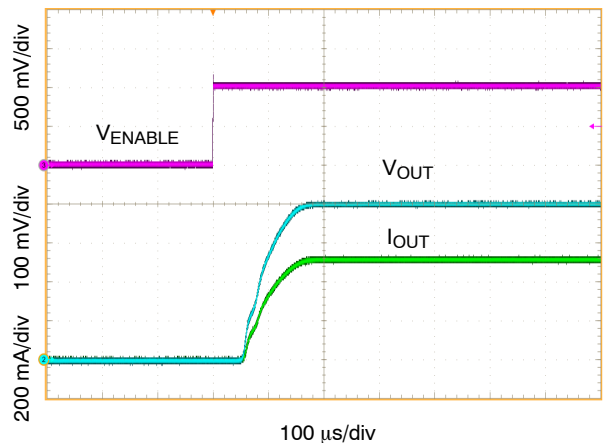
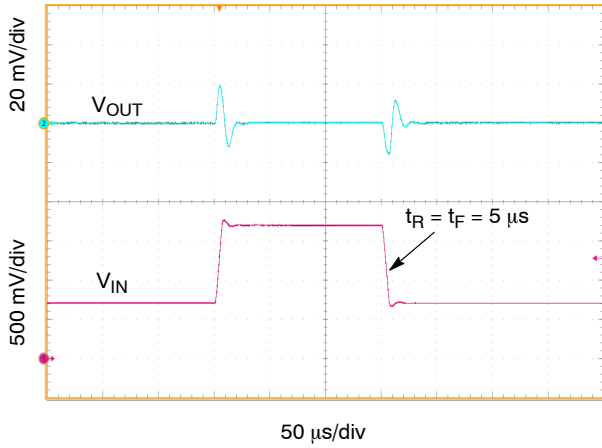

Figure 14. Enable Transient Response, Output Resistive Load  $500\text{ mA}$ ,  $C_{OUT} = 22\text{ }\mu\text{F}$

# NCP135

## TYPICAL CHARACTERISTICS

At  $T_J = +25^\circ\text{C}$ ,  $V_{IN} = V_{OUT(NOM)} + 0.3\text{ V}$ ,  $V_{BIAS} = 2.7\text{ V}$ ,  $V_{EN} = 1.0\text{ V}$ ,  $V_{OUT(NOM)} = 0.4\text{ V}$ ,  $I_{OUT} = 500\text{ mA}$ ,  $C_{IN} = 1\text{ }\mu\text{F}$ ,  $C_{BIAS} = 0.1\text{ }\mu\text{F}$ , and  $C_{OUT} = 10\text{ }\mu\text{F}$  (effective capacitance value), unless otherwise noted.



**Figure 15.  $V_{IN}$  Line Transient Response,**  
 $V_{IN} = 0.7\text{ V to }1.7\text{ V}$ ,  $I_{OUT} = 100\text{ mA}$ ,  $C_{IN} = 0$ ,  
 $C_{OUT} = 10\text{ }\mu\text{F}$

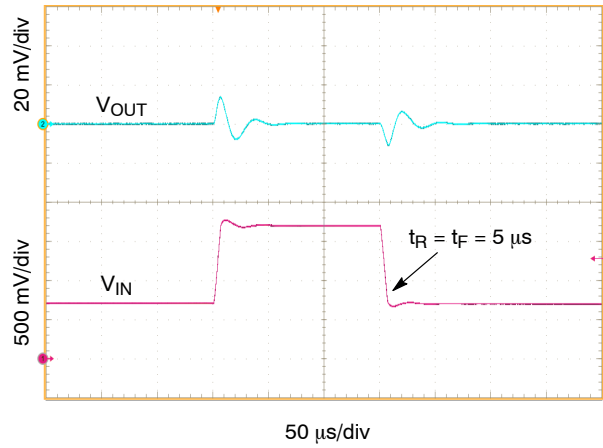

**Figure 16.  $V_{IN}$  Line Transient Response,**  
 $V_{IN} = 0.7\text{ V to }1.7\text{ V}$ ,  $I_{OUT} = 100\text{ mA}$ ,  $C_{IN} = 0$ ,  
 $C_{OUT} = 22\text{ }\mu\text{F}$

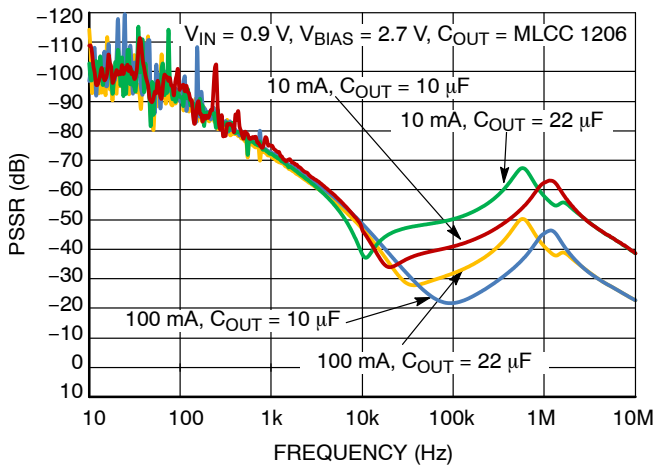

**Figure 17.  $V_{IN}$  Power Supply Rejection Ratio vs. Frequency**

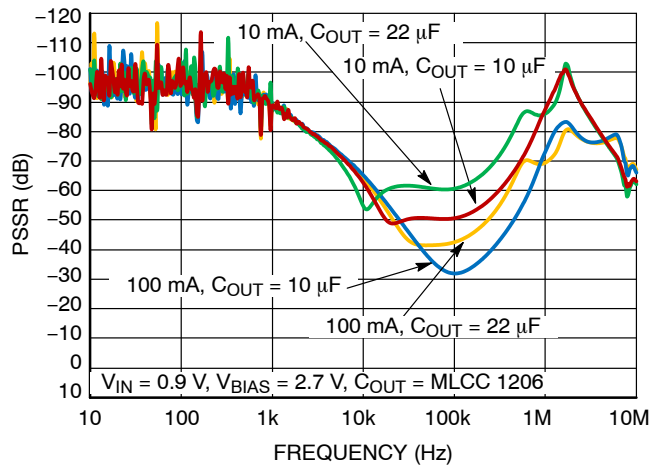

**Figure 18.  $V_{BIAS}$  Power Supply Rejection Ratio vs. Frequency**



# NCP135

## TYPICAL CHARACTERISTICS

At  $T_J = +25^\circ\text{C}$ ,  $V_{IN} = V_{OUT(NOM)} + 0.3\text{ V}$ ,  $V_{BIAS} = 2.7\text{ V}$ ,  $V_{EN} = 1.0\text{ V}$ ,  $V_{OUT(NOM)} = 0.4\text{ V}$ ,  $I_{OUT} = 500\text{ mA}$ ,  $C_{IN} = 1\text{ }\mu\text{F}$ ,  $C_{BIAS} = 0.1\text{ }\mu\text{F}$ , and  $C_{OUT} = 10\text{ }\mu\text{F}$  (effective capacitance value), unless otherwise noted.

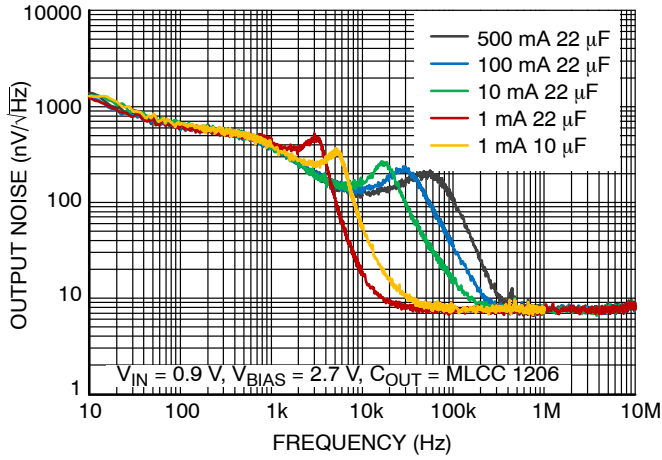

**Figure 19. Output Voltage Noise Spectral Density at NCP135AMT040TBG**

		RMS Output Noise Voltage ( $\mu\text{V}$ )	
$I_{OUT}$	$C_{OUT}$	10 Hz – 100 kHz	100 Hz – 100 kHz
1 mA	10 $\mu\text{F}$	28.67	27.54
1 mA	22 $\mu\text{F}$	28.19	27.28
10 mA	22 $\mu\text{F}$	36.23	35.49
100 mA	22 $\mu\text{F}$	45.44	44.87
500 mA	22 $\mu\text{F}$	54.54	54.04

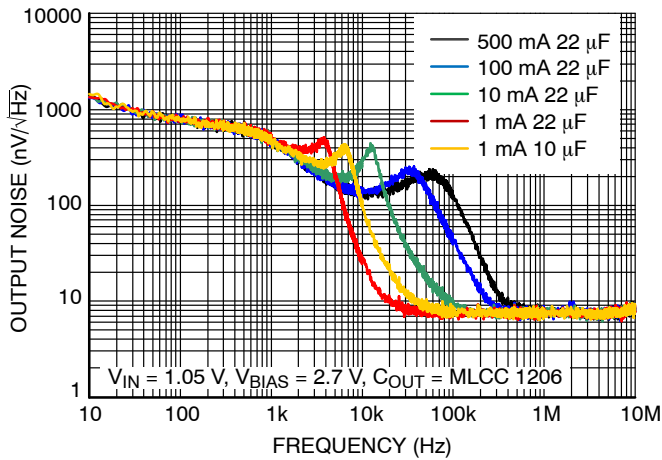

**Figure 20. Output Voltage Noise Spectral Density at NCP135AMT075TBG**

		RMS Output Noise Voltage ( $\mu\text{V}$ )	
$I_{OUT}$	$C_{OUT}$	10 Hz – 100 kHz	100 Hz – 100 kHz
1 mA	10 $\mu\text{F}$	35.34	34.22
1 mA	22 $\mu\text{F}$	33.39	32.22
10 mA	22 $\mu\text{F}$	41.85	40.91
100 mA	22 $\mu\text{F}$	51.70	50.98
500 mA	22 $\mu\text{F}$	59.78	59.16

# NCP135

## APPLICATIONS INFORMATION

The NCP135 dual-rail very low dropout voltage regulator is using NMOS pass transistor for output voltage regulation from  $V_{IN}$  voltage. All the low current internal control circuitry is powered from the  $V_{BIAS}$  voltage.

The use of an NMOS pass transistor offers several advantages in applications. Unlike PMOS topology devices, the output capacitor has reduced impact on loop stability.  $V_{IN}$  to  $V_{OUT}$  operating voltage difference can be very low compared with standard PMOS regulators in very low  $V_{in}$  applications.

When enabled from Enable (EN) input, the NCP135 offers smooth monotonic start-up. The controlled voltage rising limits the inrush current.

The Enable (EN) input is equipped with internal hysteresis.

### Dropout Voltage

The  $V_{IN}$  Dropout voltage is the voltage difference ( $V_{IN} - V_{OUT}$ ) when  $V_{OUT}$  starts to decrease by percent specified in the Electrical Characteristics table with the  $V_{IN}$  voltage decreasing.  $V_{BIAS}$  is high enough; specific value is published in the Electrical Characteristics table.

### Input and Output Capacitors

The device is designed to be stable for ceramic output capacitors with Effective capacitance in the range from 10  $\mu\text{F}$  to 22  $\mu\text{F}$ . The device is also stable with multiple capacitors in parallel, having the total effective capacitance in the specified range.

In applications where no low input supplies impedance available (PCB inductance in  $V_{IN}$  and/or  $V_{BIAS}$  inputs as example), the recommended  $C_{IN} = 1 \mu\text{F}$  and  $C_{BIAS} = 0.1 \mu\text{F}$  or greater. Ceramic capacitors are recommended. For the best performance all the capacitors should be connected to the NCP135 respective pins directly in the device PCB

copper layer, not through vias having not negligible impedance.

When using small ceramic capacitor, their capacitance is not constant but varies with applied DC biasing voltage, temperature and tolerance. The effective capacitance can be much lower than their nominal capacitance value, most importantly in negative temperatures and higher LDO output voltages. That is why the recommended Output capacitor capacitance value is specified as Effective value in the specific application conditions.

### Enable Operation

The enable pin will turn the regulator on or off. The threshold limits are covered in the electrical characteristics table in this data sheet. If the enable function is not to be used then the pin should be connected to  $V_{IN}$  or  $V_{BIAS}$ .

### Current Limitation

The internal Current Limitation circuitry allows the device to supply the full nominal current and surges but protects the device against Current Overload or Short.

### Thermal Protection

Internal thermal shutdown (TSD) circuitry is provided to protect the integrated circuit in the event that the maximum junction temperature is exceeded. When TSD activated, the regulator output turns off. When cooling down under the low temperature threshold, device output is activated again. This TSD feature is provided to prevent failures from accidental overheating.

Activation of the thermal protection circuit indicates excessive power dissipation or inadequate heatsinking. For reliable operation, junction temperature should be limited to +125°C maximum.

## ORDERING INFORMATION

Device	Marking	Option	Package	Shipping†
NCP135AMT040TBG	KA	Output Active Discharge	WDFN6 (Pb-Free)	3000 / Tape & Reel
NCP135BMT040TBG	KC	Non-Active Discharge		
NCP135AMT075TBG	KG	Output Active Discharge		

†For information on tape and reel specifications, including part orientation and tape sizes, please refer to our Tape and Reel Packaging Specifications Brochure, BRD8011/D.

To order other package and voltage variants, please contact your ON Semiconductor sales representative

# MECHANICAL CASE OUTLINE PACKAGE DIMENSIONS

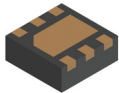

WDFN6 2x2, 0.65P  
CASE 511BR  
ISSUE C

DATE 01 DEC 2021

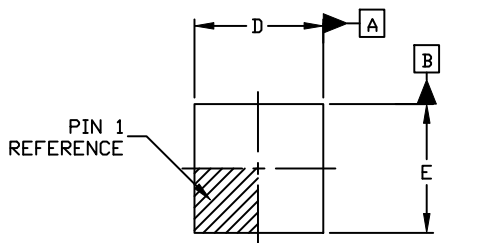

TOP VIEW

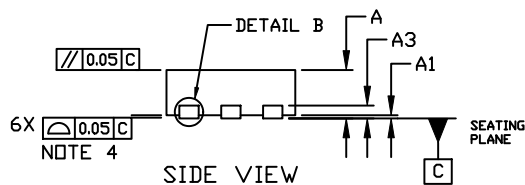

SIDE VIEW

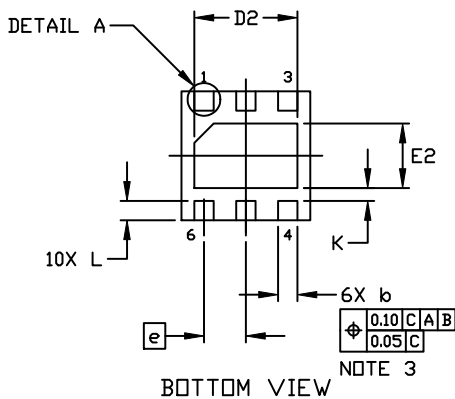

BOTTOM VIEW

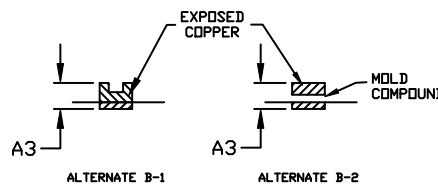

DETAIL B  
ALTERNATE CONSTRUCTION

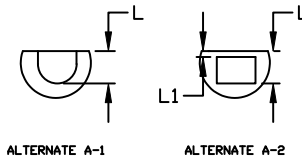

DETAIL A  
ALTERNATE CONSTRUCTIONS

DIM	MILLIMETERS		
	MIN.	NDM.	MAX.
A	0.70	0.75	0.80
A1	0.00	---	0.05
A3	0.20 REF		
b	0.25	0.30	0.35
D	1.90	2.00	2.10
D2	1.50	1.60	1.70
E	1.90	2.00	2.10
E2	0.90	1.00	1.10
e	0.65 BSC		
K	0.20 REF		
L	0.20	0.30	0.40
L1	---	---	0.15

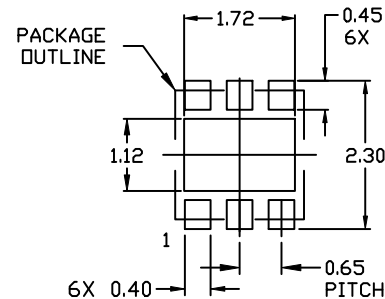

RECOMMENDED  
MOUNTING FOOTPRINT

For additional information on our Pb-Free strategy and soldering details, please download the ON Semiconductor Soldering and Mounting Techniques Reference Manual, SOLDERM/D.

### GENERIC MARKING DIAGRAM\*



XX = Specific Device Code  
M = Date Code

\*This information is generic. Please refer to device data sheet for actual part marking. Pb-Free indicator, "G" or microdot "\*", may or may not be present. Some products may not follow the Generic Marking.

DOCUMENT NUMBER:	98AON55829E	Electronic versions are uncontrolled except when accessed directly from the Document Repository. Printed versions are uncontrolled except when stamped "CONTROLLED COPY" in red.
DESCRIPTION:	WDFN6 2X2, 0.65P	PAGE 1 OF 1

onsemi and ONSEMI are trademarks of Semiconductor Components Industries, LLC dba onsemi or its subsidiaries in the United States and/or other countries. onsemi reserves the right to make changes without further notice to any products herein. onsemi makes no warranty, representation or guarantee regarding the suitability of its products for any particular purpose, nor does onsemi assume any liability arising out of the application or use of any product or circuit, and specifically disclaims any and all liability, including without limitation special, consequential or incidental damages. onsemi does not convey any license under its patent rights nor the rights of others.

**onsemi**, **Onsemi**, and other names, marks, and brands are registered and/or common law trademarks of Semiconductor Components Industries, LLC dba "**onsemi**" or its affiliates and/or subsidiaries in the United States and/or other countries. **onsemi** owns the rights to a number of patents, trademarks, copyrights, trade secrets, and other intellectual property. A listing of **onsemi**'s product/patent coverage may be accessed at [www.onsemi.com/site/pdf/Patent-Marking.pdf](http://www.onsemi.com/site/pdf/Patent-Marking.pdf). **onsemi** reserves the right to make changes at any time to any products or information herein, without notice. The information herein is provided "as-is" and **onsemi** makes no warranty, representation or guarantee regarding the accuracy of the information, product features, availability, functionality, or suitability of its products for any particular purpose, nor does **onsemi** assume any liability arising out of the application or use of any product or circuit, and specifically disclaims any and all liability, including without limitation special, consequential or incidental damages. Buyer is responsible for its products and applications using **onsemi** products, including compliance with all laws, regulations and safety requirements or standards, regardless of any support or applications information provided by **onsemi**. "Typical" parameters which may be provided in **onsemi** data sheets and/or specifications can and do vary in different applications and actual performance may vary over time. All operating parameters, including "Typicals" must be validated for each customer application by customer's technical experts. **onsemi** does not convey any license under any of its intellectual property rights nor the rights of others. **onsemi** products are not designed, intended, or authorized for use as a critical component in life support systems or any FDA Class 3 medical devices or medical devices with a same or similar classification in a foreign jurisdiction or any devices intended for implantation in the human body. Should Buyer purchase or use **onsemi** products for any such unintended or unauthorized application, Buyer shall indemnify and hold **onsemi** and its officers, employees, subsidiaries, affiliates, and distributors harmless against all claims, costs, damages, and expenses, and reasonable attorney fees arising out of, directly or indirectly, any claim of personal injury or death associated with such unintended or unauthorized use, even if such claim alleges that **onsemi** was negligent regarding the design or manufacture of the part. **onsemi** is an Equal Opportunity/Affirmative Action Employer. This literature is subject to all applicable copyright laws and is not for resale in any manner.

## PUBLICATION ORDERING INFORMATION

### LITERATURE FULFILLMENT:

Email Requests to: [orderlit@onsemi.com](mailto:orderlit@onsemi.com)

**onsemi Website:** [www.onsemi.com](http://www.onsemi.com)

### TECHNICAL SUPPORT

**North American Technical Support:**

Voice Mail: 1 800-282-9855 Toll Free USA/Canada

Phone: 011 421 33 790 2910

**Europe, Middle East and Africa Technical Support:**

Phone: 00421 33 790 2910

For additional information, please contact your local Sales Representative