

CHIP COILS (CHIP INDUCTORS) LQM2HPN□□□□GH□ REFERENCE SPECIFICATION

1. Scope

This reference specification applies to chip coils (chip inductors) LQM2HPN_GH series for general electronic equipment.

2. Part Numbering

(Ex.)

| LQ | M | 2H | P | N | 1R0 | M | G | H | L |
|------------|-----------|----------------------|-----------------------------------|----------|------------|-----------|------------------|-------|------------------------------------|
| Product ID | Structure | Dimension (L × W) | Application and characteristic | Category | Inductance | Tolerance | Dimension (T) | Other | Packaging L: taping *B: bulk |

*B: Bulk packing is also available.

3. Part Number and Rating

| | |
|-----------------------------|----------------|
| Operating temperature range | -40°C to +85°C |
| Storage temperature range | -40°C to +85°C |

| Customer Part number | Murata Part number | Inductance | | DC resistance (mΩ) | | Self-resonant frequency (MHz min.) | Rated current (A) ^{*3} | | | |
|-------------------------|-----------------------|--------------------------|------------------|--------------------------|------|--|--|------|---|------|
| | | Nominal value (μH) | Tolerance (%) | Typ. | Max. | | Based on inductance change ^{*1} | | Based on temperature rise ^{*2} | |
| | | | | | | | Typ. | Max. | Typ. | Max. |
| | LQM2HPNR24MGHL | 0.24 | ±20 | 24 | 30 | 80 | 5.7 | 4.5 | 4.2 | 3.3 |
| | LQM2HPNR33MGHL | 0.33 | ±20 | 30 | 38 | 80 | 5.3 | 5.0 | 4.0 | 3.0 |
| | LQM2HPNR47MGHL | 0.47 | ±20 | 40 | 50 | 80 | 4.8 | 4.5 | 3.3 | 2.6 |
| | LQM2HPNR68MGHL | 0.68 | ±20 | 50 | 63 | 60 | 4.0 | 3.8 | 2.9 | 2.3 |
| | LQM2HPN1R0MGHL | 1.0 | ±20 | 50 | 63 | 50 | 2.3 | 2.0 | 2.9 | 2.3 |
| | LQM2HPN1R5MGHL | 1.5 | ±20 | 65 | 81 | 40 | 1.6 | 1.5 | 2.6 | 2.0 |
| | LQM2HPN2R2MGHL | 2.2 | ±20 | 110 | 138 | 30 | 1.6 | 1.5 | 1.9 | 1.5 |

*1 When rated current is applied to the products, inductance will be within ±30% of initial inductance value range.

*2 When rated current is applied to the products, temperature rise caused by self-generated heat shall be limited to 40°C max.

*3 Keep the temperature (ambient temperature plus self-generation of heat) under 125°C.

4. Testing Conditions

| | |
|----------------------------|---|
| Unless otherwise specified | Temperature: ordinary temperature (15°C to 35°C) Humidity: ordinary humidity [25% to 85% (RH)] |
| In case of doubt | Temperature: 20°C±2°C Humidity: 60% to 70% (RH) Atmospheric pressure: 86 kPa to 106 kPa |

5. Appearance and Dimensions

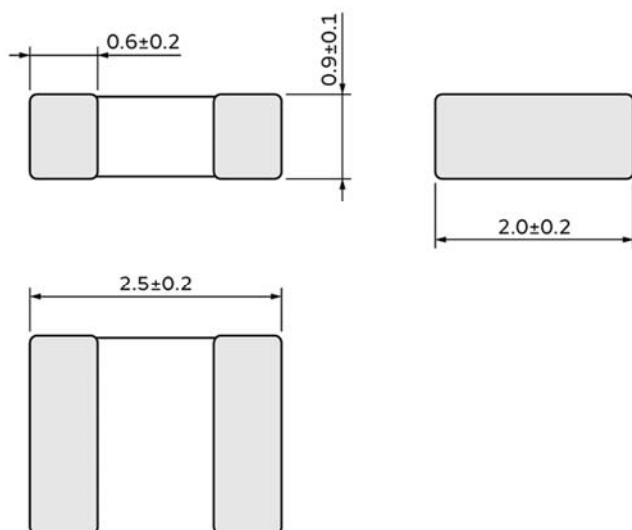

(in mm)

Unit mass (typical value): 0.022 g

6. Marking

No marking.

7. Electrical Performance

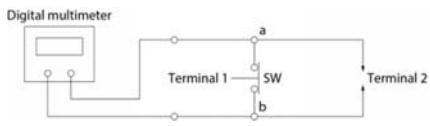
| No. | Item | Specification | Test method |
|-----|-------------------------|-------------------------|---|
| 7.1 | Inductance | Meet chapter 3 ratings. | Measuring equipment: Keysight 4294A or the equivalent (1 mA) Measuring frequency: 1 MHz |
| 7.2 | DC resistance | Meet chapter 3 ratings. | Measuring equipment: digital multimeter Measuring circuit:  <p>Measure with the product set to terminal 2 and the switch pressed (open between a and b). When setting or removing the product, press the switch to short between a and b.</p> |
| 7.3 | Self-resonant frequency | Meet chapter 3 ratings. | Measuring equipment: Keysight 4294A or the equivalent |

8. Mechanical Performance

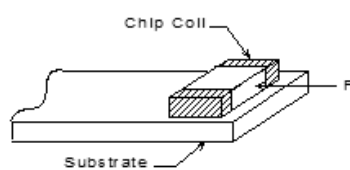
| No. | Item | Specification | Test method |
|-----|------------|---|--|
| 8.1 | Shear test | No significant mechanical damage or no sign of electrode peeling off shall be observed. | Force application direction:  <p>Applying force: 10 N Holding time: 5 s ± 1 s</p> |

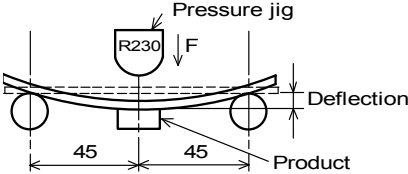
| No. | Item | Specification | Test method |
|-----|------------------------------|--|--|
| 8.2 | Bending test | No significant mechanical damage or no sign of electrode peeling off shall be observed. | <p>Test substrate: glass-epoxy substrate (100 mm × 40 mm × 1.0 mm) Pressurizing speed: 0.5 mm/s Deflection: 2 mm Holding time: 30 s</p>  |
| 8.3 | Vibration | Appearance shall have no significant mechanical damage. | <p>Oscillation frequency: 10 Hz to 2000 Hz to 10 Hz, for approx. 20 min Total amplitude: total amplitude of 3.0 mm or acceleration amplitude of 245 m/s², whichever is smaller Test time: 3 directions perpendicular to each other, 4 h for each direction (12 h in total)</p> |
| 8.4 | Drop | Appearance shall have no significant mechanical damage. | <p>The product shall be dropped so that it falls freely onto concrete or a steel board. Height: 1 m Number of falls: 10 times</p> |
| 8.5 | Solderability | 90% or more of the outer electrode shall be covered with new solder seamlessly. | <p>Flux: immersed in ethanol solution with a rosin content of 25(wt)% for 5 s to 10 s Solder: Sn-3.0Ag-0.5Cu solder Pre-heating: 150°C±10°C/60 s to 90 s Solder temperature: 240°C±5°C Immersion time: 3 s±1 s</p> |
| 8.6 | Resistance to soldering heat | Appearance: No significant mechanical damage shall be observed. Inductance change rate: within ±30% | <p>Flux: immersed in ethanol solution with a rosin content of 25(wt)% for 5 s to 10 s Solder: Sn-3.0Ag-0.5Cu solder Pre-heating: 150°C±10°C/60 s to 90 s Solder temperature: 270°C±5°C Immersion time: 10 s±1 s Post-treatment: left at a room temperature for 24 h±2 h</p> |

9. Environmental Performance

The product is soldered on a substrate for test.

| No. | Item | Specification | Test method |
|-----|-------------------|--|---|
| 9.1 | Heat resistance | Appearance: No significant mechanical damage shall be observed. Inductance change rate: within ±30% | <p>Temperature: 85°C±2°C Test time: 1000 h (+48 h, -0 h) Post-treatment: left at a room temperature for 24 h±2 h</p> |
| 9.2 | Cold resistance | Appearance: No significant mechanical damage shall be observed. Inductance change rate: within ±30% | <p>Temperature: -40°C±2°C Test time: 1000 h (+48 h, -0 h) Post-treatment: left at a room temperature for 24 h±2 h</p> |
| 9.3 | Humidity | Appearance: No significant mechanical damage shall be observed. Inductance change rate: within ±30% | <p>Temperature: 70°C±2°C Humidity: 90% (RH) to 95% (RH) Test time: 1000 h (+48 h, -0 h) Post-treatment: left at a room temperature for 24 h±2 h</p> |
| 9.4 | Temperature cycle | Appearance: No significant mechanical damage shall be observed. Inductance change rate: within ±30% | <p>Single cycle conditions: Step 1: -40°C±2°C/30 min±3 min Step 2: ordinary temperature/10 min to 15 min Step 3: +85°C±2°C/30 min±3 min Step 4: ordinary temperature/10 min to 15 min Number of testing: 100 cycles Post-treatment: left at a room temperature for 24 h±2 h</p> |

10. Specification of Packaging

10.1 Appearance and dimensions of tape (8 mm width/plastic tape)

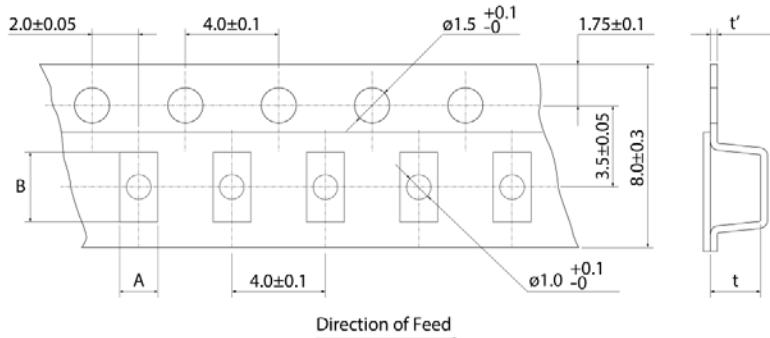

| | |
|----|-----------|
| A | 2.3±0.1 |
| B | 2.8±0.1 |
| t | 1.1±0.1 |
| t' | 0.25±0.05 |

(in mm)

* The dimensions of the cavity are measured at its bottom.

10.2 Taping specifications

| | |
|--------------------------------------|--|
| Packing quantity (Standard quantity) | 3000 pcs/reel |
| Packing method | The products are placed in embossed cavities of a plastic tape and sealed by a cover tape. |
| Feed hole position | The feed holes on the plastic tape are on the right side when the cover tape is pulled toward the user. |
| Joint | The plastic tape and the cover tape are seamless. |
| Number of missing products | Number of missing products within 0.1% of the number per reel or 1 pc., whichever is greater, and are not continuous. The specified quantity per reel is kept. |

10.3 Break down force of tape

| | |
|----------------------------------|-----------|
| Break down force of plastic tape | 10 N min. |
| Break down force of cover tape | 5 N min. |

10.4 Peeling off force of cover tape

| | |
|----------------------|--|
| Speed of peeling off | 300 mm/min |
| Peeling off force | 0.1 N to 0.7 N (The lower limit is for typical value.) |

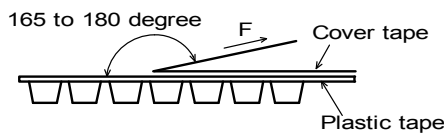

10.5 Dimensions of leader section, trailer section and reel

A vacant section is provided in the leader (start) section and trailer (end) section of the tape for the product. The leader section is further provided with an area consisting only of the cover tape. (See the diagram below.)

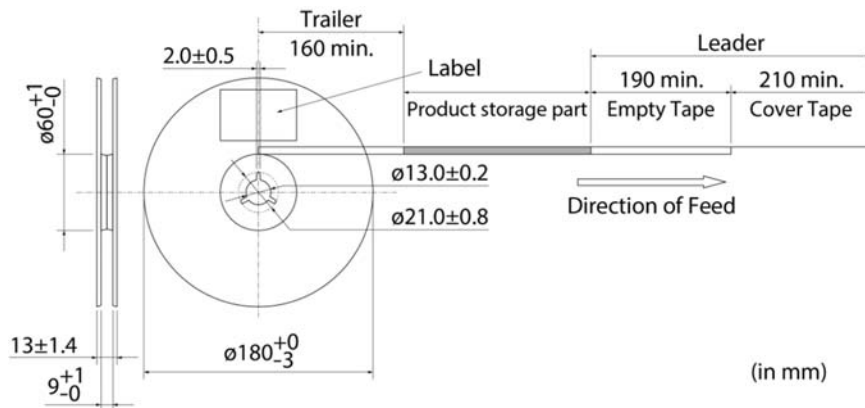

(in mm)

10.6 Marking for reel

Customer part number, Murata part number, inspection number (*1), RoHS marking (*2), quantity, etc.

| | | | | | | | |
|---|-------|------|------|-----|-----|-----|---|
| <p>*1 Expression of inspection No.:</p> <table style="width: 100%; text-align: center; border-collapse: collapse;"> <tr> <td style="border: 1px solid black; padding: 2px;">□□</td> <td style="border: 1px solid black; padding: 2px;">○○○○</td> <td style="border: 1px solid black; padding: 2px;">◇◇◇◇</td> </tr> <tr> <td style="border: 1px solid black; padding: 2px;">(1)</td> <td style="border: 1px solid black; padding: 2px;">(2)</td> <td style="border: 1px solid black; padding: 2px;">(3)</td> </tr> </table> | □□ | ○○○○ | ◇◇◇◇ | (1) | (2) | (3) | <p>(1) Factory code (2) Date First digit: year/last digit of year Second digit: month/Jan. to Sep.→1 to 9, Oct. to Dec.→O, N, D Third, Fourth digit: day (3) Serial No.</p> |
| □□ | ○○○○ | ◇◇◇◇ | | | | | |
| (1) | (2) | (3) | | | | | |
| <p>*2 Expression of RoHS marking:</p> <table style="width: 100%; text-align: center; border-collapse: collapse;"> <tr> <td style="border: 1px solid black; padding: 2px;">ROHS-</td> <td style="border: 1px solid black; padding: 2px;">Y</td> <td style="border: 1px solid black; padding: 2px;">(△)</td> </tr> <tr> <td style="border: 1px solid black; padding: 2px;"></td> <td style="border: 1px solid black; padding: 2px;">(1)</td> <td style="border: 1px solid black; padding: 2px;">(2)</td> </tr> </table> | ROHS- | Y | (△) | | (1) | (2) | <p>(1) RoHS regulation conformity (2) Murata classification number</p> |
| ROHS- | Y | (△) | | | | | |
| | (1) | (2) | | | | | |

10.7 Marking on outer box (corrugated box)

Customer name, purchasing order number, customer part number, Murata part number, RoHS marking (*2), quantity, etc.

10.8 Specification of outer box

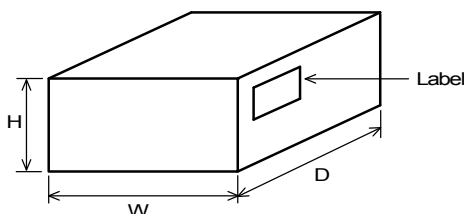

| Dimensions of outer box (mm) | | | Standard reel quantity in outer box (reel) |
|--|-----|----|--|
| W | D | H | |
| 186 | 186 | 93 | 5 |
| * Above outer box size is typical. It depends on a quantity of an order. | | | |

11. ⚠Caution

| | | | | | | | | | | | |
|-----------------------------------|---|------------------------|--|-------------------------|------------------------------|------------------------|---|-----------------------------------|-------------------------------|-----------------------|---|
| <p>Restricted applications</p> | <p>Please contact us before using our products for the applications listed below which require especially high reliability for the prevention of defects which might directly cause damage to the third party's life, body or property.</p> <table style="width: 100%; border-collapse: collapse;"> <tr> <td style="width: 50%; padding: 2px;">(1) Aircraft equipment</td> <td style="width: 50%; padding: 2px;">(6) Transportation equipment (vehicles, trains, ships, etc.)</td> </tr> <tr> <td style="padding: 2px;">(2) Aerospace equipment</td> <td style="padding: 2px;">(7) Traffic signal equipment</td> </tr> <tr> <td style="padding: 2px;">(3) Undersea equipment</td> <td style="padding: 2px;">(8) Disaster/crime prevention equipment</td> </tr> <tr> <td style="padding: 2px;">(4) Power plant control equipment</td> <td style="padding: 2px;">(9) Data-processing equipment</td> </tr> <tr> <td style="padding: 2px;">(5) Medical equipment</td> <td style="padding: 2px;">(10) Applications of similar complexity and/or reliability requirements to the applications listed in the above</td> </tr> </table> | (1) Aircraft equipment | (6) Transportation equipment (vehicles, trains, ships, etc.) | (2) Aerospace equipment | (7) Traffic signal equipment | (3) Undersea equipment | (8) Disaster/crime prevention equipment | (4) Power plant control equipment | (9) Data-processing equipment | (5) Medical equipment | (10) Applications of similar complexity and/or reliability requirements to the applications listed in the above |
| (1) Aircraft equipment | (6) Transportation equipment (vehicles, trains, ships, etc.) | | | | | | | | | | |
| (2) Aerospace equipment | (7) Traffic signal equipment | | | | | | | | | | |
| (3) Undersea equipment | (8) Disaster/crime prevention equipment | | | | | | | | | | |
| (4) Power plant control equipment | (9) Data-processing equipment | | | | | | | | | | |
| (5) Medical equipment | (10) Applications of similar complexity and/or reliability requirements to the applications listed in the above | | | | | | | | | | |

12. Precautions for Use

This product is for use only with reflow soldering. It is designed to be mounted by soldering. If you want to use other mounting method, for example, using a conductive adhesive, please consult us beforehand.

12.1 Land dimensions

The following diagram shows the recommended land dimensions for soldering:

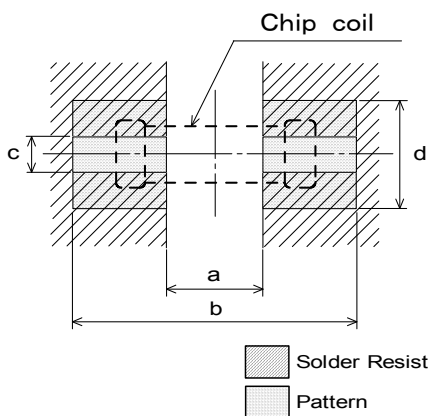

| Applied current (A) | a | b | c | Pattern thickness and dimension d | | |
|---------------------|-----|-----|-----|-----------------------------------|-------|-------|
| | | | | 18 μm | 35 μm | 70 μm |
| 0 to 1.5 | 1.6 | 3.0 | 1.5 | 1.5 | 1.5 | 1.5 |
| 1.5 to 2.6 | 1.6 | 3.0 | 1.5 | 2.4 | 1.5 | 1.5 |
| 2.6 to 3.3 | 1.6 | 3.0 | 1.5 | 3.6 | 2.4 | 1.5 |
| 3.3 to 4.2 | 1.6 | 3.0 | 1.5 | 4.4 | 3.6 | 2.4 |

(in mm)

12.2 Flux and solder used

| | |
|--------|--|
| Flux | <ul style="list-style-type: none"> • Use a rosin-based flux. • Do not use a highly acidic flux with a halide content exceeding 0.2(wt)% (chlorine conversion value). • Do not use a water-soluble flux. |
| Solder | <ul style="list-style-type: none"> • Use Sn-3.0Ag-0.5Cu solder. • Standard thickness of solder paste: 100 μm to 150 μm |

If you want to use a flux other than the above, please consult our technical department.

12.3 Soldering conditions (reflow)

- Pre-heating should be in such a way that the temperature difference between solder and product surface is limited to 150°C max.
Cooling into solvent after soldering also should be in such a way that the temperature difference is limited to 100°C max. Insufficient pre-heating may cause cracks on the product, resulting in the deterioration of product quality.
- Standard soldering profile and the limit soldering profile is as follows.
The excessive limit soldering conditions may cause leaching of the electrode and/or resulting in the deterioration of product quality.



| | Standard profile | Limit profile |
|-------------------------|----------------------------|----------------------------|
| Pre-heating | 150°C to 180°C/90 s ± 30 s | 150°C to 180°C/90 s ± 30 s |
| Heating | Above 220°C/30 s to 60 s | Above 230°C/60 s max. |
| Peak temperature | 245°C ± 3°C | 260°C/10 s |
| Number of reflow cycles | 2 times | 2 times |

12.4 Reworking with soldering iron

The following requirements must be met to rework a soldered product using a soldering iron.

| Item | Requirement |
|-------------------------------------|---------------------|
| Pre-heating | 150°C/approx. 1 min |
| Tip temperature of soldering iron | 350°C max. |
| Power consumption of soldering iron | 80 W max. |
| Tip diameter of soldering iron | ø3 mm max. |
| Soldering time | 3 s (+1 s, -0 s) |
| Number of reworking operations | 2 times max. |

* Avoid a direct contact of the tip of the soldering iron with the product. Such a direction contact may cause cracks in the ceramic body due to thermal shock.

12.5 Solder volume

Solder shall be used not to be exceeded the upper limits as shown below.

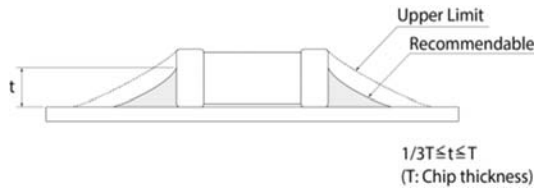

An increased solder volume increases mechanical stress on the product. Exceeding solder volume may cause the failure of mechanical or electrical performance.

12.6 Product's location

The following shall be considered when designing and laying out PCBs.

(1) PCB shall be designed so that products are not subject to mechanical stress due to warping the board.

[Products direction]

Products shall be located in the sideways direction (length: $a < b$) to the mechanical stress.

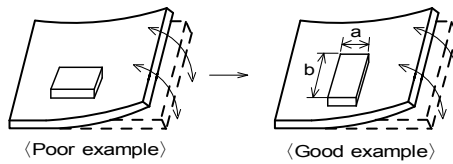

(2) Components location on PCB separation

It is effective to implement the following measures, to reduce stress in separating the board.

It is best to implement all of the following three measures; however, implement as many measures as possible to reduce stress.

| Contents of measures | Stress level |
|---|--------------|
| (1) Turn the mounting direction of the component parallel to the board separation surface. | $A > D^*1$ |
| (2) Add slits in the board separation part. | $A > B$ |
| (3) Keep the mounting position of the component away from the board separation surface. | $A > C$ |
| *1 $A > D$ is valid when stress is added vertically to the perforation as with hand separation. If a cutting disc is used, stress will be diagonal to the PCB, therefore $A > D$ is invalid. | |

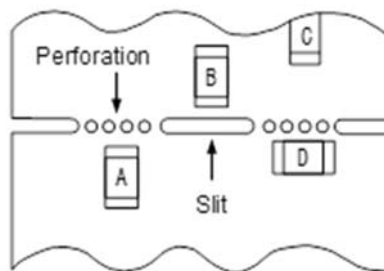

(3) Mounting components near screw holes

When a component is mounted near a screw hole, it may be affected by the board deflection that occurs during the tightening of the screw.

Mount the component in a position as far away from the screw holes as possible.

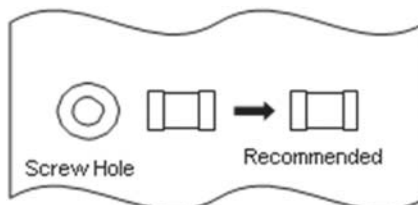

12.7 Handling of substrate

After mounting products on a substrate, do not apply any stress to the product caused by bending or twisting to the substrate when cropping the substrate, inserting and removing a connector from the substrate or tightening screw to the substrate. Excessive mechanical stress may cause cracking in the product.

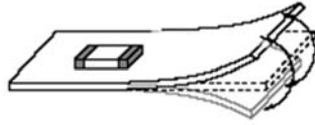

Bending

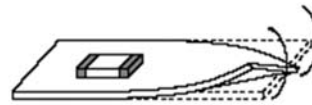

Twisting

12.8 Cleaning

The product shall be cleaned under the following conditions.

- (1) The cleaning temperature shall be 60°C max. If isopropyl alcohol (IPA) is used, the cleaning temperature shall be 40°C max.
- (2) Perform ultrasonic cleaning under the following conditions. Exercise caution to prevent resonance phenomenon in mounted products and the PCB.

| Item | Requirement |
|-----------|------------------|
| Power | 20 W/L max. |
| Time | 5 min max. |
| Frequency | 28 kHz to 40 kHz |

- (3) Cleaner

Alcohol-based cleaner: IPA
Aqueous agent: PINE ALPHA ST-100S

- (4) There shall be no residual flux or residual cleaner. When using aqueous agent, rinse the product with deionized water adequately and completely dry it so that no cleaner is left.

* For other cleaning, consult our technical department.

12.9 Storage and transportation

| | |
|--------------------|--|
| Storage period | Use the product within 6 months after delivery. If you do not use the product for more than 6 months, check solderability before using it. |
| Storage conditions | <ul style="list-style-type: none"> • The products shall be stored in a room not subject to rapid changes in temperature and humidity. The recommended temperature range is -10°C to +40°C. The recommended relative humidity range is 15% to 85%. • Keeping the product in corrosive gases, such as sulfur, chlorine gas or acid may cause the poor solderability. • Do not place the products directly on the floor; they should be placed on a palette so that they are not affected by humidity or dust. • Avoid keeping the products in a place exposed to direct sunlight, heat or vibration. • Avoid storing the product by itself bare (i.e. exposed directly to air). |
| Transportation | Excessive vibration and impact reduces the reliability of the products. Exercise caution when handling the products. |

12.10 Resin coating

The inductance value may change and/or it may affect on the product's performance due to high cure-stress of resin to be used for coating/molding products. So please pay your careful attention when you select resin. In prior to use, please make the reliability evaluation with the product mounted in your application set.

12.11 Handling of product

Inductance could change due to the effect of magnetism. Do not use magnetized tweezers, magnets, or other similar tools when handling the product (instead, use tweezers with resin or ceramic tips).

12.12 Magnetic saturation

A current exceeding the rated current could cause the inductance value to drop due to magnetic saturation.

13. ⚠Note

- (1) Please make sure that your product has been evaluated in view of your specifications with our product being mounted to your product.
- (2) You are requested not to use our product deviating from the reference specifications.
- (3) The contents of this reference specification are subject to change without advance notice. Please approve our product specifications or transact the approval sheet for product specifications before ordering.