





A Product Line of
Diodes Incorporated



SPECIFICATION FOR APPROVAL

CUSTOMER	
NOMINAL FREQUENCY	48.000000 MHz
PRODUCT TYPE	TYPE GB 49S QUARTZ CRYSTAL
PART NUMBER	GB4800024
CUSTOMER P/N	
ISSUE DATE	March 4, 2018
VERSION	B

APPROVED	PREPARED	QA
		

Diodes Incorporated

No.2, Ziqiang 5th Rd., Zhongli Industrial Park,
Zhongli Dist., Taoyuan City 32063, Taiwan (R.O.C.)
TEL:886-3-451-8888
FAX:886-3-461-3865
<https://www.diodes.com>

*RoHS Compliant
*HF-Halogen Free
*REACH Compliant

TYPE GB 49S QUARTZ CRYSTAL

GB4800024

VER.B 04-MAR-18

ELECTRICAL SPECIFICATIONS

Item	Symbol	Specifications	Units	Notes
Nominal Frequency	Fn	48.000000	MHz	
Mode of Oscillation	MO	AT Cut - 3rd OT		
Calibration Load Capacitance	CL	18	pF	
Calibration Tolerance	FL	± 30	ppm	at 25°C $\pm 3^{\circ}\text{C}$
Operating Temperature Range	TR	-40 to +85	°C	
Frequency Stability(Frequency Deviation over the Operating Temperature Range)	F/T	± 30	ppm	Reference to the Frequency at 25°C
Operating Drive Level		100	μW	
Maximum Drive Level		500	μW	
Equivalent Series Resistance	ESR	60	Ω	Max.
Shunt Capacitance	C0	7	pF	Max.
Aging at 25°C		± 5	ppm	Max, 1st year
Storage Temperature		-55 to +125	°C	
Insulation Resistance		500	M Ω	Min

TYPE GB 49S QUARTZ CRYSTAL

GB4800024

VER.B 04-MAR-18

RELIABILITY SPECIFICATIONS

MECHANICAL AND ENVIRONMENTAL RATINGS:

- a) FINE LEAK TEST: JESD22-A109 (Condition 1A)
- b) GROSS LEAK TEST: JESD22-A109 (Condition C)
- c) MOISTURE RESISTANCE: JESD22-A113
- d) SHOCK: JESD22-B104 (Condition B)
- e) SOLDERABILITY : (RoHS version): J-STD-002
- f) VIBRATION: JESD22-B103
- g) SOLVENT RESISTANCE: JESD22-B107
- h) RESISTANCE TO SOLDERING HEAT (RoHS version): J-STD-020D Table 5.2 Pb free devices (3 cycles max)

SUGGESTED IR REFLOW PROFILE

*As per IPC-JEDEC J-STD-020D



Note:

	Stage	Temperature	Time
A	Preheat	150~200°C	60~120 Sec
B	Primary Heat	217°C	60~150 Sec
C	Peak	260°C	10 Sec

TYPE GB 49S QUARTZ CRYSTAL

GB4800024

VER.B 04-MAR-18

MARKING

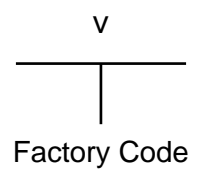
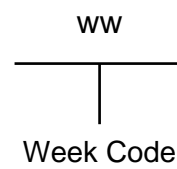
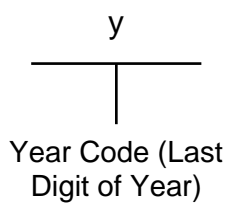
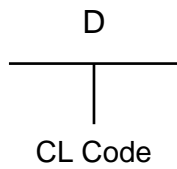
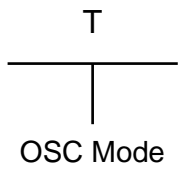
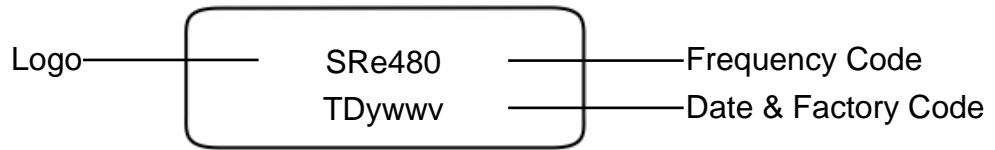

MECHANICAL DRAWINGS (Scale: None. Dimensions are in mm.)

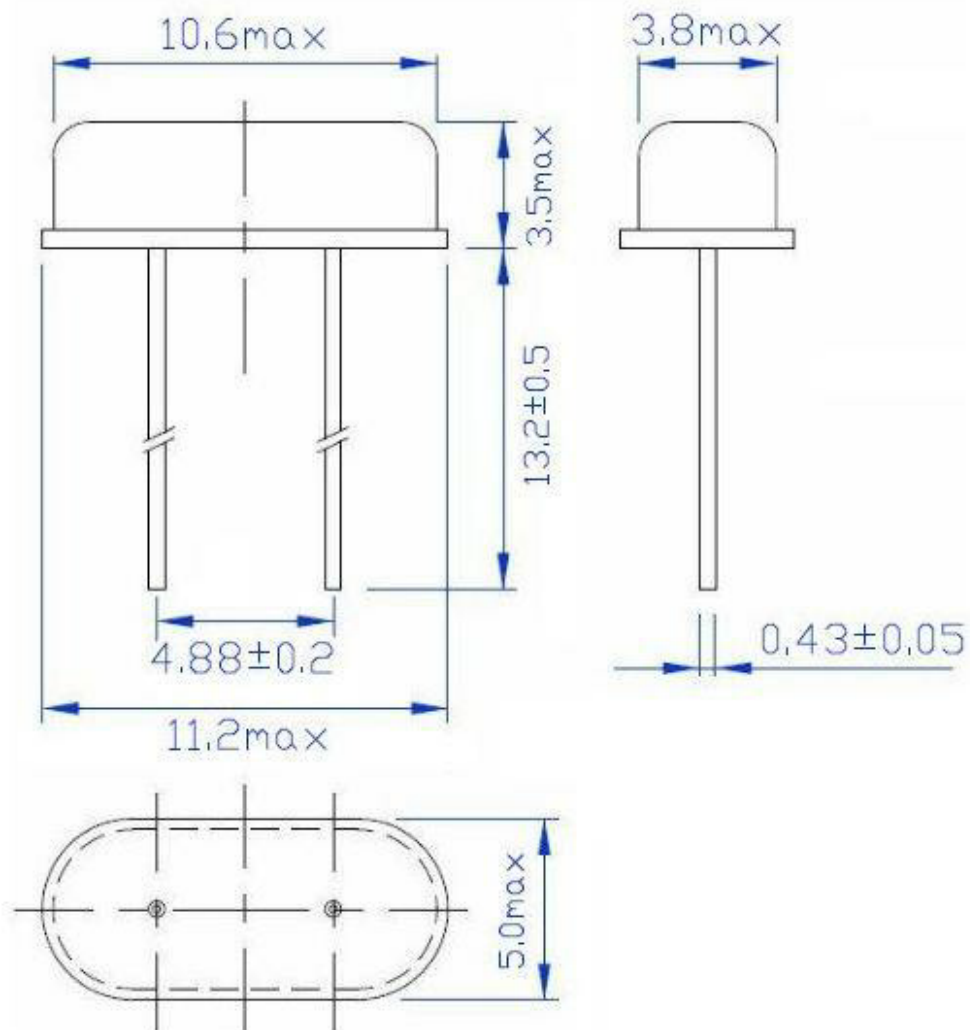

TYPE GB 49S QUARTZ CRYSTAL
GB4800024

VER.B 04-MAR-18

PACKING

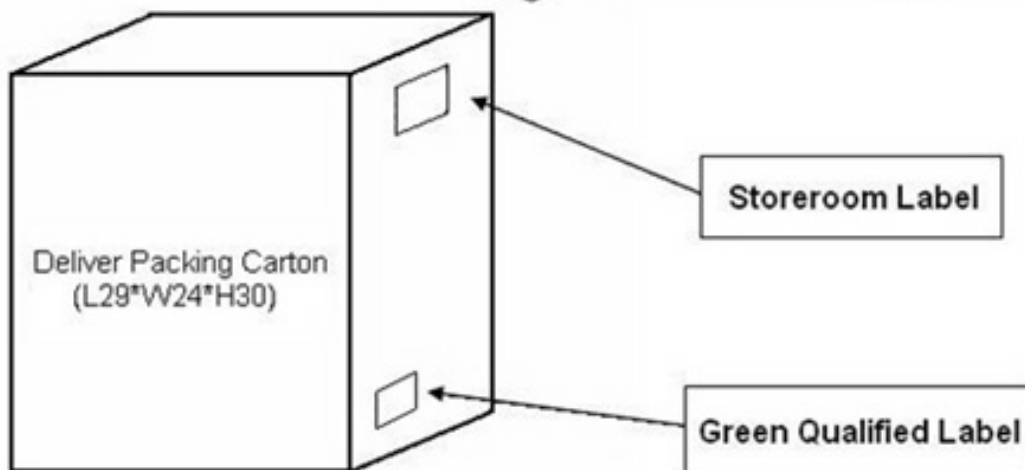
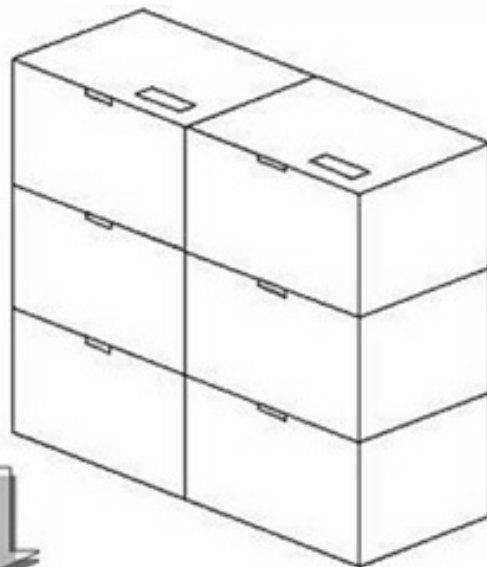
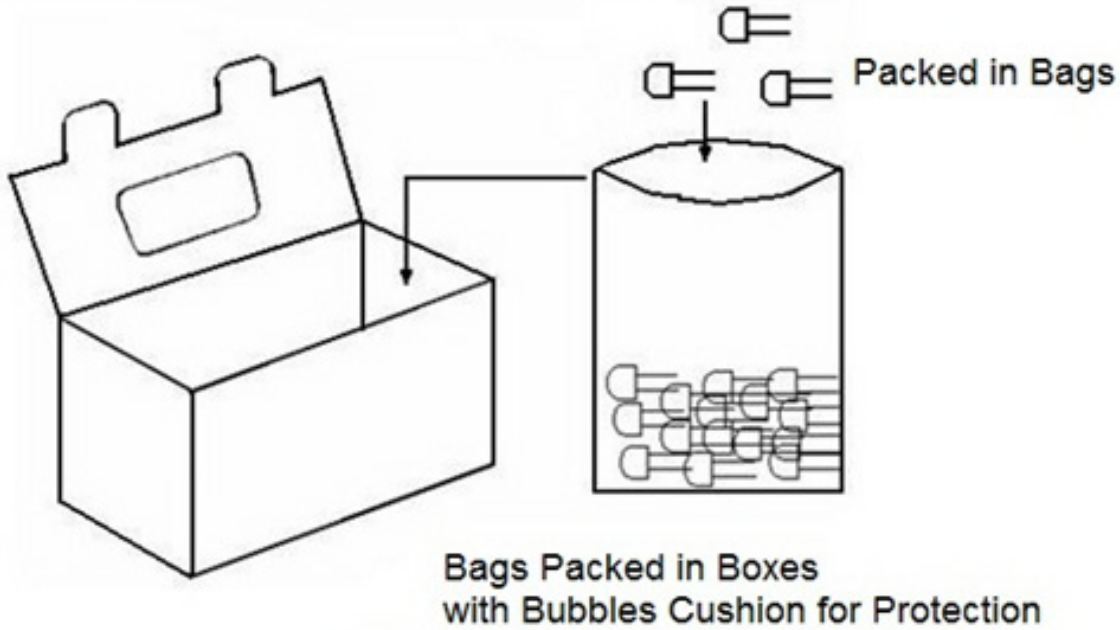

TYPE GB 49S QUARTZ CRYSTAL

GB4800024

VER.B 04-MAR-18

VERSION HISTORY

Version No.	Version Date	Description	Notes
A	Jan. 9, 2012	Initial Release	
B	Mar. 4, 2018	Updated packing & logo	