

Single Channel Silicon ESD Protector Overvoltage Protection Device

Specification Status: Preliminary

BENEFITS

- Industry-leading lowest capacitance; provides lowest insertion loss for high speed data signals
- Small size ESD protection diodes for high speed data signals (0201 size devices)
- Helps protect electronic circuits against damage from Electrostatic Discharge (ESD), surge and cable discharge events
- Assists equipment to pass IEC61000-4-2, level 4 testing

FEATURES

- Low capacitance: 0.10 pF (typ, bi-di)
- Low leakage current: 50nA @ 5V (max)
- Low clamping voltage: $\pm 9.90V$ (typ, bi-di) @ (tp=8x20 μ s, Ipp= 2A)
- ESD maximum rating per IEC61000-4-2 standard:
 - $\pm 20kV$ contact discharge
 - $\pm 20kV$ air discharge
- Surge: 2A (max, bi-di) @ (tp=8x20 μ s) per IEC61000-4-2-5
- Small size and low profile: XDFN packages
- Bi-directional operation



PART NUMBERING

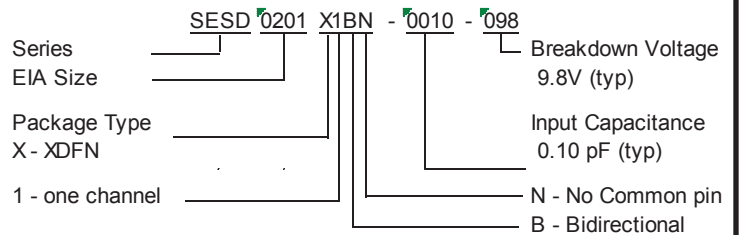

APPLICATIONS

- Consumer, mobile and portable electronics
- Tablet PC and external storage with high speed interfaces
- Ultra-high speed data lines
- USB 3.0/2.0, HDMI 1.3/1.4, DisplayPort, Thunderbolt (Light Peak), V-by-One HS, and LVDS interfaces
- Applications requiring high ESD performance in small packages

MATERIALS INFORMATION

RoHS Compliant ELV Compliant Halogen Free * Lead Free

Directive 2000/53/EC
Compliant

Directive 2002/95/EC
Compliant



* Halogen Free refers to: Br \leq 900ppm, Cl \leq 900ppm, Br+Cl \leq 1500ppm
SESD devices meet MSL-1 Requirements
DFN case epoxy meets UL 94 V-0

SCHEMATIC AND PIN CONFIGURATION

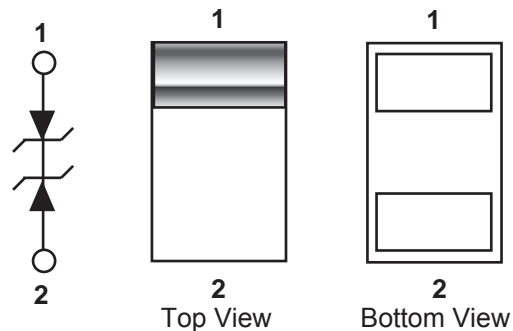

Single Channel Silicon ESD Protector Overvoltage Protection Device

DEVICE MAXIMUM RATING

ESD withstand ⁽¹⁾ (IEC 61000-4-2, level 4)		Temperature		Peak Current (tp=8x20µs)
Contact (kV)	Air (kV)	Operating (°C)	Storage (°C)	Ipp (A)
± 20	± 20	-55 to +125	-55 to +150	2.0

⁽¹⁾ 20kV @ ± 1 pulse; 10kV @ ± 50 pulses; 8kV @ 1,000 pulses (under IEC6100-4-2)

- Device maximum rating @ T = 25°C, unless otherwise specified.
- Caution: Stress exceeding Device Maximum Ratings may damage the device.
Prolonged exposure to stresses above the recommended operating conditions may affect device reliability.

DEVICE ELECTRICAL CHARACTERISTICS

Input Capacitance @ V _R = 0V, f = 3GHz (pF)		Breakdown Voltage V _{BR} @ I _T =1mA (V)	Reverse Working Voltage (V)		Reverse Leakage Current I _L @ V _{WRV} =5.0V (nA)		Clamping Voltage V _{CL} @ I _{pp} =2.0A (V)
Typ	Maximum	Typ	Min	Max	Typ	Max	Max
0.10	0.12	+9.80 / -9.80	-9.00	+9.00	<5.0	50.0	+9.90 / -9.90

- All device electrical characteristics @ T = 25°C, unless otherwise specified.

FIGURE 1. INSERTION LOSS DIAGRAM

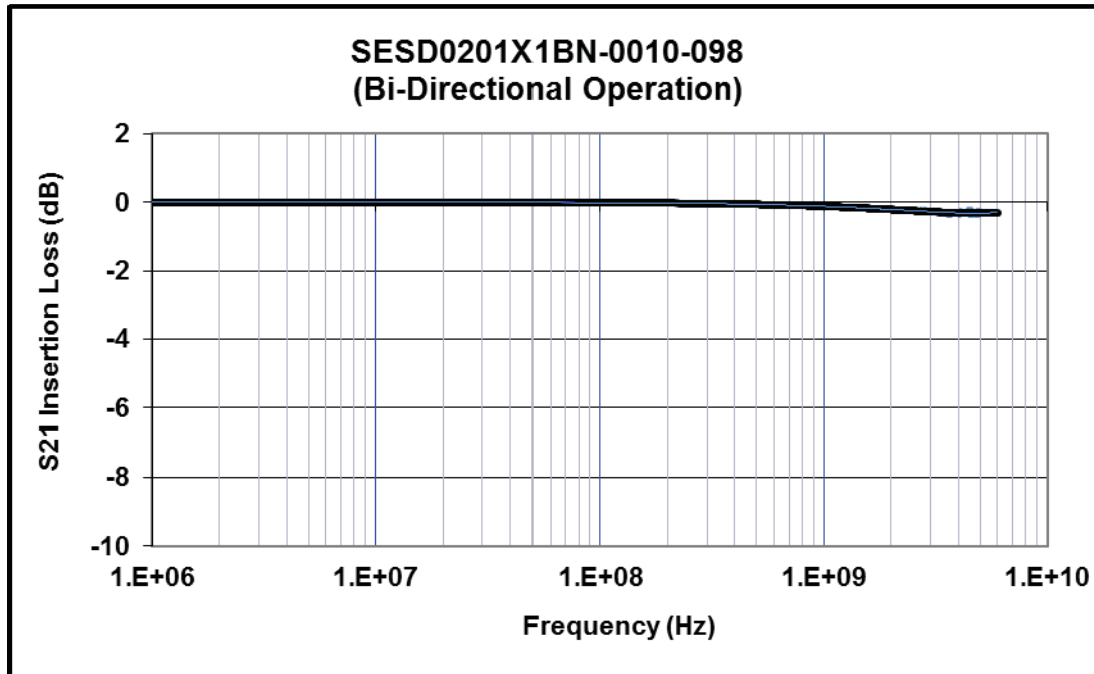

Application	Bit Rate (Gbps)	@Freq (GHz)	Ins. Loss (dB)
HDMI 1.4 (1080P)	2.25	1.13	-0.12
DisplayPort	2.70	1.35	-0.16
HDMI 1.4 (max spec)	3.40	1.70	-0.19
USB3.0	5.00	2.50	-0.23
eSATA	6.00	3.00	-0.27
Thunderbolt	10.0	5.00	-0.30

**Single Channel
Silicon ESD Protector
Overvoltage Protection Device**

FIGURE 2. DEVICE IV CURVE

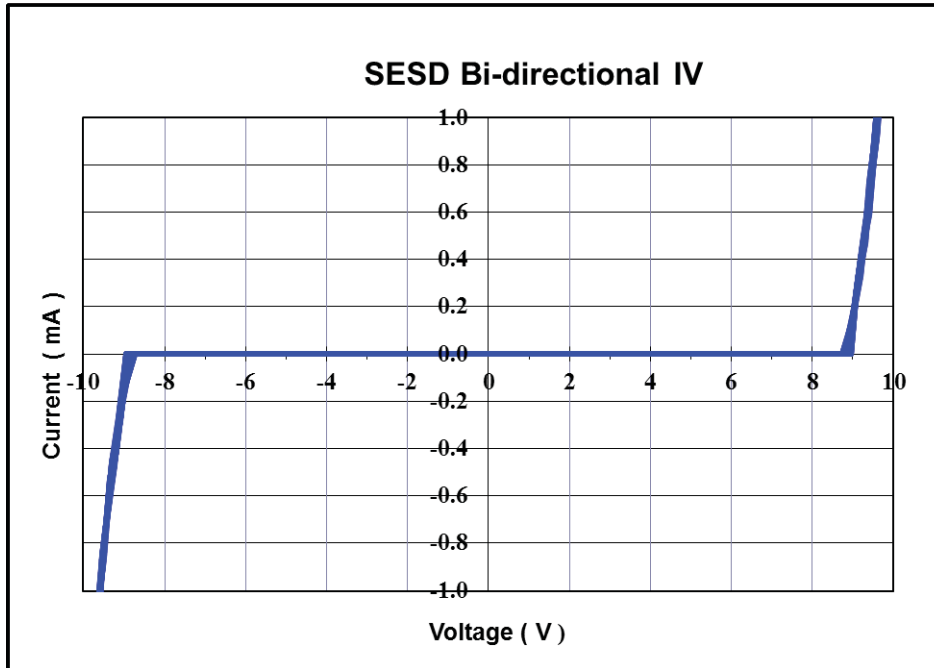
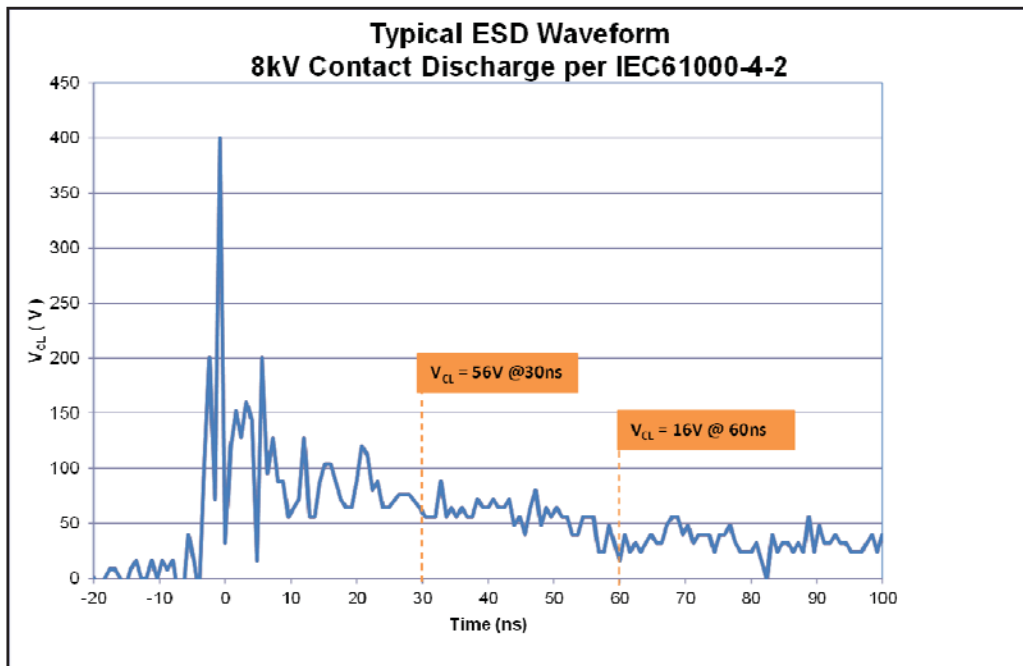

FIGURE 3. ESD WITHSTAND



Single Channel Silicon ESD Protector Overvoltage Protection Device

PRODUCT: SESD0201X1BN-0010-098

DOCUMENT: SCD28185
REV LETTER: A
REV DATE: December 5, 2011
PAGE NO.: Page 4 of 6

DEVICE DIMENSIONS

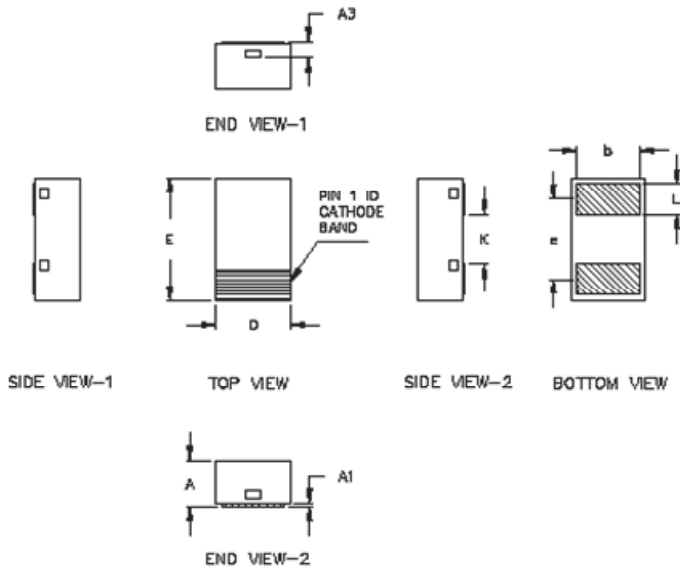

SESD0201X1BN-0010-098						
Dim	Millimeters (mm)			Inches (in)		
	Min	Nom	Max	Min	Nom	Max
A	0.30	0.31	0.32	0.0115	0.0122	0.0125
A1	0	-	0.05	0	-	0.0020
A3	0.102 ref.			0.0040 ref.		
D	0.285	0.320	0.355	0.0112	0.0120	0.0139
E	0.585	0.620	0.655	0.0230	0.0244	0.0237
K	0.130	0.155	0.180	0.0052	0.0061	0.0071
b	0.235	0.260	0.285	0.0083	0.0102	0.0112
L	0.175	0.200	0.225	0.0069	0.0079	0.0088
e	0.355 BSC			0.014 BSC		

BSC – Basic Spacing between Centers

RECOMMENDED LANDING PATTERN:

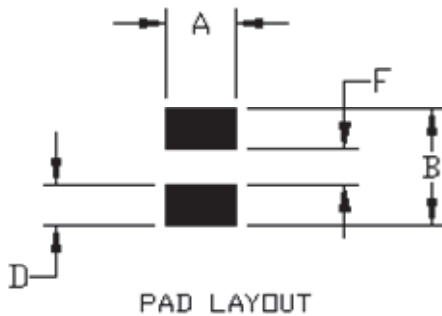

SESD Landing Pad Layout 0201 Package		
Symbol	Millimeters (mm)	Inches (in)
A	0.32	0.013
B	0.62	0.024
D	0.24	0.009
F	0.14	0.006

PACKAGING

Packaging	Tape & Reel	Standard Box
SESD0201X1BN-0010-098	15,000	75,000

Single Channel Silicon ESD Protector Overvoltage Protection Device

DOCUMENT: SCD28185
REV LETTER: A
REV DATE: December 5, 2011
PAGE NO.: Page 5 of 6

REEL DIMENSIONS

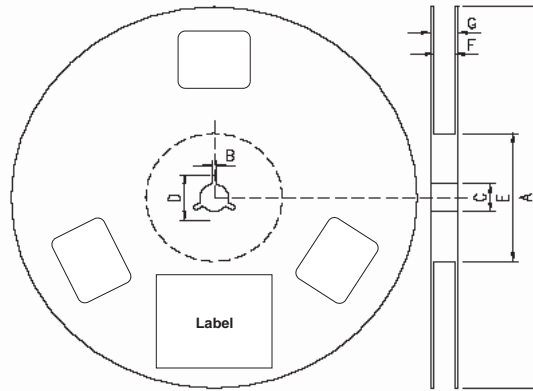

Dimensions	A	B	C	D	E	F	G
(mm)	180.0 ± 1.5	23.0 ± 0.2	13.0 + 0.5 / -0.2	17.3 ± 0.2	60.5 ± 1.5	8.4 + 1.5/-0.0	14.4 (max)

CARRIER TAPE DIMENSIONS

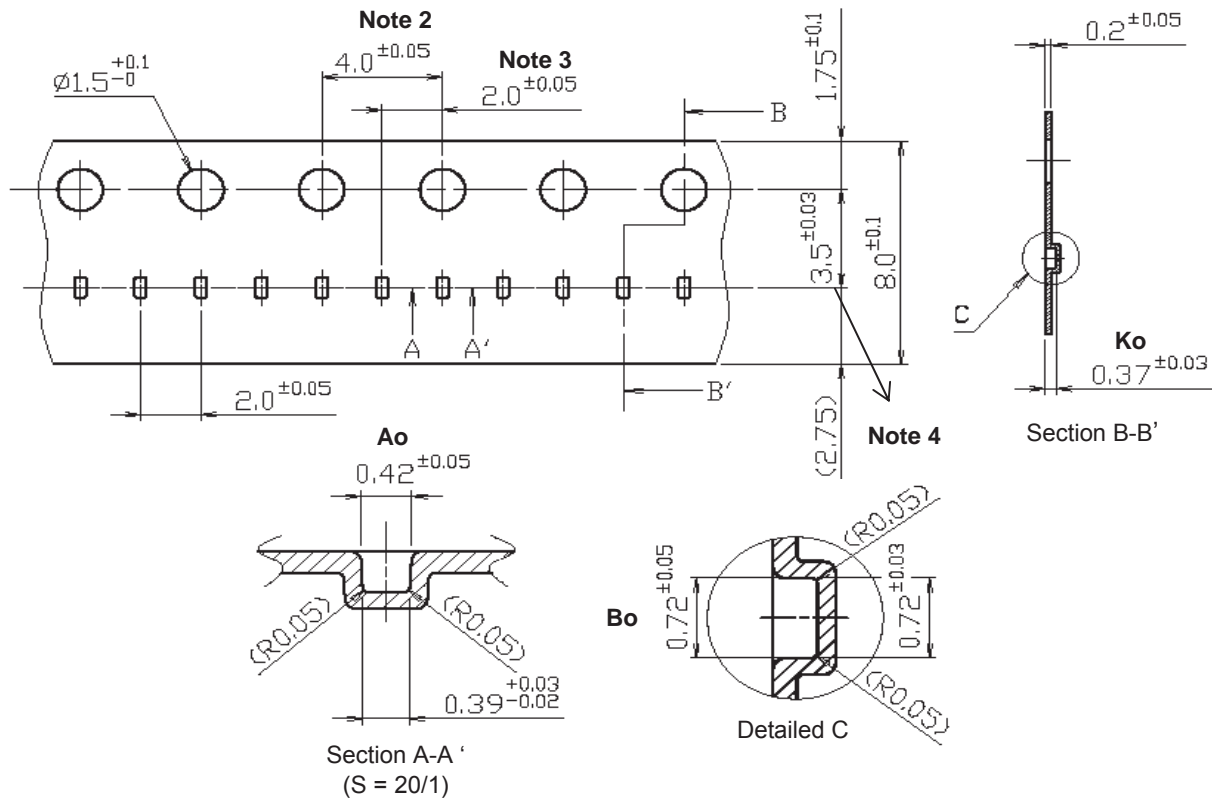

Ao	0.42 ± 0.05
Bo	0.72 ± 0.05
Ko	0.37 ± 0.05

Single Channel Silicon ESD Protector Overvoltage Protection Device

SOLDER REFLOW RECOMMENDATION

A	Temperature ramp up 1	From ambient to Preheating temperature	30s to 60s
B	Preheating	140°C - 160°C	60s to 120s
C	Temperature ramp up 2	From Preheating to Main heating temperature	20s to 40s
D	Main heating	at 200°C at 220°C at 240°C at 260°C	60s ~ 70s 50s ~ 60s 30s ~ 40s 5s ~ 10s
E	Cooling	From main heating temperature to 100°C	4°C/s (max)

FIGURE 4. REFLOW PROFILE

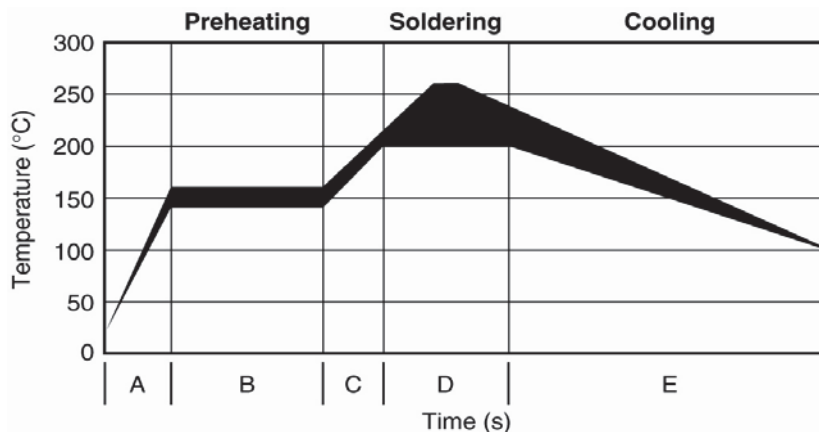

All information, including illustrations, is believed to be accurate and reliable. Users, however, should independently evaluate the suitability of and test each product selected for their application. Tyco Electronics Corporation and/or its Affiliates in the TE Connectivity Ltd. family of companies ("TE") make no warranties as to the accuracy or completeness of the information, and disclaims any liability regarding its use. TE only obligations are those in the TE Standard Terms and Conditions of Sale and in no case will TE be liable for any incidental, indirect, or consequential damages arising from the sale, resale, use, or misuse of its products. Specifications are subject to change without notice. In addition, TE reserves the right to make changes to materials or processing that do not affect compliance with any applicable specification without notification to Buyer. Without expressed or written consent by an officer of TE, TE does not authorize the use of any of its products as components in nuclear facility applications, aerospace, or in critical life support devices or systems.

TE Connectivity, TE Connectivity (logo), and TE (logo) are trademarks.

Other logos, products and /or company names might be trademarks of their respective owners.