

# LMR33630-Q1 3.8-V to 36-V, 3-A Synchronous Step-Down Voltage Converter

## 1 Features

- AEC-Q100 qualified for automotive applications:
  - Temperature grade 1:  $-40^{\circ}\text{C}$  to  $+125^{\circ}\text{C}$ ,  $T_A$
- **Functional Safety-Capable**
  - [Documentation available to aid functional safety system design](#)
- Configured for rugged automotive applications
  - Input voltage range: 3.8 V to 36 V
  - Output voltage range: 1 V to 24 V
  - Output current: 3 A
  - 75-m $\Omega$ /50-m $\Omega$   $R_{DS-ON}$  power MOSFETs
  - Peak-current-mode control
  - Short minimum on-time of 68 ns
  - Frequency: 400 kHz, 1.4 MHz, 2.1 MHz
  - Integrated compensation network
- Low **EMI** and switching noise
  - HotRod™ package
  - Parallel input current paths
- High power conversion at all loads
  - Peak efficiency > 95%
  - Low shutdown quiescent current of 5  $\mu\text{A}$
  - Low operating quiescent current of 25  $\mu\text{A}$
- Create a custom design using the LMR33630-Q1 with the [WEBENCH® Power Designer](#)

## 2 Applications

- **Infotainment and cluster : USB charge**
- **Telematics control unit**

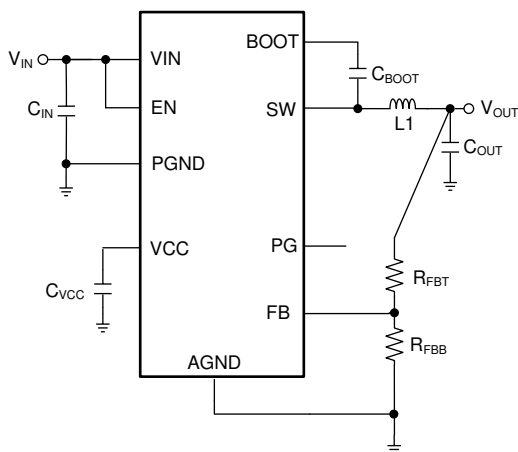

**Simplified Schematic**

## 3 Description

The LMR33630-Q1 automotive-qualified regulator is an easy-to-use, synchronous, step-down DC/DC converter that delivers best-in-class efficiency for rugged applications. The LMR33630-Q1 drives up to 3 A of load current from an input of up to 36 V. The LMR33630-Q1 provides high light load efficiency and output accuracy in a very small solution size. Features such as a power-good flag and precision enable provide both flexible and easy-to-use solutions for a wide range of applications. The LMR33630-Q1 automatically folds back frequency at light load to improve efficiency. Integration eliminates most external components and provides a pinout designed for simple PCB layout. Protection features include thermal shutdown, input undervoltage lockout, cycle-by-cycle current limit, and hiccup short-circuit protection. The LMR33630-Q1 is available in a 12-pin 3 mm × 2 mm next generation VQFN package with wettable flanks.

### Device Information

PART NUMBER	PACKAGE <sup>(1)</sup>	BODY SIZE (NOM)
LMR33630-Q1	VQFN (12)	3.00 mm × 2.00 mm

- (1) For all available packages, see the orderable addendum at the end of the data sheet.

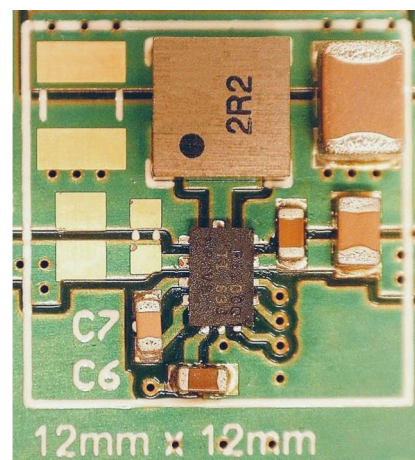

**Minimum Component Example**



## Table of Contents

<b>1 Features</b> .....	1	7.4 Device Functional Modes.....	15
<b>2 Applications</b> .....	1	<b>8 Application and Implementation</b> .....	19
<b>3 Description</b> .....	1	8.1 Application Information.....	19
<b>4 Revision History</b> .....	2	8.2 Typical Application.....	19
<b>5 Pin Configuration and Functions</b> .....	4	8.3 What to Do and What Not to Do.....	30
<b>6 Specifications</b> .....	5	<b>9 Power Supply Recommendations</b> .....	31
6.1 Absolute Maximum Ratings.....	5	<b>10 Layout</b> .....	32
6.2 ESD Ratings.....	5	10.1 Layout Guidelines.....	32
6.3 Recommended Operating Conditions.....	5	10.2 Layout Example.....	34
6.4 Thermal Information.....	6	<b>11 Device and Documentation Support</b> .....	35
6.5 Electrical Characteristics.....	6	11.1 Device Support.....	35
6.6 Timing Characteristics.....	8	11.2 Documentation Support.....	35
6.7 System Characteristics.....	9	11.3 Support Resources.....	35
6.8 Typical Characteristics.....	10	11.4 Receiving Notification of Documentation Updates..	35
<b>7 Detailed Description</b> .....	11	11.5 Trademarks.....	35
7.1 Overview.....	11	11.6 Electrostatic Discharge Caution.....	36
7.2 Functional Block Diagram.....	11	11.7 Glossary.....	36
7.3 Feature Description.....	12		

## 4 Revision History

NOTE: Page numbers for previous revisions may differ from page numbers in the current version.

<b>Changes from Revision B (March 2019) to Revision C (October 2020)</b>	<b>Page</b>
• Added functional safety bullet in the <i>Features</i> .....	1
• Added low EMI and switching noise bullet to the <i>Features</i> .....	1
• Updated the numbering format for tables, figures and cross-references throughout the document. ....	1
<b>Changes from Revision A (November 2018) to Revision B (March 2019)</b>	<b>Page</b>
• Changed block diagram to fix drawing error.....	11
<b>Changes from Revision * (June 2018) to Revision A (November 2018)</b>	<b>Page</b>
• First release of production-data data sheet .....	1

## Device Comparison Table

DEVICE OPTION	PACKAGE	FREQUENCY	RATED CURRENT	OUTPUT VOLTAGE
LMR33630AQRNX	RNX (12-pin VQFN) 3 × 2 × 0.85 mm	400 kHz	3 A	Adjustable
LMR33630BQRNX		1400 kHz	3 A	
LMR33630CQRNX		2100 kHz	3 A	

## 5 Pin Configuration and Functions

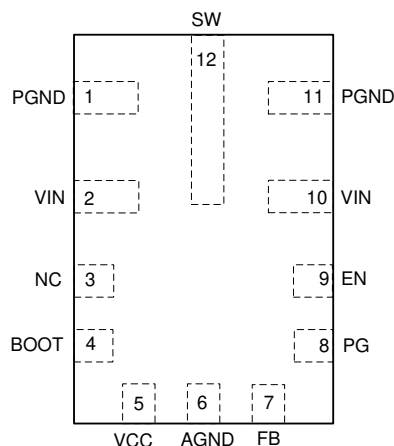

**Figure 5-1. 12-Pin VQFN RNX Package (Top View)**

**Table 5-1. Pin Functions**

PIN		TYPE	DESCRIPTION
NO.	NAME		
1, 11	PGND	G	Power ground terminal. Connect to system ground and AGND. Connect to a bypass capacitor with short wide traces.
2, 10	VIN	P	Input supply to regulator. Connect a high-quality bypass capacitor(s) directly to this pin and PGND.
3	NC	—	On the VQFN package, connect the SW pin to NC on the PCB. This simplifies the connection from the C <sub>BOOT</sub> capacitor to the SW pin. This pin has no internal connection to the regulator.
4	BOOT	P	Boot-strap supply voltage for internal high-side driver. Connect a high-quality 100-nF capacitor from this pin to the SW pin. On the VQFN package connect the SW pin to NC on the PCB. This simplifies the connection from the C <sub>BOOT</sub> capacitor to the SW pin.
5	VCC	P	Internal 5-V LDO output. Used as supply to internal control circuits. Do not connect to external loads. Can be used as logic supply for power-good flag. Connect a high quality 1-μF capacitor from this pin to GND.
6	AGND	G	Analog ground for regulator and system. Ground reference for internal references and logic. All electrical parameters are measured with respect to this pin. Connect to system ground on PCB.
7	FB	A	Feedback input to regulator. Connect to tap point of feedback voltage divider. DO NOT FLOAT. DO NOT GROUND.
8	PG	A	Open drain power-good flag output. Connect to suitable voltage supply through a current limiting resistor. High = power OK, low = power bad. Flag pulls low when EN = Low. Can be left open when not used.
9	EN	A	Enable input to regulator. High = ON, low = OFF. Can be connected directly to VIN; DO NOT FLOAT.
12	SW	P	Regulator switch node. Connect to power inductor. On the VQFN package the SW pin must be connected to NC on the PCB. This simplifies the connection from the C <sub>BOOT</sub> capacitor to the SW pin.

A = Analog, P = Power, G = Ground

## 6 Specifications

### 6.1 Absolute Maximum Ratings

Over the recommended operating junction temperature range<sup>(1)</sup>

PARAMETER		MIN	MAX	UNIT
Voltages	VIN to PGND	-0.3	38	V
	EN to AGND <sup>(2)</sup>	-0.3	V <sub>IN</sub> + 0.3	
	FB to AGND	-0.3	5.5	
	PG to AGND <sup>(2)</sup>	0	22	
	AGND to PGND	-0.3	0.3	V
	SW to PGND	-0.3	V <sub>IN</sub> + 0.3	
	SW to PGND less than 100-ns transients	-3.5	38	
	BOOT to SW	-0.3	5.5	
	VCC to AGND <sup>(4)</sup>	-0.3	5.5	
T <sub>J</sub>	Junction temperature <sup>(3)</sup>	-40	150	°C
T <sub>stg</sub>	Storage temperature	-55	150	°C

- (1) Stresses beyond those listed under *Absolute Maximum Ratings* may cause permanent damage to the device. These are stress ratings only, which do not imply functional operation of the device at these or any other conditions beyond those indicated under *Recommended Operating Conditions*. Exposure to absolute-maximum-rated conditions for extended periods may affect device reliability.
- (2) The voltage on this pin must not exceed the voltage on the VIN pin by more than 0.3 V.
- (3) Operating at junction temperatures greater than 125°C, although possible, degrades the lifetime of the device.
- (4) Under some operating conditions the VCC LDO voltage may increase beyond 5.5V.

### 6.2 ESD Ratings

			VALUE	UNIT
V <sub>(ESD)</sub>	Electrostatic discharge	Human-body model (HBM), per AEC Q100-002 <sup>(1)</sup> HBM ESD Classification Level 2	±2500	V
		Charged-device model (CDM), per AEC Q100-011 CDM ESD Classification Level C5	±750	

- (1) AEC Q100-002 indicates that HBM stressing shall be in accordance with ANSI/ESDA/JEDEC JS-001 specification.

### 6.3 Recommended Operating Conditions

Over the recommended operating temperature range of -40 °C to 125 °C (unless otherwise noted) <sup>(1)</sup>

		MIN	MAX	UNIT
Input voltage	VIN to PGND	3.8	36	V
	EN <sup>(2)</sup>	0	V <sub>IN</sub>	
	PG <sup>(2)</sup>	0	18	
Adjustable output voltage	V <sub>OUT</sub> <sup>(3)</sup>	1	24	V
Output current	I <sub>OUT</sub>	0	3	A

- (1) Recommended operating conditions indicate conditions for which the device is intended to be functional, but do not ensure specific performance limits. For ensured specifications, see [Section 6.5](#).
- (2) The voltage on this pin must not exceed the voltage on the VIN pin by more than 0.3 V.
- (3) The maximum output voltage can be extended to 95% of V<sub>IN</sub>; contact TI for details. Under no conditions should the output voltage be allowed to fall below zero volts.

## 6.4 Thermal Information

The value of  $R_{\theta JA}$  given in this table is only valid for comparison with other packages and can not be used for design purposes. These values were calculated in accordance with JESD 51-7, and simulated on a 4-layer JEDEC board. They do not represent the performance obtained in an actual application. For design information see *Maximum Ambient Temperature* section.

THERMAL METRIC <sup>(1) (2)</sup>		LMR336x0	UNIT
		RNX (VQFN)	
		12 PINS	
$R_{\theta JA}$	Junction-to-ambient thermal resistance	72.5 <sup>(2)</sup>	°C/W
$R_{\theta JC(top)}$	Junction-to-case (top) thermal resistance	35.9	°C/W
$R_{\theta JB}$	Junction-to-board thermal resistance	23.3	°C/W
$\Psi_{JT}$	Junction-to-top characterization parameter	0.8	°C/W
$\Psi_{JB}$	Junction-to-board characterization parameter	23.5	°C/W
$R_{\theta JC(bot)}$	Junction-to-case (bottom) thermal resistance	N/A	°C/W

- (1) For more information about traditional and new thermal metrics, see the [Semiconductor and IC Package Thermal Metrics](#) application report.
- (2) The value of  $R_{\theta JA}$  given in this table is only valid for comparison with other packages and can not be used for design purposes. These values were calculated in accordance with JESD 51-7, and simulated on a 4-layer JEDEC board. They do not represent the performance obtained in an actual application. For design information see *Maximum Ambient Temperature* section.

## 6.5 Electrical Characteristics

Limits apply over the operating junction temperature ( $T_J$ ) range of  $-40^{\circ}\text{C}$  to  $+125^{\circ}\text{C}$ , unless otherwise stated. Minimum and maximum limits are specified through test, design or statistical correlation. Typical values represent the most likely parametric norm at  $T_J = 25^{\circ}\text{C}$ , and are provided for reference purposes only. Unless otherwise stated, the following conditions apply:  $V_{IN} = 12\text{ V}$ ,  $V_{EN} = 4\text{ V}$ .

PARAMETER		TEST CONDITIONS	MIN	TYP	MAX	UNIT
<b>SUPPLY VOLTAGE</b>						
$V_{IN}$	Minimum operating input voltage				3.8	V
$I_Q$	Non-switching input current; measured at VIN pin <sup>(2)</sup>	$V_{FB} = 1.2\text{ V}$		24	34	$\mu\text{A}$
$I_{SD}$	Shutdown quiescent current; measured at VIN pin	$EN = 0$		5	10	$\mu\text{A}$
<b>ENABLE</b>						
$V_{EN-VCC-H}$	EN input level required to turn on internal LDO	Rising threshold			1	V
$V_{EN-VCC-L}$	EN input level required to turn off internal LDO	Falling threshold	0.3			V
$V_{EN-H}$	EN input level required to start switching	Rising threshold	1.2	1.231	1.26	V
$V_{EN-HYS}$	Hysteresis below $V_{EN-H}$	Hysteresis below $V_{EN-H}$ ; falling		100		mV
$I_{LKG-EN}$	Enable input leakage current	$V_{EN} = 3.3\text{ V}$		0.2		nA
<b>INTERNAL SUPPLIES</b>						
VCC	Internal LDO output voltage appearing at the VCC pin	$6\text{ V} \leq V_{IN} \leq 36\text{ V}$	4.75	5	5.25	V
$V_{BOOT-UVLO}$	Bootstrap voltage undervoltage lock-out threshold <sup>(3)</sup>			2.2		V
<b>VOLTAGE REFERENCE (FB PIN)</b>						
$V_{FB}$	Feedback voltage; ADJ option		0.985	1	1.015	V
$I_{FB}$	Current into FB pin; ADJ option	$FB = 1\text{ V}$		0.2	50	nA
<b>CURRENT LIMITS<sup>(4)</sup></b>						
$I_{SC}$	High-side current limit	LMR33630	3.85	4.5	5.05	A
$I_{LIMIT}$	Low-side current limit	LMR33630	2.9	3.5	4.1	A

Limits apply over the operating junction temperature ( $T_J$ ) range of  $-40^{\circ}\text{C}$  to  $+125^{\circ}\text{C}$ , unless otherwise stated. Minimum and maximum limits are specified through test, design or statistical correlation. Typical values represent the most likely parametric norm at  $T_J = 25^{\circ}\text{C}$ , and are provided for reference purposes only. Unless otherwise stated, the following conditions apply:  $V_{IN} = 12\text{ V}$ ,  $V_{EN} = 4\text{ V}$ .

PARAMETER		TEST CONDITIONS	MIN	TYP	MAX	UNIT
$I_{PEAK-MIN}$	Minimum peak inductor current	LMR33630		0.69		A
$I_{ZC}$	Zero current detector threshold			-0.106		A
<b>SOFT START</b>						
$t_{SS}$	Internal soft-start time		2.9	4	6	ms
<b>POWER GOOD (PG PIN)</b>						
$V_{PG-HIGH-UP}$	Power-good upper threshold - rising	% of FB voltage	105%	107%	110%	
$V_{PG-HIGH-DN}$	Power-good upper threshold - falling	% of FB voltage	103%	105%	108%	
$V_{PG-LOW-UP}$	Power-good lower threshold - rising	% of FB voltage	92%	94%	97%	
$V_{PG-LOW-DN}$	Power-good lower threshold - falling	% of FB voltage	90%	92%	95%	
$t_{PG}$	Power-good glitch filter delay <sup>(1)</sup>		60		170	$\mu\text{s}$
$R_{PG}$	Power-good flag $R_{DSON}$	$V_{IN} = 12\text{ V}$ , $V_{EN} = 4\text{ V}$		76	150	$\Omega$
		$V_{EN} = 0\text{ V}$		35	60	
$V_{IN-PG}$	Minimum input voltage for proper PG function	50- $\mu\text{A}$ , $EN = 0\text{ V}$			2	V
$V_{PG}$	PG logic low output	50- $\mu\text{A}$ , $EN = 0\text{ V}$ , $V_{IN} = 2\text{ V}$			0.2	V
<b>OSCILLATOR</b>						
$f_{SW}$	Switching frequency	"A" Version	340	400	460	kHz
$f_{SW}$	Switching frequency	"B" Version	1.2	1.4	1.6	MHz
$f_{SW}$	Switching frequency	"C" Version, RNX package	1.8	2.1	2.3	MHz

Limits apply over the operating junction temperature ( $T_J$ ) range of  $-40^{\circ}\text{C}$  to  $+125^{\circ}\text{C}$ , unless otherwise stated. Minimum and maximum limits are specified through test, design or statistical correlation. Typical values represent the most likely parametric norm at  $T_J = 25^{\circ}\text{C}$ , and are provided for reference purposes only. Unless otherwise stated, the following conditions apply:  $V_{IN} = 12\text{ V}$ ,  $V_{EN} = 4\text{ V}$ .

PARAMETER		TEST CONDITIONS	MIN	TYP	MAX	UNIT
<b>MOSFETS</b>						
$R_{DS-ON-HS}$	High-side MOSFET ON-resistance	RNX package		75	145	m $\Omega$
$R_{DS-ON-LS}$	Low-side MOSFET ON-resistance	RNX package		50	95	m $\Omega$

- (1) See *Power-Good Flag Output* for details.
- (2) This is the current used by the device open loop. It does not represent the total input current of the system when in regulation.
- (3) When the voltage across the  $C_{BOOT}$  capacitor falls below this voltage, the low side MOSFET is turned on to recharge  $C_{BOOT}$ .
- (4) The current limit values in this table are tested, open loop, in production. They may differ from those found in a closed loop application.

## 6.6 Timing Characteristics

Limits apply over the operating junction temperature ( $T_J$ ) range of  $-40^{\circ}\text{C}$  to  $+125^{\circ}\text{C}$ , unless otherwise stated. Minimum and maximum limits are specified through test, design or statistical correlation. Typical values represent the most likely parametric norm at  $T_J = 25^{\circ}\text{C}$ , and are provided for reference purposes only. Unless otherwise stated, the following conditions apply:  $V_{IN} = 12\text{ V}$ ,  $V_{EN} = 4\text{ V}$ .

			MIN	NOM	MAX	UNIT
$t_{ON-MIN}$	Minimum switch on-time	RNX package		68	80	ns
$t_{OFF-MIN}$	Minimum switch off-time	RNX package		52	70	ns
$t_{ON-MAX}$	Maximum switch on-time			7	9	$\mu\text{s}$



## 6.7 System Characteristics

The following specifications apply to a typical applications circuit, with nominal component values. Specifications in the typical (TYP) column apply to  $T_J = 25^\circ\text{C}$  only. Specifications in the minimum (MIN) and maximum (MAX) columns apply to the case of typical components over the temperature range of  $T_J = -40^\circ\text{C}$  to  $125^\circ\text{C}$ . *These specifications are not ensured by production testing.*

PARAMETER		TEST CONDITIONS	MIN	TYP	MAX	UNIT
$V_{IN}$	Operating input voltage range	$V_{OUT} = 3.3\text{ V}$ , $I_{OUT} = 0\text{ A}$	3.8		36	V
$V_{OUT}$	Output voltage regulation for $V_{OUT} = 5\text{ V}^{(1)}$	$V_{OUT} = 5\text{ V}$ , $V_{IN} = 7\text{ V to } 36\text{ V}$ , $I_{OUT} = 0\text{ A to max. load}$	-1.5%		2.5%	
		$V_{OUT} = 5\text{ V}$ , $V_{IN} = 7\text{ V to } 36\text{ V}$ , $I_{OUT} = 1\text{ A to max. load}$	-1.5%		1.5%	
	Output voltage regulation for $V_{OUT} = 3.3\text{ V}^{(1)}$	$V_{OUT} = 3.3\text{ V}$ , $V_{IN} = 3.8\text{ V to } 36\text{ V}$ , $I_{OUT} = 0\text{ A to max. load}$	-1.5%		2.5%	
		$V_{OUT} = 3.3\text{ V}$ , $V_{IN} = 3.8\text{ V to } 36\text{ V}$ , $I_{OUT} = 1\text{ A to max. load}$	-1.5%		1.5%	
$I_{SUPPLY}$	Input supply current when in regulation	$V_{IN} = 12\text{ V}$ , $V_{OUT} = 3.3\text{ V}$ , $I_{OUT} = 0\text{ A}$ , $R_{FBT} = 1\text{ M}\Omega$		25		$\mu\text{A}$
$V_{DROP}$	Dropout voltage; $(V_{IN} - V_{OUT})$	$V_{OUT} = 5\text{ V}$ , $I_{OUT} = 1\text{ A}$ Dropout at -1% of regulation, $f_{SW} = 140\text{ kHz}$		150		mV
$D_{MAX}$	Maximum switch duty cycle <sup>(2)</sup>	$V_{IN} = V_{OUT} = 12\text{ V}$ , $I_{OUT} = 1\text{ A}$		98%		
$V_{HC}$	FB pin voltage required to trip short-circuit hiccup mode			0.4		V
$t_{HC}$	Time between current-limit hiccup burst			94		ms
$t_D$	Switch voltage dead time			2		ns
$T_{SD}$	Thermal shutdown temperature	Shutdown temperature		165		$^\circ\text{C}$
		Recovery temperature		148		$^\circ\text{C}$

(1) Deviation is with respect to  $V_{IN} = 12\text{ V}$ ,  $I_{OUT} = 1\text{ A}$ .

(2) In dropout the switching frequency drops to increase the effective duty cycle. The lowest frequency is clamped at approximately:  $f_{MIN} = 1 / (t_{ON-MAX} + t_{OFF-MIN})$ .  $D_{MAX} = t_{ON-MAX} / (t_{ON-MAX} + t_{OFF-MIN})$ .

## 6.8 Typical Characteristics

Unless otherwise specified the following conditions apply:  $T_A = 25^\circ\text{C}$  and  $V_{IN} = 12\text{ V}$

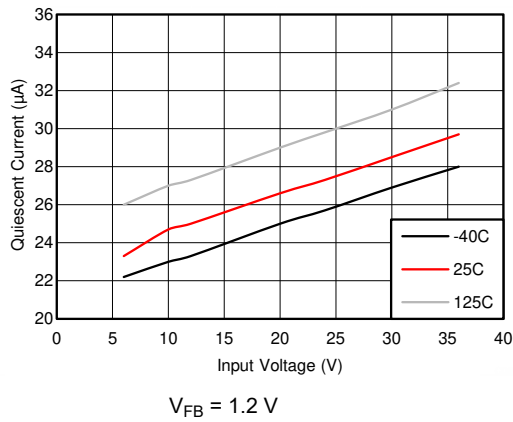

**Figure 6-1. Non-Switching Input Supply Current**

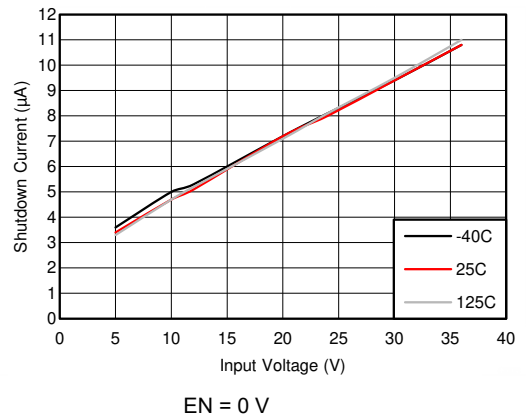

**Figure 6-2. Shutdown Supply Current**

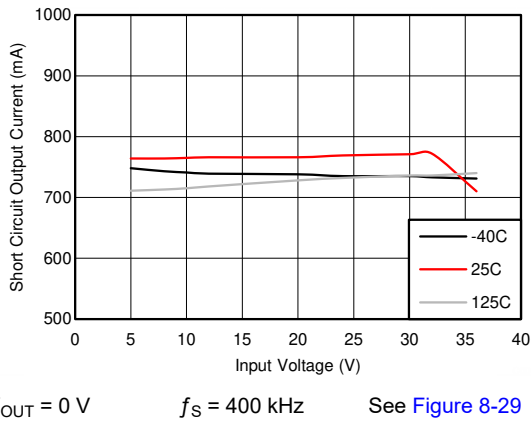

**Figure 6-3. Short-Circuit Output Current**

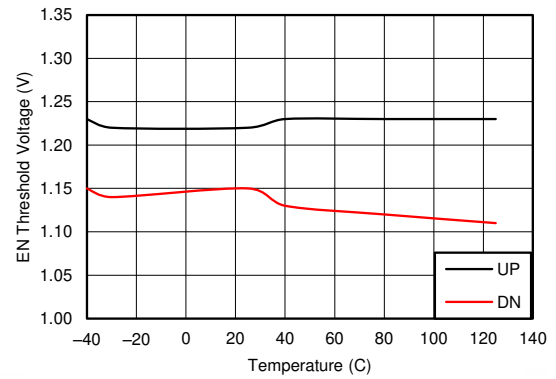

**Figure 6-4. Precision Enable Thresholds**

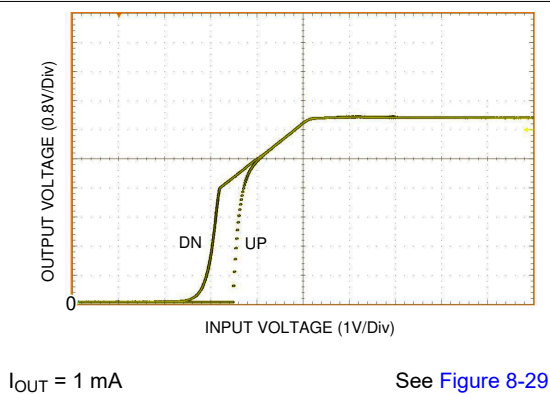

**Figure 6-5. UVLO Thresholds**

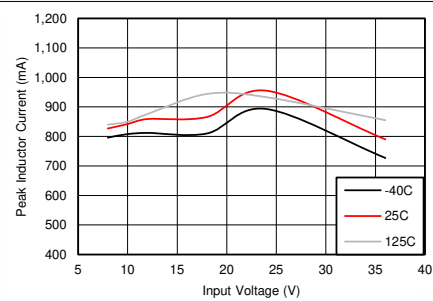

**Figure 6-6.  $I_{PEAK-MIN}$**

## 7 Detailed Description

### 7.1 Overview

The LMR33630-Q1 is a synchronous peak-current-mode buck regulator designed for a wide variety of applications. Advanced high speed circuitry allows the device to regulate from an input voltage of 20 V, while providing an output voltage of 3.3 V at a switching frequency of 2.1 MHz. The innovative architecture allows the device to regulate a 3.3-V output from an input of only 3.8 V. The regulator automatically switches modes between PFM and PWM depending on load. At heavy loads, the device operates in PWM at a constant switching frequency. At light loads, the mode changes to PFM with diode emulation allowing DCM. This reduces the input supply current and keeps efficiency high. The device features internal loop compensation which reduces design time and requires fewer external components than externally compensated regulators.

The LMR33630-Q1 is available in an ultra-miniature VQFN package with wettable flanks. This package features extremely small parasitic inductance and resistance, enabling very high efficiency while minimizing switch node ringing and dramatically reducing EMI. The VIN/PGND pin layout is symmetrical on either side of the VQFN package. This allows the input current magnetic fields to partially cancel, resulting in reduce EMI generation.

### 7.2 Functional Block Diagram

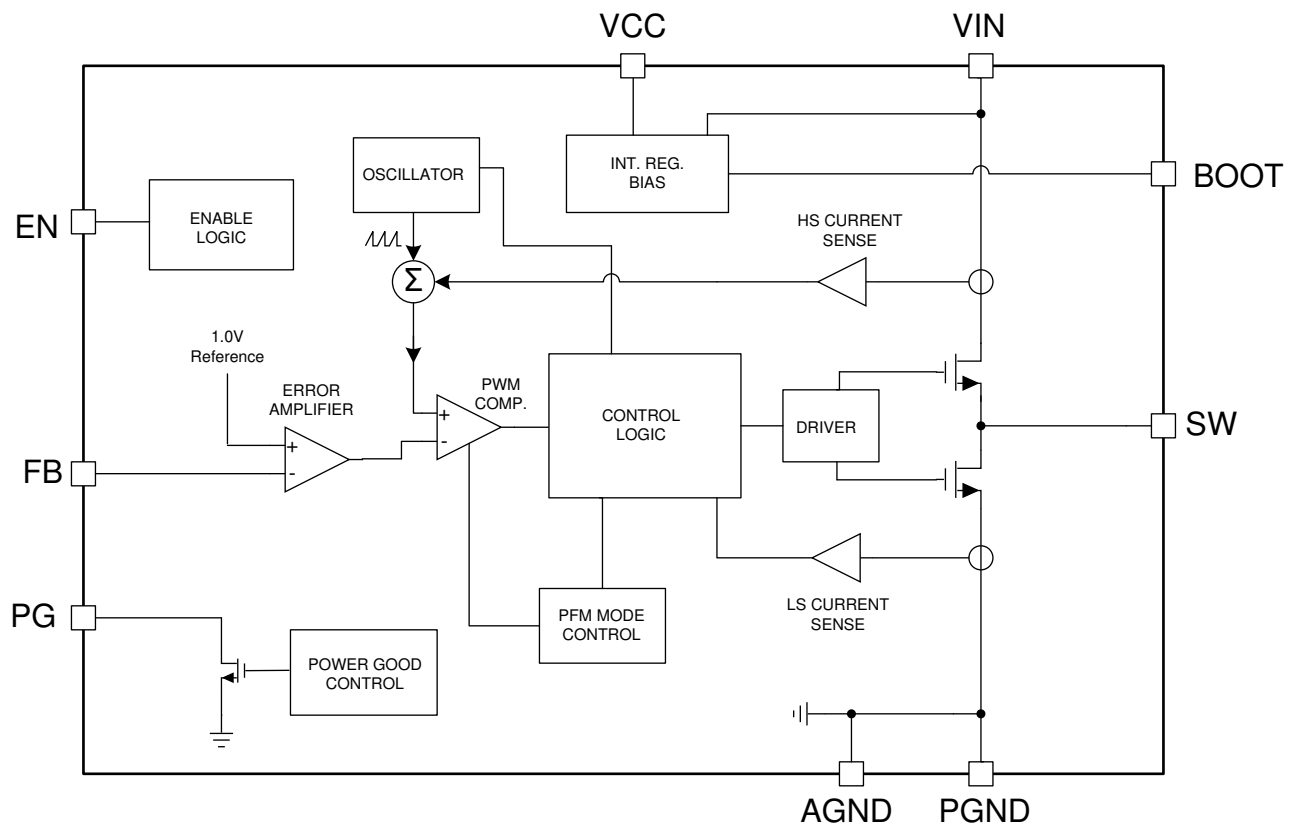

## 7.3 Feature Description

### 7.3.1 Power-Good Flag Output

The power-good flag function (PG output pin) of the LMR33630-Q1 can be used to reset a system microprocessor whenever the output voltage is out of regulation. This open-drain output goes low under fault conditions, such as current limit and thermal shutdown, as well as during normal start-up. A glitch filter prevents false flag operation for short excursions of the output voltage, such as during line and load transients. The timing parameters of the glitch filter are found in [Section 6.5](#). Output voltage excursions lasting less than  $t_{PG}$  do not trip the power-good flag. Power-good operation can best be understood by reference to [Figure 7-1](#) and [Figure 7-2](#). Note that during initial power up, a delay of about 4 ms (typical) is inserted from the time that EN is asserted to the time that the power-good flag goes high. This delay only occurs during start-up and is not encountered during normal operation of the power-good function.

The power-good output consists of an open-drain NMOS, requiring an external pullup resistor to a suitable logic supply. It can also be pulled up to either VCC or  $V_{OUT}$ , through a 100-k $\Omega$  resistor, as desired. If this function is not needed, the PG pin must be left floating. When EN is pulled low, the flag output is also forced low. With EN low, power good remains valid as long as the input voltage is  $\geq 2$  V (typical). Limit the current into the power-good flag pin to less than 5 mA D.C. The maximum current is internally limited to about 35 mA when the device is enabled and about 65 mA when the device is disabled. The internal current limit protects the device from any transient currents that can occur when discharging a filter capacitor connected to this output.

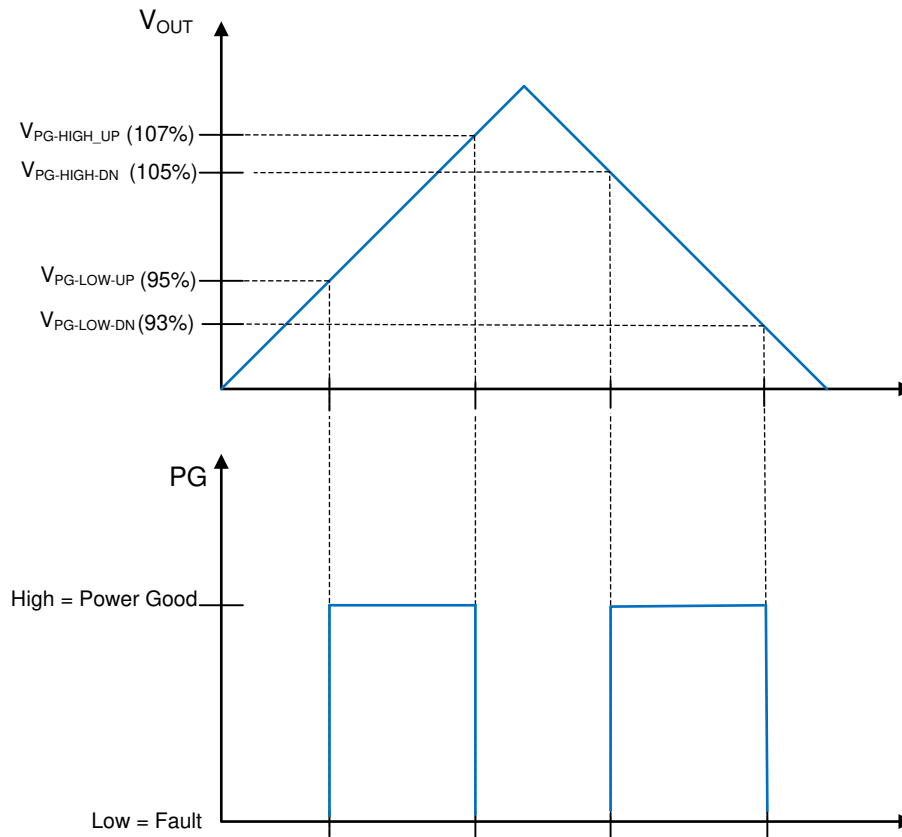

Figure 7-1. Static Power-Good Operation

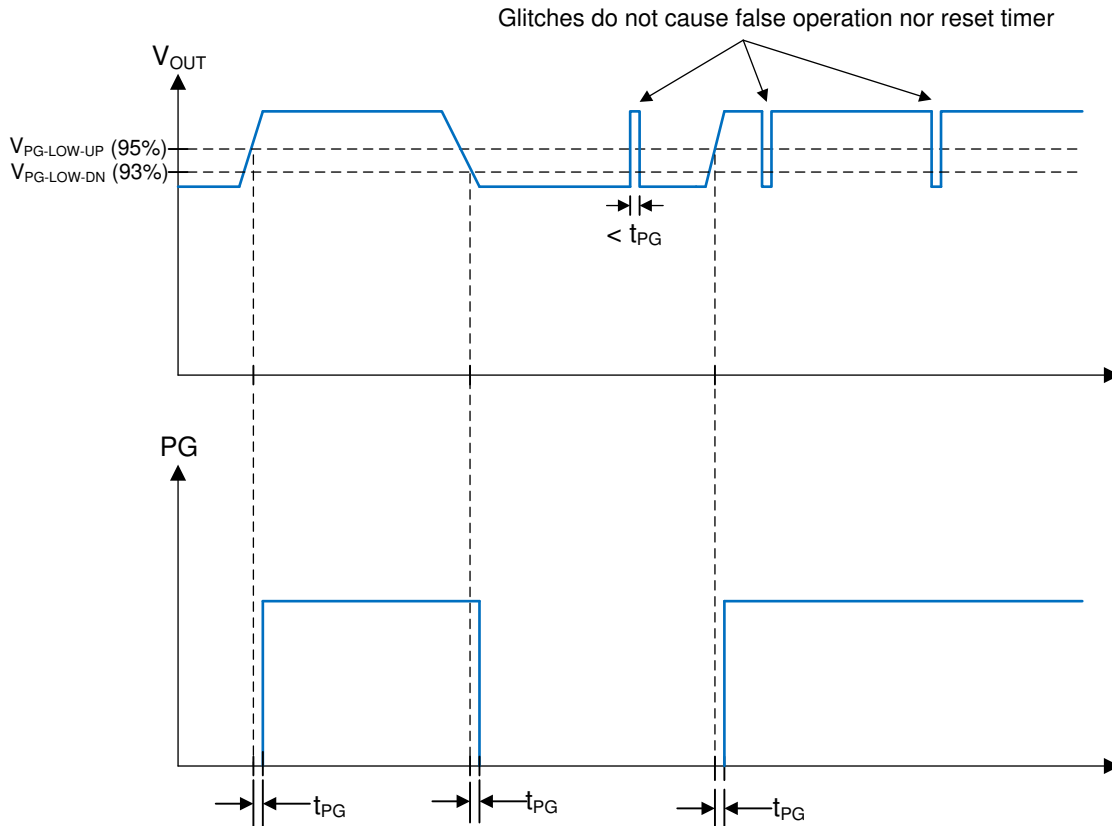
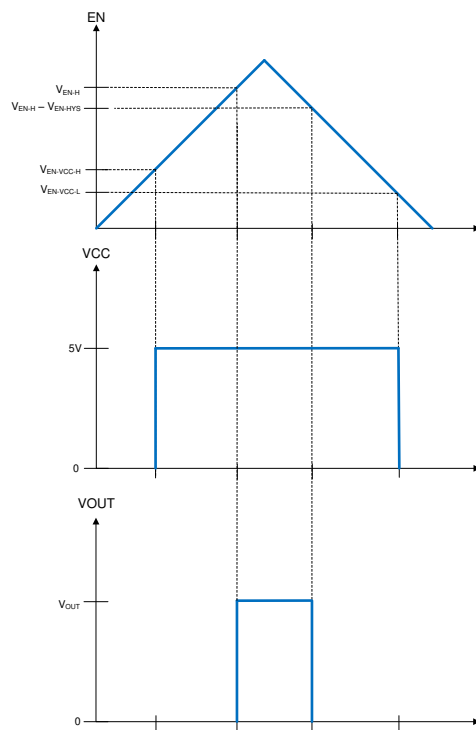

Figure 7-2. Power-Good-Timing Behavior

### 7.3.2 Enable and Start-up

Start-up and shutdown are controlled by the EN input. This input features precision thresholds, allowing the use of an external voltage divider to provide an adjustable input UVLO (see [Section 8.2.2.10](#)). Applying a voltage of  $\geq V_{EN-VCC\_H}$  causes the device to enter standby mode, powering the internal VCC, but not producing an output voltage. Increasing the EN voltage to  $V_{EN-H}$  fully enables the device, allowing it to enter start-up mode and start the soft-start period. When the EN input is brought below  $V_{EN-H}$  by  $V_{EN-HYS}$ , the regulator stops running and enters standby mode. Further decrease in the EN voltage to below  $V_{EN-VCC-L}$  completely shuts down the device. This behavior is shown in [Figure 7-3](#). The EN input can be connected directly to VIN if this feature is not needed. This input must not be allowed to float. The values for the various EN thresholds can be found in [Section 6.5](#).

The LMR33630-Q1 uses a reference-based soft start that prevents output voltage overshoots and large inrush currents as the regulator is starting up. A typical start-up waveform is shown in [Figure 7-4](#), indicating typical timings. The rise time of the output voltage is about 4 ms (see the [Section 6.5](#)).



**Figure 7-3. Precision Enable Behavior**

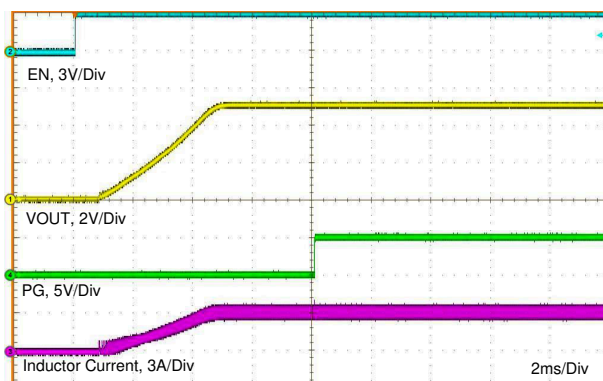

**Figure 7-4. Typical Start-up Behavior  $V_{IN} = 12\text{ V}$ ,  $V_{OUT} = 5\text{ V}$ ,  $I_{OUT} = 3\text{ A}$**

### 7.3.3 Current Limit and Short Circuit

The LMR33630-Q1 incorporates both peak and valley inductor current limit to provide protection to the device from overloads and short circuits and limit the maximum output current. Valley current limit prevents inductor current runaway during short circuits on the output, while both peak and valley limits work together to limit the maximum output current of the converter. Cycle-by-cycle current limit is used for overloads, while hiccup mode is used for sustained short circuits. Finally, a zero current detector is used on the low-side power MOSFET to implement DEM at light loads (see the [Glossary](#)). The typical value of this current limit is found under  $I_{ZC}$  in [Section 6.5](#).

When the device is overloaded, the valley of the inductor current may not reach below  $I_{LIMIT}$  (see [Section 6.5](#)) before the next clock cycle. When this occurs, the valley current limit control skips that cycle, causing the switching frequency to drop. Further overload causes the switching frequency to continue to drop, and the inductor ripple current to increase. When the peak of the inductor current reaches the high-side current limit,  $I_{SC}$

(see [Section 6.5](#)), the switch duty cycle is reduced and the output voltage falls out of regulation. This represents the maximum output current from the converter and is given approximately by [Equation 1](#).

$$I_{OUT}|_{max} = \frac{I_{LIMIT} + I_{SC}}{2} \quad (1)$$

If, during current limit, the voltage on the FB input falls below about 0.4 V due to a short circuit, the device enters hiccup mode. In this mode, the device stops switching for  $t_{HC}$  (see [Section 6.7](#)), or about 94 ms and then goes through a normal re-start with soft start. If the short-circuit condition remains, the device runs in current limit for about 20 ms (typical) and then shuts down again. This cycle repeats, as shown in [Figure 7-5](#) as long as the short-circuit-condition persists. This mode of operation helps reduce the temperature rise of the device during a hard short on the output. The output current is greatly reduced during hiccup mode. Once the output short is removed and the hiccup delay is passed, the output voltage recovers normally as shown in [Figure 7-6](#).

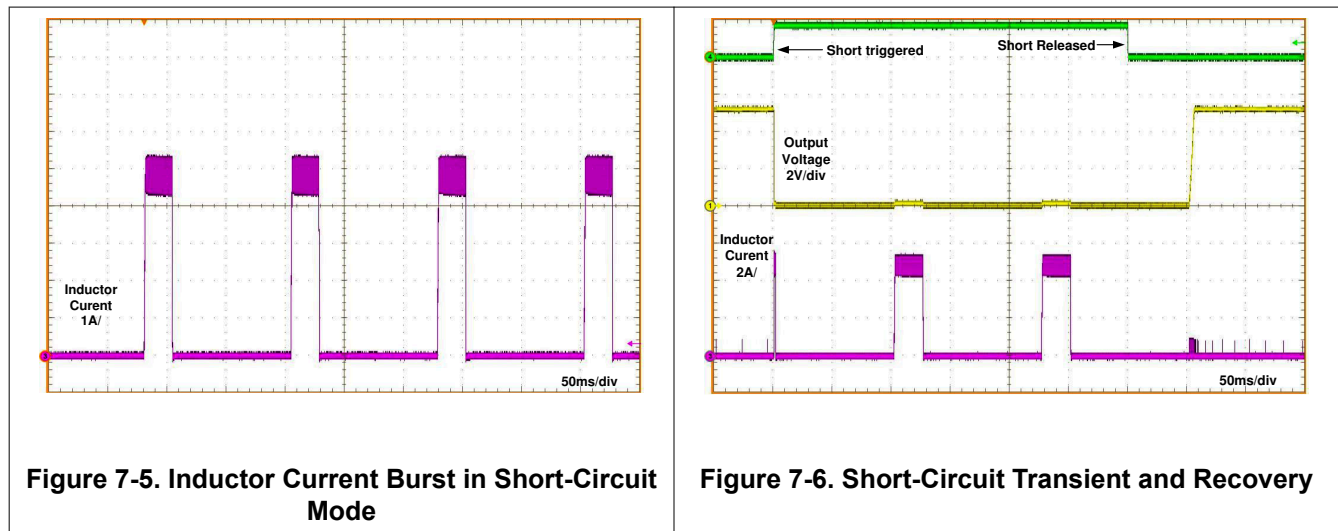

### 7.3.4 Undervoltage Lockout and Thermal Shutdown

The LMR33630-Q1 incorporates an undervoltage-lockout feature on the output of the internal LDO (at the VCC pin). When VCC reaches about 3.7 V, the device is ready to receive an EN signal and start up. When VCC falls below about 3 V, the device shuts down, regardless of EN status. Because the LDO is in dropout during these transitions, the above values roughly represent the input voltage levels during the transitions.

Thermal shutdown is provided to protect the regulator from excessive junction temperature. When the junction temperature reaches about 165°C, the device shuts down; re-start occurs when the temperature falls to about 148°C.

## 7.4 Device Functional Modes

### 7.4.1 Auto Mode

In auto mode, the device moves between PWM and PFM as the load changes. At light loads, the regulator operates in PFM. At higher loads, the mode changes to PWM. The load current for which the device moves from PFM to PWM can be found in [Section 8.2.3](#). The output current at which the device changes modes depends on the input voltage, inductor value, and the nominal switching frequency. For output currents above the curve, the device is in PWM mode. For currents below the curve, the device is in PFM. The curves apply for a nominal switching frequency of 400 kHz and the BOM shown in [Table 8-3](#). At higher switching frequencies, the load at which the mode change occurs is greater. For applications where the switching frequency must be known for a given condition, the transition between PFM and PWM must be carefully tested before the design is finalized.

In PWM mode, the regulator operates as a constant frequency converter using PWM to regulate the output voltage. While operating in this mode, the output voltage is regulated by switching at a constant frequency and

modulating the duty cycle to control the power to the load. This provides excellent line and load regulation and low output voltage ripple.

In PFM, the high-side MOSFET is turned on in a burst of one or more pulses to provide energy to the load. The duration of the burst depends on how long it takes the inductor current to reach  $I_{PEAK-MIN}$ . The periodicity of these bursts is adjusted to regulate the output, while diode emulation (DEM) is used to maximize efficiency (see the [Glossary](#)). This mode provides high light-load efficiency by reducing the amount of input supply current required to regulate the output voltage at light loads. PFM results in very good light-load efficiency, but also yields larger output voltage ripple and variable switching frequency. Also, a small increase in output voltage occurs at light loads. The actual switching frequency and output voltage ripple depends on the input voltage, output voltage, and load. Typical switching waveforms in PFM and PWM are shown in [Figure 7-7](#) and [Figure 7-8](#).

See [Section 8.2.3](#) for output voltage variation with load in auto mode.

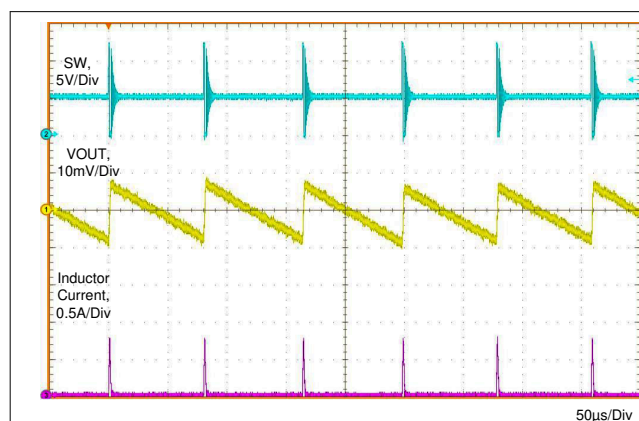

**Figure 7-7. Typical PFM Switching Waveforms  $V_{IN} = 12\text{ V}$ ,  $V_{OUT} = 5\text{ V}$ ,  $I_{OUT} = 10\text{ mA}$**

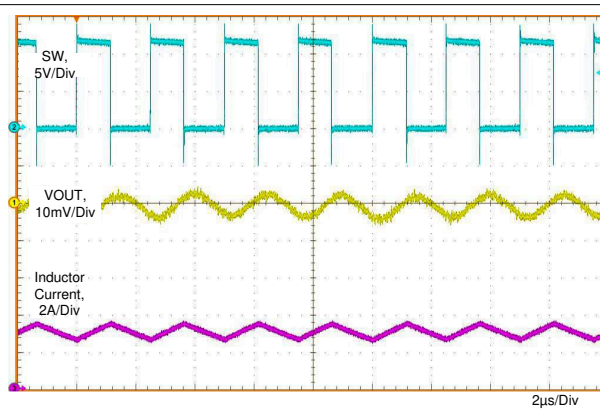

**Figure 7-8. Typical PWM Switching Waveforms  $V_{IN} = 12\text{ V}$ ,  $V_{OUT} = 5\text{ V}$ ,  $I_{OUT} = 3\text{ A}$ ,  $f_S = 400\text{ kHz}$**

## 7.4.2 Dropout

The dropout performance of any buck regulator is affected by the  $R_{DS(ON)}$  of the power MOSFETs, the DC resistance of the inductor, and the maximum duty cycle that the controller can achieve. As the input voltage level approaches the output voltage, the off-time of the high-side MOSFET starts to approach the minimum value (see [Section 6.6](#)). Beyond this point, the switching can become erratic, and the output voltage falls out of regulation. To avoid this problem, the LMR33630-Q1 automatically reduces the switching frequency to increase the effective duty cycle and maintain regulation. In this data sheet, the dropout voltage is defined as the difference between the input and output voltage when the output has dropped by 1% of its nominal value. Under this condition, the switching frequency has dropped to its minimum value of about 140 kHz. Note that the 0.4 V short circuit detection threshold is not activated when in dropout mode. Typical dropout characteristics can be found in [Figure 7-9](#), [Figure 7-10](#), [Figure 7-11](#), and [Figure 7-12](#).



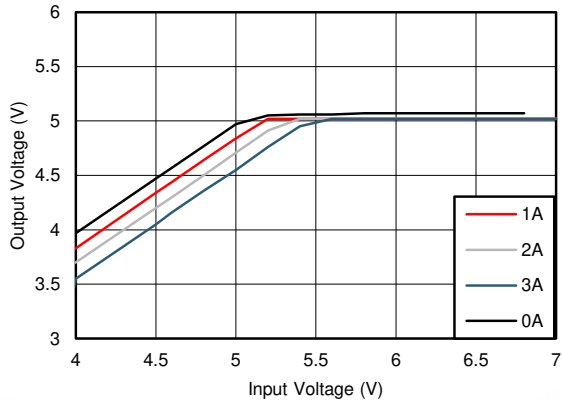

Figure 7-9. Overall Dropout Characteristic  $V_{OUT} = 5$  V

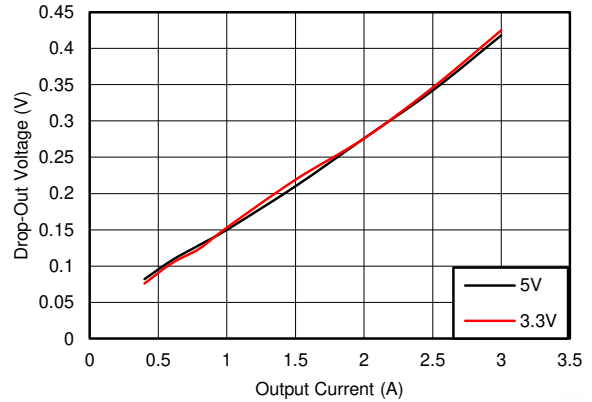

Figure 7-10. Typical Dropout Voltage versus Output Current in Frequency Foldback  $f_{SW} = 140$  kHz

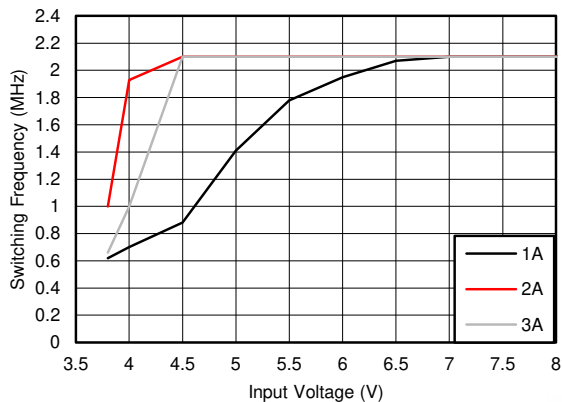

Figure 7-11. Typical Switching Frequency in Dropout Mode  $V_{OUT} = 3.3$  V,  $f_{SW} = 2.1$  MHz

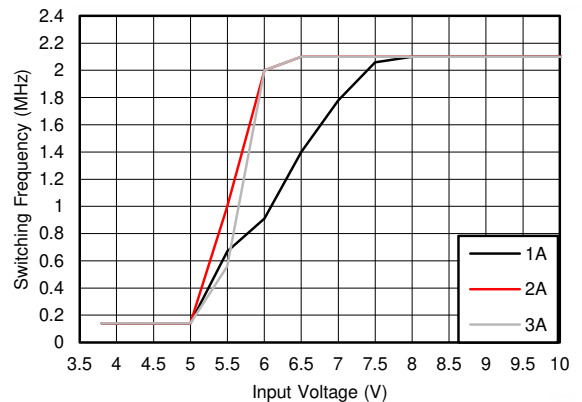
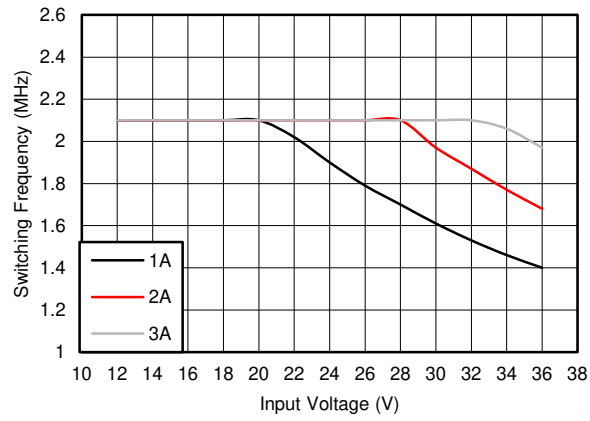

Figure 7-12. Typical Switching Frequency in Dropout Mode  $V_{OUT} = 5$  V,  $f_{SW} = 2.1$  MHz

### 7.4.3 Minimum Switch On-Time

Every switching regulator has a minimum controllable on-time dictated by the inherent delays and blanking times associated with the control circuits. This imposes a minimum switch duty cycle and, therefore, a minimum conversion ratio. The constraint is encountered at high input voltages and low output voltages. To help extend the minimum controllable duty cycle, the LMR33630-Q1 automatically reduces the switching frequency when the minimum on-time limit is reached. This way the converter can regulate the lowest programmable output voltage at the maximum input voltage. An estimate for the approximate input voltage, for a given output voltage, before frequency foldback occurs is found in Equation 2. The values of  $t_{ON}$  and  $f_{SW}$  can be found in Section 6.5. As the input voltage is increased, the switch on-time (duty-cycle) reduces to regulate the output voltage. When the on-time reaches the limit, the switching frequency drops, while the on-time remains fixed. This relationship is highlighted in Figure 7-13 for a nominal switching frequency of 2.1 MHz.

$$V_{IN} \leq \frac{V_{OUT}}{t_{ON} \cdot f_{SW}} \quad (2)$$



**Figure 7-13. Switching Frequency versus Input Voltage  $V_{OUT} = 3.3\text{ V}$**

## 8 Application and Implementation

---

### Note

Information in the following applications sections is not part of the TI component specification, and TI does not warrant its accuracy or completeness. TI's customers are responsible for determining suitability of components for their purposes. Customers should validate and test their design implementation to confirm system functionality.

---

### 8.1 Application Information

The LMR33630-Q1 step-down DC-to-DC converter is typically used to convert a higher DC voltage to a lower DC voltage with a maximum output current of 3 A. The following design procedure can be used to select components for the LMR33630-Q1. Alternately, the WEBENCH Design Tool can be used to generate a complete design. This tool utilizes an iterative design procedure and has access to a comprehensive database of components. This allows the tool to create an optimized design and allows the user to experiment with various options.

---

### Note

In this data sheet, the *effective* value of capacitance is defined as the actual capacitance under D.C. bias and temperature; not the rated or nameplate values. Use high-quality, low-ESR, ceramic capacitors with an X5R or better dielectric throughout. All high value ceramic capacitors have a large voltage coefficient in addition to normal tolerances and temperature effects. Under D.C. bias the capacitance drops considerably. Large case sizes and/or higher voltage ratings are better in this regard. To help mitigate these effects, multiple capacitors can be used in parallel to bring the minimum *effective* capacitance up to the required value. This can also ease the RMS current requirements on a single capacitor. A careful study of bias and temperature variation of any capacitor bank should be made in order to ensure that the minimum value of *effective* capacitance is provided.

---

### 8.2 Typical Application

[Figure 8-1](#) shows a typical application circuit for the LMR33630-Q1. This device is designed to function over a wide range of external components and system parameters. However, the internal compensation is optimized for a certain range of external inductance and output capacitance. As a quick start guide, [Figure 8-1](#) provide typical component values for a range of the most common output voltages. The values given in the table are typical. Other values can be used to enhance certain performance criterion as required by the application. Note that for the VQFN package, the input capacitors are split and placed on either side of the package; see [Section 8.2.2.6](#) for more details.

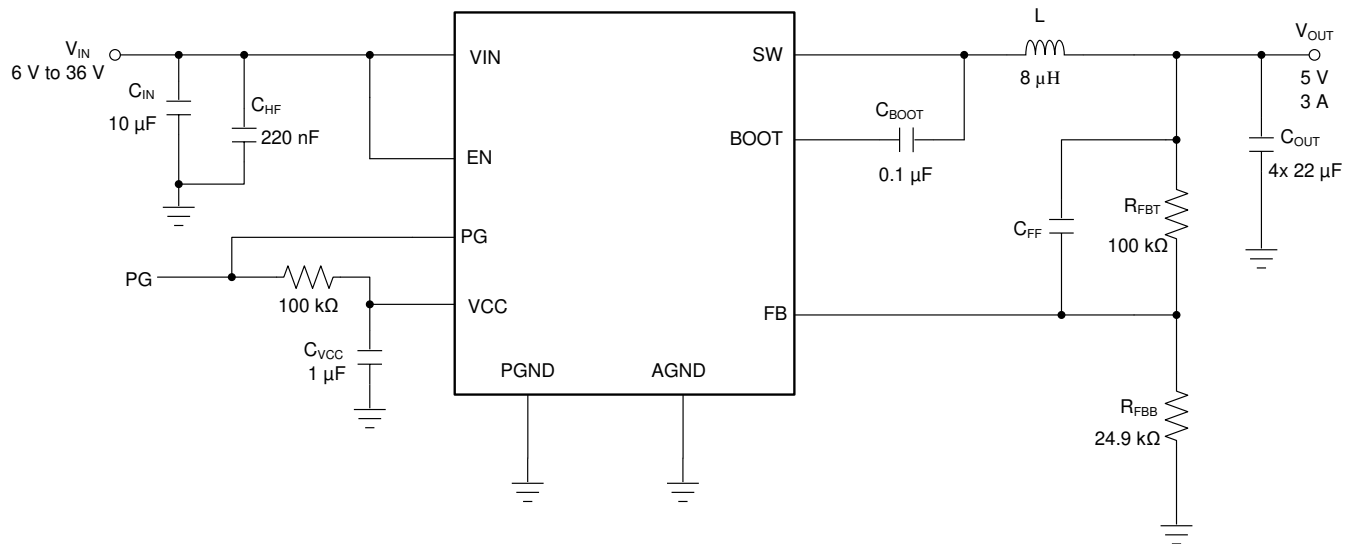

Figure 8-1. Example Application Circuit (400 kHz)

## 8.2.1 Design Requirements

Table 8-1 provides the parameters for our detailed design procedure example:

Table 8-1. Detailed Design Parameters

DESIGN PARAMETER	EXAMPLE VALUE
Input voltage	12 V (6 V to 36 V)
Output voltage	5 V
Maximum output current	0 A to 3 A
Switching frequency	400 kHz

Table 8-2. Typical External Component Values

$f_{sw}$ (kHz)	$V_{OUT}$ (V)	L ( $\mu$ H)	$C_{OUT}$ (RATED CAPACITANCE)	$R_{FBT}$ ( $\Omega$ )	$R_{FBB}$ ( $\Omega$ )	$C_{IN} + C_{HF}$	$C_{BOOT}$	$C_{VCC}$	$C_{FF}$
400	3.3	6.8	4 × 22 $\mu$ F	100 k	43.2 k	10 $\mu$ F + 220 nF	100 nF	1 $\mu$ F	open
1400	3.3	2.2	2 × 22 $\mu$ F	100 k	43.2 k	10 $\mu$ F + 220 nF	100 nF	1 $\mu$ F	open
2100	3.3	1.2	2 × 22 $\mu$ F	100 k	43.2 k	10 $\mu$ F + 220 nF	100 nF	1 $\mu$ F	open
400	5	8	4 × 22 $\mu$ F	100 k	24.9 k	10 $\mu$ F + 220 nF	100 nF	1 $\mu$ F	open
1400	5	2.2	2 × 22 $\mu$ F	100 k	24.9 k	10 $\mu$ F + 220 nF	100 nF	1 $\mu$ F	open
2100	5	1.5	2 × 22 $\mu$ F	100 k	24.9 k	10 $\mu$ F + 220 nF	100 nF	1 $\mu$ F	open
400	12	15	4 × 22 $\mu$ F	100 k	9.09 k	10 $\mu$ F + 220 nF	100 nF	1 $\mu$ F	open
1400	12	4.7	4 × 10 $\mu$ F	100 k	9.09 k	10 $\mu$ F + 220 nF	100 nF	1 $\mu$ F	open
2100	12	3.3	4 × 10 $\mu$ F	100 k	9.09 k	10 $\mu$ F + 220 nF	100 nF	1 $\mu$ F	open

## 8.2.2 Detailed Design Procedure

The following design procedure applies to Figure 8-1 and Table 8-1.

### 8.2.2.1 Custom Design With WEBENCH® Tools

[Click here](#) to create a custom design using the LMR33630-Q1 device with the WEBENCH® Power Designer.

1. Start by entering the input voltage ( $V_{IN}$ ), output voltage ( $V_{OUT}$ ), and output current ( $I_{OUT}$ ) requirements.
2. Optimize the design for key parameters such as efficiency, footprint, and cost using the optimizer dial.
3. Compare the generated design with other possible solutions from Texas Instruments.

The WEBENCH Power Designer provides a customized schematic along with a list of materials with real-time pricing and component availability.

In most cases, these actions are available:

- Run electrical simulations to see important waveforms and circuit performance
- Run thermal simulations to understand board thermal performance
- Export customized schematic and layout into popular CAD formats
- Print PDF reports for the design, and share the design with colleagues

Get more information about WEBENCH tools at [www.ti.com/WEBENCH](http://www.ti.com/WEBENCH).

### 8.2.2.2 Choosing the Switching Frequency

The choice of switching frequency is a compromise between conversion efficiency and overall solution size. Lower switching frequency implies reduced switching losses and usually results in higher system efficiency. However, higher switching frequency allows the use of smaller inductors and output capacitors, and hence a more compact design. For this example, 400 kHz was chosen.

### 8.2.2.3 Setting the Output Voltage

The output voltage of the LMR33630-Q1 is externally adjustable using a resistor divider network. The range of recommended output voltage is found in [Section 6.3](#). The divider network is comprised of  $R_{FBT}$  and  $R_{FBB}$ , and closes the loop between the output voltage and the converter. The converter regulates the output voltage by holding the voltage on the FB pin equal to the internal reference voltage,  $V_{REF}$ . The resistance of the divider is a compromise between excessive noise pick-up and excessive loading of the output. Smaller values of resistance reduce noise sensitivity but also reduce the light-load efficiency. The recommended value for  $R_{FBT}$  is 100 k $\Omega$ ; with a maximum value of 1 M $\Omega$ . If a 1 M $\Omega$  is selected for  $R_{FBT}$ , then a feedforward capacitor must be used across this resistor to provide adequate loop phase margin (see [Section 8.2.2.9](#)). Once  $R_{FBT}$  is selected, [Equation 3](#) is used to select  $R_{FBB}$ .  $V_{REF}$  is nominally 1 V (see [Section 6.5](#) for limits).

$$R_{FBB} = \frac{R_{FBT}}{\left[ \frac{V_{OUT}}{V_{REF}} - 1 \right]} \quad (3)$$

For this 5-V example,  $R_{FBT} = 100 \text{ k}\Omega$  and  $R_{FBB} = 24.9 \text{ k}\Omega$  are chosen.

### 8.2.2.4 Inductor Selection

The parameters for selecting the inductor are the inductance and saturation current. The inductance is based on the desired peak-to-peak ripple current and is normally chosen to be in the range of 20% to 40% of the maximum output current. Experience shows that the best value for inductor ripple current is 30% of the maximum load current. Note that when selecting the ripple current for applications with much smaller maximum load than the maximum available from the device, the maximum device current should be used. [Equation 4](#) can be used to determine the value of inductance. The constant K is the percentage of inductor current ripple. For this example,  $K = 0.3$  was chosen and an inductance  $L = 8.1 \text{ }\mu\text{H}$  was found; the next standard value of 8  $\mu\text{H}$  was selected.

$$L = \frac{(V_{IN} - V_{OUT})}{f_{SW} \cdot K \cdot I_{OUT\max}} \cdot \frac{V_{OUT}}{V_{IN}} \quad (4)$$

Ideally, the saturation current rating of the inductor must be at least as large as the high-side switch current limit,  $I_{SC}$  (see [Section 6.5](#)). This ensures that the inductor does not saturate even during a short circuit on the output. When the inductor core material saturates, the inductance falls to a very low value, causing the inductor current to rise very rapidly. Although the valley current limit,  $I_{LIMIT}$ , is designed to reduce the risk of current run-away, a saturated inductor can cause the current to rise to high values very rapidly. This can lead to component damage; do not allow the inductor to saturate. Inductors with a ferrite core material have very *hard* saturation characteristics, but usually have lower core losses than powdered iron cores. Powered iron cores exhibit a *soft*

saturation, allowing for some relaxation in the current rating of the inductor. However, they have more core losses at frequencies typically above 1 MHz. In any case, the inductor saturation current must not be less than the device low-side current limit,  $I_{LIMIT}$  (see the [Section 6.5](#)). The maximum inductance is limited by the minimum current ripple required for the current mode control to perform correctly. As a rule-of-thumb, the minimum inductor ripple current must be no less than about 10% of the device maximum rated current under nominal conditions.

$$L_{MIN} \geq 0.28 \cdot \frac{V_{OUT}}{f_{SW}} \quad (5)$$

### 8.2.2.5 Output Capacitor Selection

The value of the output capacitor and the ESR of the capacitor determine the output voltage ripple and load transient performance. The output capacitor bank is usually limited by the load transient requirements, rather than the output voltage ripple. [Equation 6](#) can be used to estimate a lower bound on the total output capacitance and an upper bound on the ESR, which is required to meet a specified load transient.

$$C_{OUT} \geq \frac{\Delta I_{OUT}}{f_{SW} \cdot \Delta V_{OUT} \cdot K} \cdot \left[ (1-D) \cdot (1+K) + \frac{K^2}{12} \cdot (2-D) \right]$$

$$ESR \leq \frac{(2+K) \cdot \Delta V_{OUT}}{2 \cdot \Delta I_{OUT} \left[ 1+K + \frac{K^2}{12} \cdot \left( 1 + \frac{1}{(1-D)} \right) \right]}$$

$$D = \frac{V_{OUT}}{V_{IN}} \quad (6)$$

where

- $\Delta V_{OUT}$  = output voltage transient
- $\Delta I_{OUT}$  = output current transient
- $K$  = ripple factor from [Section 8.2.2.4](#)

Once the output capacitor and ESR have been calculated, [Equation 7](#) can be used to check the peak-to-peak output voltage ripple;  $V_r$ .

$$V_r \cong \Delta I_L \cdot \sqrt{ESR^2 + \frac{1}{(8 \cdot f_{SW} \cdot C_{OUT})^2}} \quad (7)$$

The output capacitor and ESR can then be adjusted to meet both the load transient and output ripple requirements.

For this example, a  $\Delta V_{OUT} \leq 250$  mV for an output current step of  $\Delta I_{OUT} = 2$  A is required. [Equation 6](#) gives a minimum value of 52  $\mu$ F and a maximum ESR of 0.11  $\Omega$ . Assuming a 20% tolerance and a 10% bias de-rating, you arrive at a minimum capacitance of 72  $\mu$ F. This can be achieved with a bank of 4  $\times$  22- $\mu$ F, 16-V ceramic capacitors in the 1210 case size. More output capacitance can be used to improve the load transient response. Ceramic capacitors can easily meet the minimum ESR requirements. In some cases, an aluminum electrolytic capacitor can be placed in parallel with the ceramics to help build up the required value of capacitance. In general, use a capacitor of at least 10 V for output voltages of 3.3 V or less and a capacitor of 16 V or more for output voltages of 5 V and above.

In practice, the output capacitor has the most influence on the transient response and loop phase margin. Load transient testing and Bode plots are the best way to validate any given design and must always be completed before the application goes into production. In addition to the required output capacitance, a small ceramic

placed on the output can help reduce high frequency noise. Small case size ceramic capacitors in the range of 1 nF to 100 nF can be very helpful in reducing voltage spikes on the output caused by inductor and board parasitics.

The maximum value of total output capacitance must be limited to about 10 times the design value, or 1000  $\mu$ F, whichever is smaller. Large values of output capacitance can adversely affect the start-up behavior of the regulator as well as the loop stability. If values larger than noted here must be used, then a careful study of start-up at full load and loop stability must be performed.

### 8.2.2.6 Input Capacitor Selection

The ceramic input capacitors provide a low impedance source to the regulator in addition to supplying the ripple current and isolating switching noise from other circuits. A minimum of 10  $\mu$ F of ceramic capacitance is required on the input of the LMR33630-Q1. This must be rated for at least the maximum input voltage that the application requires; preferably twice the maximum input voltage. This capacitance can be increased to help reduce input voltage ripple and maintain the input voltage during load transients. In addition, a small case size, 220-nF ceramic capacitor must be used at the input, as close as possible to the regulator. This provides a high frequency bypass for the control circuits internal to the device. For this example, a 4.7- $\mu$ F, 50-V, X7R (or better) ceramic capacitor is chosen. The 220 nF must also be rated at 50 V with an X7R dielectric. The VQFN (RNX) package provides two input voltage pins and two power ground pins on opposite sides of the package. This allows the input capacitors to be split, and placed optimally with respect to the internal power MOSFETs, thus improving the effectiveness of the input bypassing. In this example, a single 4.7- $\mu$ F and two 100-nF ceramic capacitors at each VIN/PGND location.

Many times, it is desirable to use an electrolytic capacitor on the input in parallel with the ceramics. This is especially true if long leads/traces are used to connect the input supply to the regulator. The moderate ESR of this capacitor can help damp any ringing on the input supply caused by the long power leads. The use of this additional capacitor also helps with momentary voltage dips caused by input supplies with unusually high impedance.

Most of the input switching current passes through the ceramic input capacitor or capacitors. The approximate worst case RMS value of this current can be calculated from [Equation 8](#) and must be checked against the manufacturers' maximum ratings.

$$I_{\text{RMS}} \cong \frac{I_{\text{OUT}}}{2} \quad (8)$$

### 8.2.2.7 C<sub>BOOT</sub>

The LMR33630-Q1 requires a bootstrap capacitor connected between the BOOT pin and the SW pin. This capacitor stores energy that is used to supply the gate drivers for the power MOSFETs. A high-quality ceramic capacitor of 100 nF and at least 10 V is required.

### 8.2.2.8 VCC

The VCC pin is the output of the internal LDO used to supply the control circuits of the regulator. This output requires a 1- $\mu$ F, 16-V ceramic capacitor connected from VCC to GND for proper operation. In general, avoid loading this output with any external circuitry. However, this output can be used to supply the pullup for the power-good function (see [Section 7.3.1](#)). A value of 100 k $\Omega$  is a good choice in this case. The nominal output voltage on VCC is 5 V; see [Section 6.5](#) for limits. Do not short this output to ground or any other external voltage.

### 8.2.2.9 C<sub>FF</sub> Selection

In some cases, a feedforward capacitor can be used across R<sub>F<sub>BT</sub></sub> to improve the load transient response or improve the loop-phase margin. This is especially true when values of R<sub>F<sub>BT</sub></sub> > 100 k $\Omega$  are used. Large values of R<sub>F<sub>BT</sub></sub>, in combination with the parasitic capacitance at the FB pin, can create a small signal pole that interferes with the loop stability. A C<sub>FF</sub> can help to mitigate this effect. [Equation 9](#) can be used to estimate the value of C<sub>FF</sub>. The value found with [Equation 9](#) is a starting point; use lower values to determine if any advantage is gained by the use of a C<sub>FF</sub> capacitor. The [Optimizing Transient Response of Internally Compensated DC-DC Converters with Feed-forward Capacitor Application Report](#) is helpful when experimenting with a feedforward capacitor.

$$C_{FF} < \frac{V_{OUT} \cdot C_{OUT}}{120 \cdot R_{FBT} \cdot \sqrt{\frac{V_{REF}}{V_{OUT}}}} \quad (9)$$

### 8.2.2.10 External UVLO

In some cases, an input UVLO level different than that provided internal to the device is needed. This can be accomplished by using the circuit shown in [Figure 8-2](#). The input voltage at which the device turns on is designated  $V_{ON}$  while the turnoff voltage is  $V_{OFF}$ . First, a value for  $R_{ENB}$  is chosen in the range of 10 k $\Omega$  to 100 k $\Omega$  and then [Equation 10](#) is used to calculate  $R_{ENT}$  and  $V_{OFF}$ .

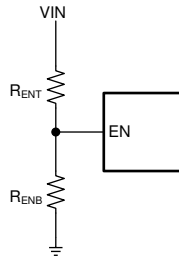

**Figure 8-2. Setup for External UVLO Application**

$$R_{ENT} = \left( \frac{V_{ON}}{V_{EN-H}} - 1 \right) \cdot R_{ENB}$$

$$V_{OFF} = V_{ON} \cdot \left( 1 - \frac{V_{EN-HYS}}{V_{EN-H}} \right) \quad (10)$$

where

- $V_{ON} = V_{IN}$  turnon voltage
- $V_{OFF} = V_{IN}$  turnoff voltage

### 8.2.2.11 Maximum Ambient Temperature

As with any power conversion device, the LMR33630-Q1 dissipates internal power while operating. The effect of this power dissipation is to raise the internal temperature of the converter above ambient. The internal die temperature ( $T_J$ ) is a function of the ambient temperature, the power loss, and the effective thermal resistance,  $R_{\theta JA}$ , of the device and PCB combination. The maximum internal die temperature for the LMR33630-Q1 must be limited to 125°C. This establishes a limit on the maximum device power dissipation and therefore the load current. [Equation 11](#) shows the relationships between the important parameters. It is easy to see that larger ambient temperatures ( $T_A$ ) and larger values of  $R_{\theta JA}$  reduce the maximum available output current. The converter efficiency can be estimated by using the curves provided in this data sheet. If the desired operating conditions cannot be found in one of the curves, then interpolation can be used to estimate the efficiency. Alternatively, the EVM can be adjusted to match the desired application requirements and the efficiency can be measured directly. The correct value of  $R_{\theta JA}$  is more difficult to estimate. As stated in the [Semiconductor and IC Package Thermal Metrics Application Report](#), the value of  $R_{\theta JA}$  given in [Section 6.4](#) is not valid for design purposes and must not be used to estimate the thermal performance of the application. The values reported in that table were measured under a specific set of conditions that are rarely obtained in an actual application.

$$I_{OUT}|_{MAX} = \frac{(T_J - T_A)}{R_{\theta JA}} \cdot \frac{\eta}{(1 - \eta)} \cdot \frac{1}{V_{OUT}} \quad (11)$$

where

- $\eta$  = efficiency





### 8.2.3 Application Curves

Unless otherwise specified the following conditions apply:  $V_{IN} = 12\text{ V}$ ,  $T_A = 25^\circ\text{C}$ . The circuit is shown in [Figure 8-29](#), with the appropriate BOM from [Table 8-3](#).

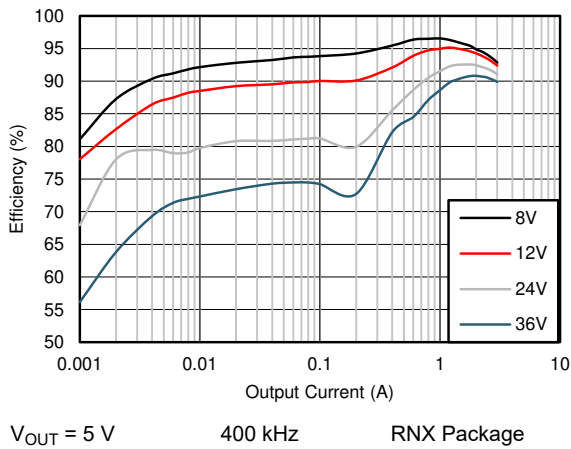

**Figure 8-5. Efficiency**

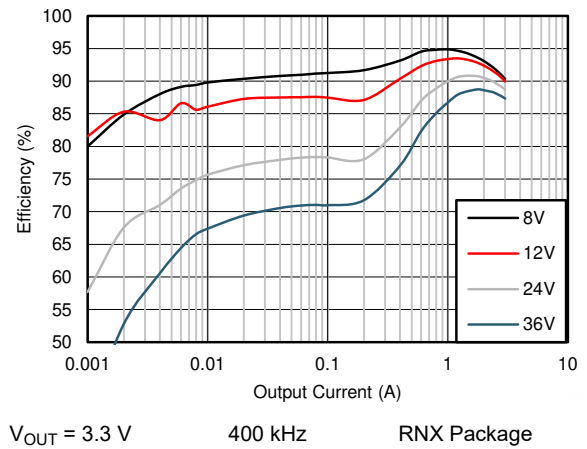

**Figure 8-6. Efficiency**

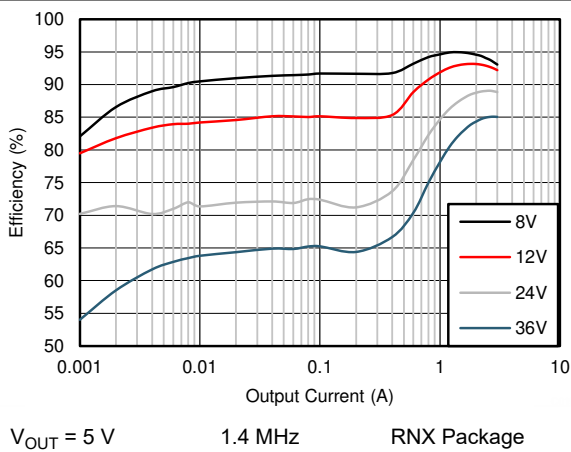

**Figure 8-7. Efficiency**

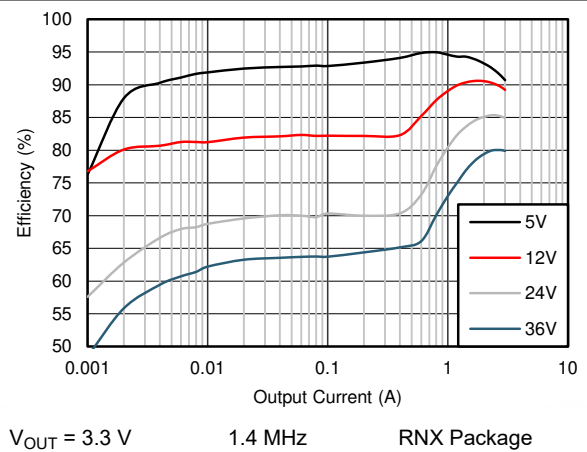

**Figure 8-8. Efficiency**

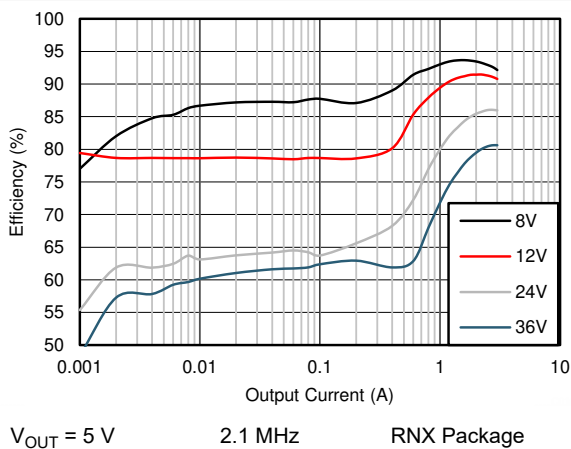

**Figure 8-9. Efficiency**

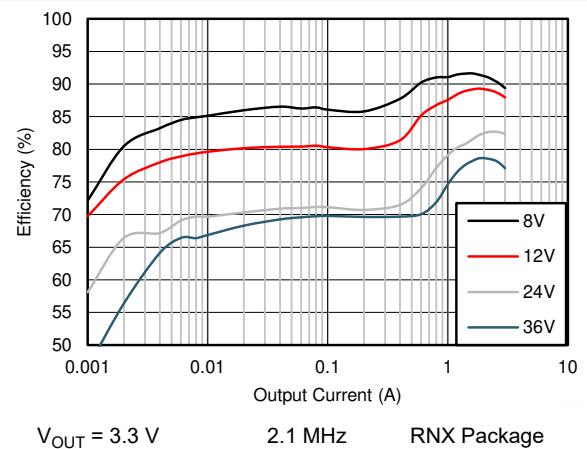

**Figure 8-10. Efficiency**

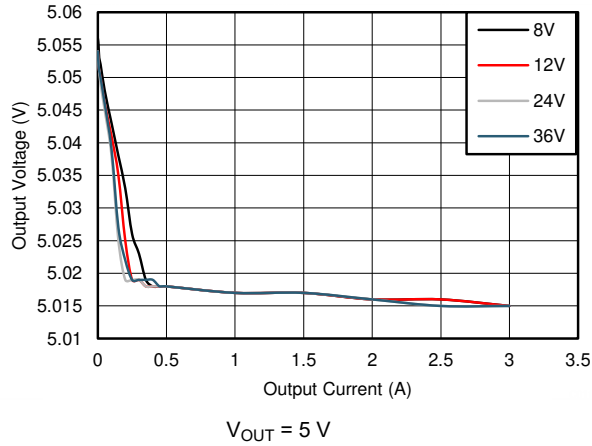

Figure 8-11. Line and Load Regulation

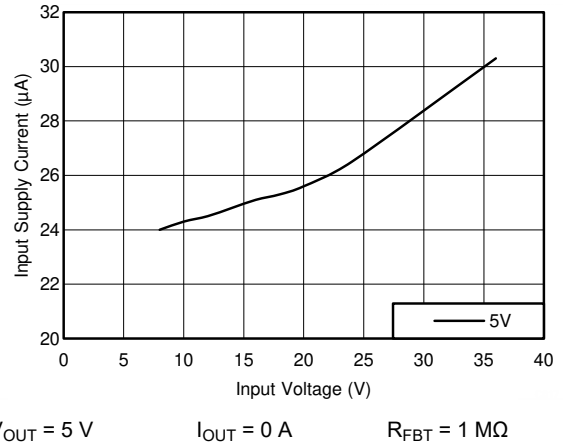

Figure 8-12. Input Supply Current

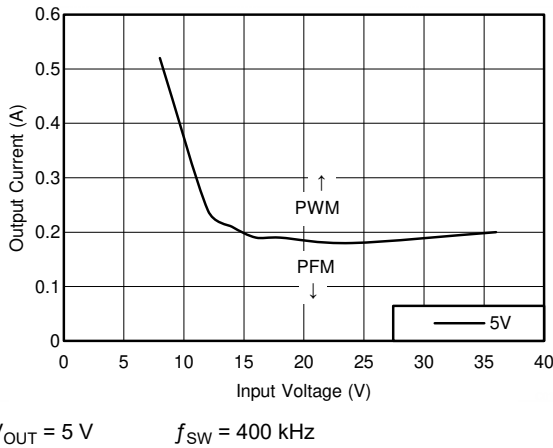

Figure 8-13. Mode Change Thresholds

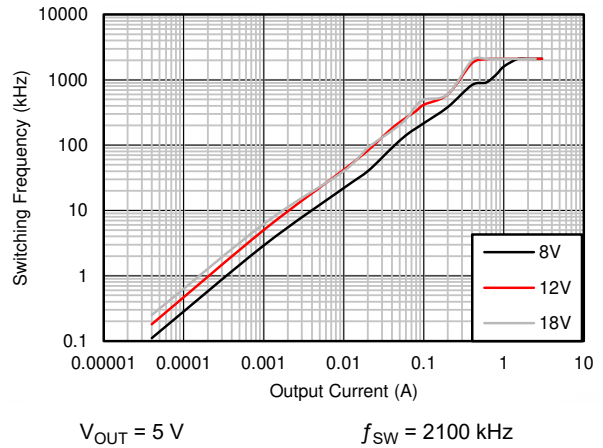

Figure 8-14. Switching Frequency versus Output Current

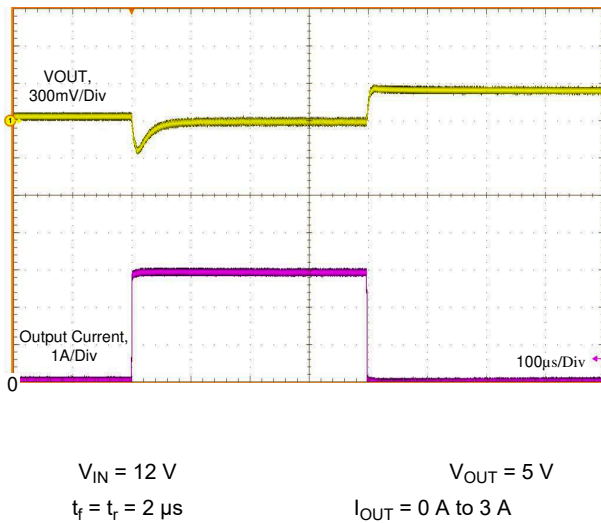

Figure 8-15. Load Transient

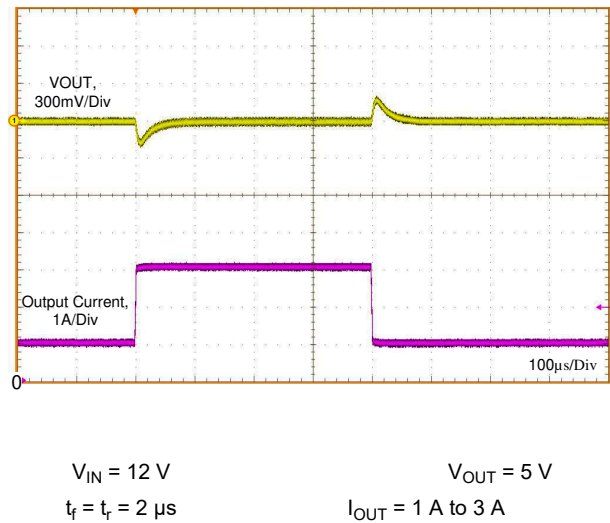
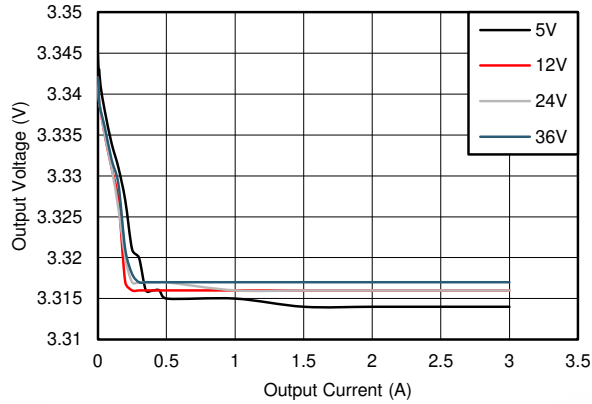
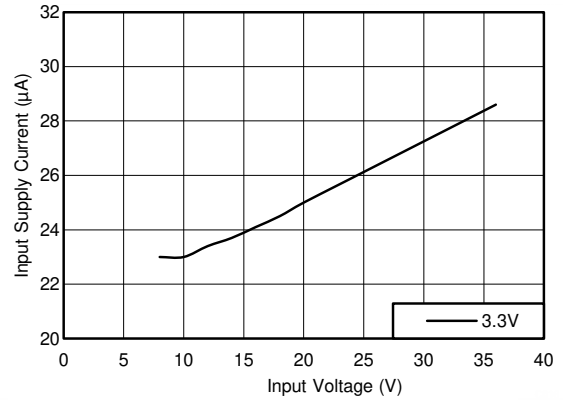

Figure 8-16. Load Transient



$V_{OUT} = 3.3\text{ V}$

**Figure 8-17. Line and Load Regulation**



$V_{OUT} = 3.3\text{ V}$        $I_{OUT} = 0\text{ A}$        $R_{FBT} = 1\text{ M}\Omega$

**Figure 8-18. Input Supply Current**

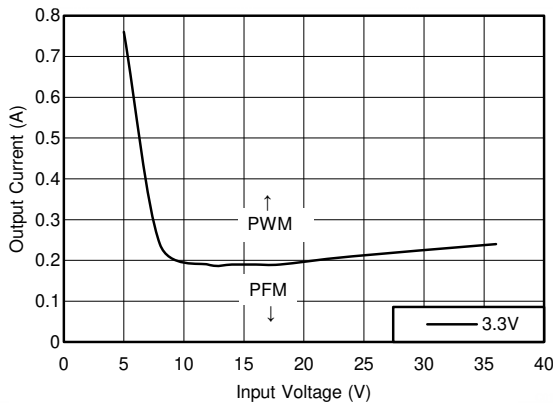

$V_{OUT} = 3.3\text{ V}$        $f_{SW} = 400\text{ kHz}$

**Figure 8-19. Mode Change Thresholds**

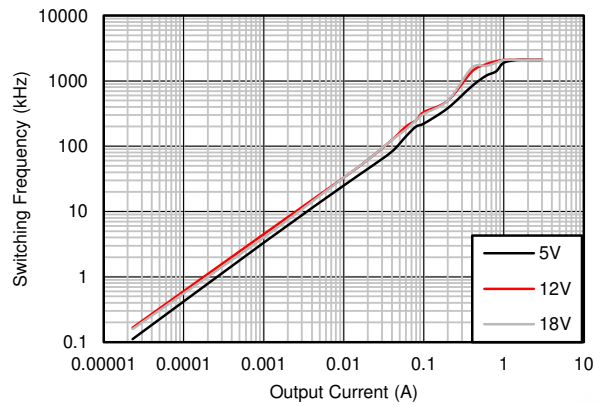

A.  $V_{OUT} = 3.3\text{ V}$        $f_{SW} = 2100\text{ kHz}$

**Figure 8-20. Switching Frequency versus Output Current**

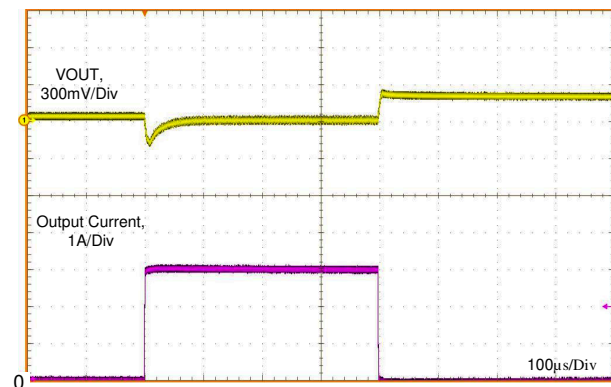

$V_{IN} = 12\text{ V}$        $V_{OUT} = 3.3\text{ V}$   
 $t_f = t_r = 2\text{ }\mu\text{s}$        $I_{OUT} = 0\text{ A to } 3\text{ A}$

**Figure 8-21. Load Transient**

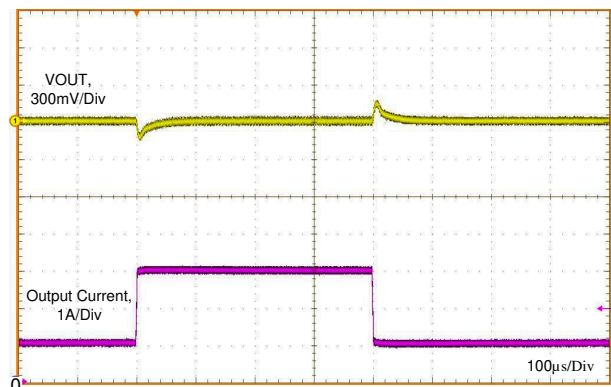

$V_{IN} = 12\text{ V}$        $V_{OUT} = 3.3\text{ V}$        $I_{OUT} = 1\text{ A to } 3\text{ A}$   
 $t_f = t_r = 2\text{ }\mu\text{s}$

**Figure 8-22. Load Transient**

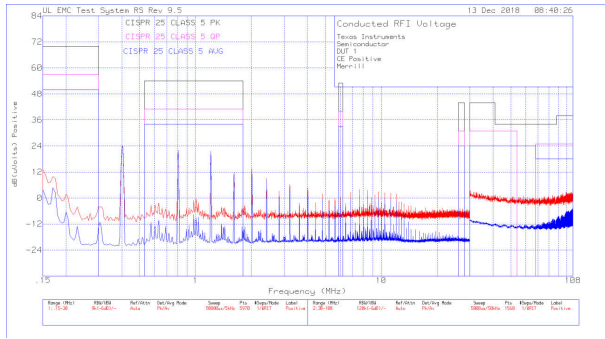

$V_{IN} = 12\text{ V}$        $V_{OUT} = 5\text{ V}$        $I_{OUT} = 3\text{ A}$   
 $f_{SW} = 400\text{ kHz}$       RNX package

**Figure 8-23. Conducted EMI**

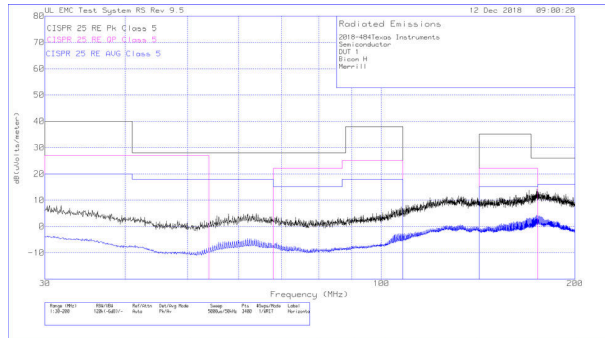

$V_{IN} = 12\text{ V}$        $V_{OUT} = 5\text{ V}$        $I_{OUT} = 3\text{ A}$   
 $f_{SW} = 400\text{ kHz}$       RNX package

**Figure 8-24. Radiated EMI Biconical Antenna (Horizontal)**

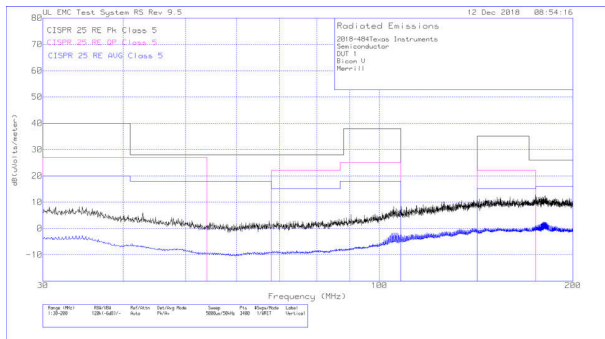

$V_{IN} = 12\text{ V}$        $V_{OUT} = 5\text{ V}$        $I_{OUT} = 3\text{ A}$   
 $f_{SW} = 400\text{ kHz}$       RNX package

**Figure 8-25. Radiated EMI Biconical Antenna (Vertical)**

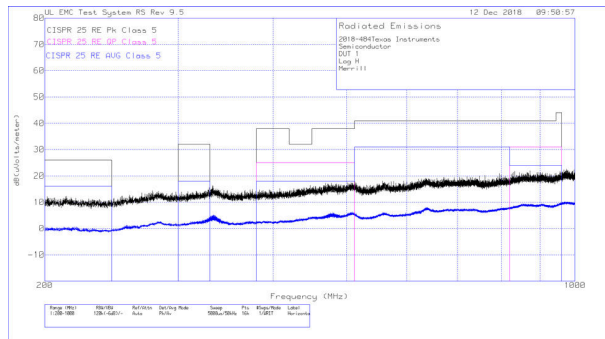

$V_{IN} = 12\text{ V}$        $V_{OUT} = 5\text{ V}$        $I_{OUT} = 3\text{ A}$   
 $f_{SW} = 400\text{ kHz}$       RNX package

**Figure 8-26. Radiated EMI Log-periodic Antenna (Horizontal)**

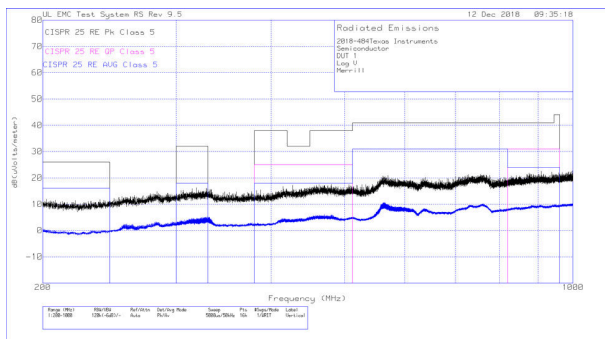

$V_{IN} = 12\text{ V}$        $V_{OUT} = 5\text{ V}$        $I_{OUT} = 3\text{ A}$   
 $f_{SW} = 400\text{ kHz}$       RNX package

**Figure 8-27. Radiated EMI Log-periodic Antenna (Vertical)**

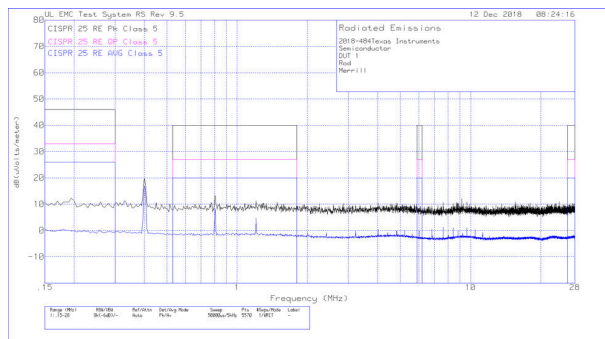

$V_{IN} = 12\text{ V}$        $V_{OUT} = 5\text{ V}$        $I_{OUT} = 3\text{ A}$   
 $f_{SW} = 400\text{ kHz}$       RNX package

**Figure 8-28. Radiated EMI Rod Antenna**

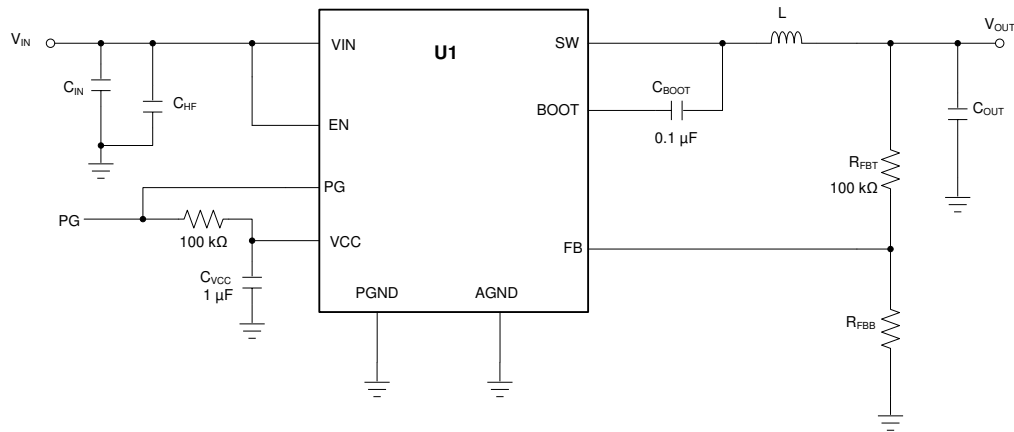

Figure 8-29. Circuit for Application Curves

Table 8-3. BOM for Typical Application Curves RNX Package <sup>(1)</sup>

V <sub>OUT</sub>	FREQUENCY	R <sub>FBB</sub>	C <sub>OUT</sub>	C <sub>IN</sub> + C <sub>HF</sub>	L	U1
3.3 V	400 kHz	43.3 kΩ	4 × 22 μF	2 × 4.7 μF + 2 × 100 nF	6.8 μH, 14 mΩ	LMR33630ARNX
3.3 V	1400 KHz	43.3 kΩ	4 × 22 μF	2 × 4.7 μF + 2 × 100 nF	2.2 μH, 11.4 mΩ	LMR33630BRNX
3.3 V	2100 kHz	43.3 kΩ	4 × 22 μF	2 × 4.7 μF + 2 × 100 nF	1.2 μH, 7 mΩ	LMR33630CRNX
5 V	400 kHz	24.9 kΩ	4 × 22 μF	2 × 4.7 μF + 2 × 100 nF	8 μH, 25 mΩ	LMR33630ARNX
5 V	1400 KHz	24.9 kΩ	4 × 22 μF	2 × 4.7 μF + 2 × 100 nF	2.2 μH, 11.4 mΩ	LMR33630BRNX
5 V	2100 kHz	24.9 kΩ	4 × 22 μF	2 × 4.7 μF + 2 × 100 nF	1.5 μH, 8.2 mΩ	LMR33630CRNX

(1) The values in this table were selected to enhance certain performance criteria and may not represent typical values.

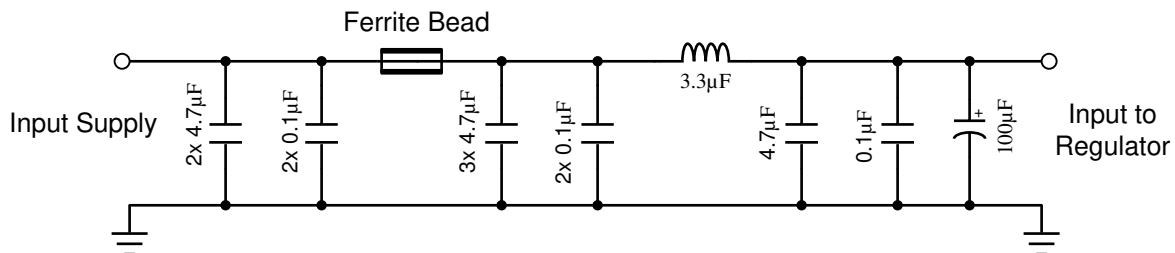

Figure 8-30. Typical Input EMI Filter  
Filter Used Only for EMI Measurements Found in Application Curves

### 8.3 What to Do and What Not to Do

- **Don't:** Exceed the *Absolute Maximum Ratings*.
- **Don't:** Exceed the *ESD Ratings*.
- **Don't:** Exceed the *Recommended Operating Conditions*.
- **Don't:** Allow the EN input to float.
- **Don't:** Allow the output voltage to exceed the input voltage, nor go below ground.
- **Don't:** Use the value of R<sub>θJA</sub> given in the *Thermal Information* table to design your application. Use the information in the *Maximum Ambient Temperature* section.
- **Do:** Follow all the guidelines and suggestions found in this data sheet before committing the design to production. TI application engineers are ready to help critique your design and PCB layout to help make your project a success (see *Section 11.3*).

## 9 Power Supply Recommendations

The characteristics of the input supply must be compatible with [Section 6.1](#) and [Section 6.3](#) found in this data sheet. In addition, the input supply must be capable of delivering the required input current to the loaded regulator. The average input current can be estimated with [Equation 12](#), where  $\eta$  is the efficiency.

$$I_{IN} = \frac{V_{OUT} \cdot I_{OUT}}{V_{IN} \cdot \eta} \quad (12)$$

If the regulator is connected to the input supply through long wires or PCB traces, special care is required to achieve good performance. The parasitic inductance and resistance of the input cables can have an adverse effect on the operation of the regulator. The parasitic inductance, in combination with the low-ESR, ceramic input capacitors, can form an under damped resonant circuit, resulting in overvoltage transients at the input to the regulator. The parasitic resistance can cause the voltage at the VIN pin to dip whenever a load transient is applied to the output. If the application is operating close to the minimum input voltage, this dip can cause the regulator to momentarily shutdown and reset. The best way to solve these kind of issues is to reduce the distance from the input supply to the regulator and/or use an aluminum or tantalum input capacitor in parallel with the ceramics. The moderate ESR of these types of capacitors help damp the input resonant circuit and reduce any overshoots. A value in the range of 20  $\mu$ F to 100  $\mu$ F is usually sufficient to provide input damping and help to hold the input voltage steady during large load transients.

Sometimes, for other system considerations, an input filter is used in front of the regulator. This can lead to instability, as well as some of the effects mentioned above, unless it is designed carefully. The user guide [AN-2162 Simple Success With Conducted EMI From DCDC Converters](#) provides helpful suggestions when designing an input filter for any switching regulator.

In some cases, a transient voltage suppressor (TVS) is used on the input of regulators. One class of this device has a *snap-back* characteristic (thyristor type). The use of a device with this type of characteristic is not recommended. When the TVS fires, the clamping voltage falls to a very low value. If this voltage is less than the output voltage of the regulator, the output capacitors discharge through the device back to the input. This uncontrolled current flow can damage the device.

The input voltage must not be allowed to fall below the output voltage. In this scenario, such as a shorted input test, the output capacitors discharges through the internal parasitic diode found between the VIN and SW pins of the device. During this condition, the current can become uncontrolled, possibly causing damage to the device. If this scenario is considered likely, then a Schottky diode between the input supply and the output should be used.

## 10 Layout

### 10.1 Layout Guidelines

The PCB layout of any DC/DC converter is critical to the optimal performance of the design. Bad PCB layout can disrupt the operation of an otherwise good schematic design. Even if the converter regulates correctly, bad PCB layout can mean the difference between a robust design and one that cannot be mass produced. Furthermore, the EMI performance of the regulator is dependent on the PCB layout, to a great extent. In a buck converter, the most critical PCB feature is the loop formed by the input capacitor or input capacitors, and power ground, as shown in [Figure 10-1](#). This loop carries large transient currents that can cause large transient voltages when reacting with the trace inductance. These unwanted transient voltages will disrupt the proper operation of the converter. Because of this, the traces in this loop must be wide and short, and the loop area as small as possible to reduce the parasitic inductance. [Figure 10-2](#) shows a recommended layout for the critical components of the LMR33630-Q1.

1. **Place the input capacitor or capacitors as close as possible to the VIN and GND terminals.** VIN and GND pins are adjacent, simplifying the input capacitor placement. With the VQFN package there are two VIN/PGND pairs on either side of the package. This provides for a symmetrical layout and helps minimize switching noise and EMI generation. A wide VIN plane must be used on a lower layer to connect both of the VIN pairs together to the input supply; see [Figure 10-2](#).
2. **Place bypass capacitor for VCC close to the VCC pin.** This capacitor must be placed close to the device and routed with short, wide traces to the VCC and GND pins.
3. **Use wide traces for the C<sub>BOOT</sub> capacitor.** Place C<sub>BOOT</sub> close to the device with short/wide traces to the BOOT and SW pins. It is important to route the SW connection under the device to the NC pin, and use this path to connect the BOOT capacitor to SW.
4. **Place the feedback divider as close as possible to the FB pin of the device.** Place R<sub>FBB</sub>, R<sub>FBT</sub>, and C<sub>FF</sub>, if used, physically close to the device. The connections to FB and GND must be short and close to those pins on the device. The connection to V<sub>OUT</sub> can be somewhat longer. However, this latter trace must not be routed near any noise source (such as the SW node) that can capacitively couple into the feedback path of the regulator.
5. **Use at least one ground plane in one of the middle layers.** This plane acts as a noise shield and also act as a heat dissipation path.
6. **Provide wide paths for VIN, VOUT, and GND.** Making these paths as wide and direct as possible reduces any voltage drops on the input or output paths of the converter and maximizes efficiency.
7. **Provide enough PCB area for proper heat sinking.** As stated in [Section 8.2.2.11](#), enough copper area must be used to ensure a low R<sub>θJA</sub>, commensurate with the maximum load current and ambient temperature. Make the top and bottom PCB layers with two-ounce copper; and no less than one ounce. If the PCB design uses multiple copper layers (recommended), thermal vias can also be connected to the inner layer heat-spreading ground planes.
8. **Keep switch area small.** Keep the copper area connecting the SW pin to the inductor as short and wide as possible. At the same time the total area of this node should be minimized to help reduce radiated EMI.

See the following PCB layout resources for additional important guidelines:

- [Layout Guidelines for Switching Power Supplies](#)
- [Simple Switcher PCB Layout Guidelines](#)
- [Construction Your Power Supply- Layout Considerations](#)
- [Low Radiated EMI Layout Made Simple with LM4360x and LM4600x](#)



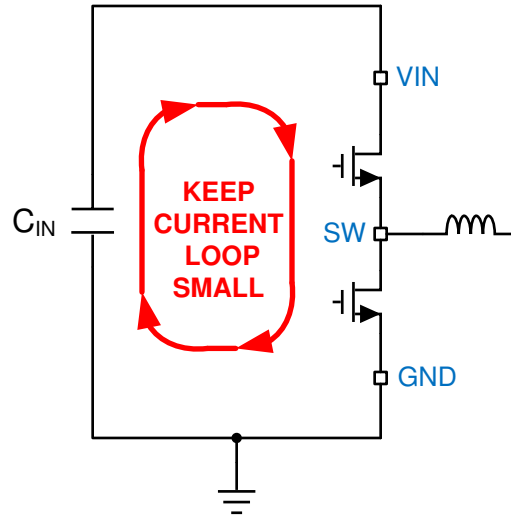

**Figure 10-1. Current Loops with Fast Edges**

### 10.1.1 Ground and Thermal Considerations

As mentioned above, TI recommends using one of the middle layers as a solid ground plane. A ground plane provides shielding for sensitive circuits and traces. It also provides a quiet reference potential for the control circuitry. The AGND and PGND pins must be connected to the ground planes using vias next to the bypass capacitors. PGND pins are connected directly to the source of the low side MOSFET switch, and also connected directly to the grounds of the input and output capacitors. The PGND net contains noise at the switching frequency and can bounce due to load variations. The PGND trace, as well as the VIN and SW traces, must be constrained to one side of the ground planes. The other side of the ground plane contains much less noise and must be used for sensitive routes.

Use as much copper as possible, for system ground plane, on the top and bottom layers for the best heat dissipation. Use a four-layer board with the copper thickness for the four layers, starting from the top as: 2 oz / 1 oz / 1 oz / 2 oz. A four-layer board with enough copper thickness, and proper layout, provides low current conduction impedance, proper shielding, and lower thermal resistance.

## 10.2 Layout Example

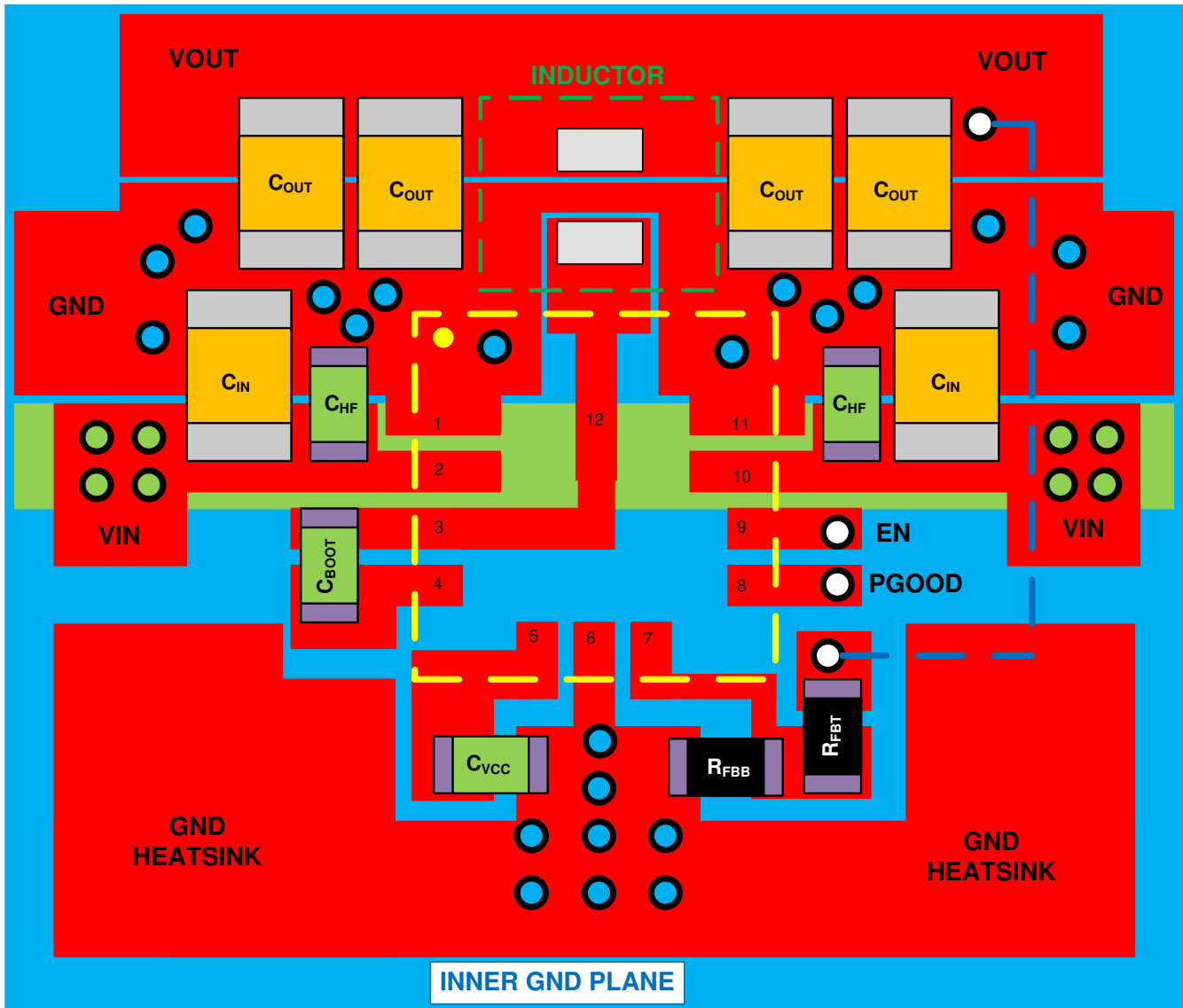

- Top Trace/Plane
- Inner GND Plane
- VIN Strap on Inner Layer
- VIA to Signal Layer
- VIA to GND Planes
- VIA to VIN Strap
- Trace on Signal Layer

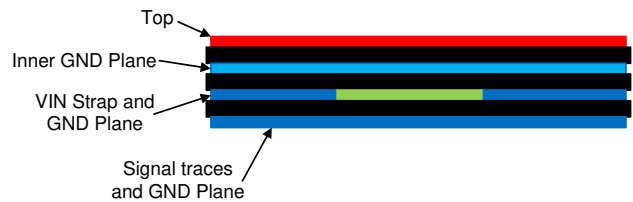

Figure 10-2. Example Layout for VQFN Package

## 11 Device and Documentation Support

### 11.1 Device Support

#### 11.1.1 Development Support

##### 11.1.1.1 Custom Design With WEBENCH® Tools

[Click here](#) to create a custom design using the LMR33630-Q1 device with the WEBENCH® Power Designer.

1. Start by entering the input voltage ( $V_{IN}$ ), output voltage ( $V_{OUT}$ ), and output current ( $I_{OUT}$ ) requirements.
2. Optimize the design for key parameters such as efficiency, footprint, and cost using the optimizer dial.
3. Compare the generated design with other possible solutions from Texas Instruments.

The WEBENCH Power Designer provides a customized schematic along with a list of materials with real-time pricing and component availability.

In most cases, these actions are available:

- Run electrical simulations to see important waveforms and circuit performance
- Run thermal simulations to understand board thermal performance
- Export customized schematic and layout into popular CAD formats
- Print PDF reports for the design, and share the design with colleagues

Get more information about WEBENCH tools at [www.ti.com/WEBENCH](http://www.ti.com/WEBENCH).

### 11.2 Documentation Support

#### 11.2.1 Related Documentation

For related documentation see the following:

- [Thermal Design by Insight not Hindsight](#)
- [A Guide to Board Layout for Best Thermal Resistance for Exposed Pad Packages](#)
- [Semiconductor and IC Package Thermal Metrics](#)
- [Thermal Design Made Simple with LM43603 and LM43602](#)
- [PowerPAD™ Thermally Enhanced Package](#)
- [PowerPAD™ Made Easy](#)
- [Using New Thermal Metrics](#)
- [Layout Guidelines for Switching Power Supplies](#)
- [Simple Switcher PCB Layout Guidelines](#)
- [Construction Your Power Supply- Layout Considerations](#)
- [Low Radiated EMI Layout Made Simple with LM4360x and LM4600x](#)

### 11.3 Support Resources

TI E2E™ support forums are an engineer's go-to source for fast, verified answers and design help — straight from the experts. Search existing answers or ask your own question to get the quick design help you need.

Linked content is provided "AS IS" by the respective contributors. They do not constitute TI specifications and do not necessarily reflect TI's views; see TI's [Terms of Use](#).

### 11.4 Receiving Notification of Documentation Updates

To receive notification of documentation updates, navigate to the device product folder on [ti.com](http://ti.com). Click on *Subscribe to updates* to register and receive a weekly digest of any product information that has changed. For change details, review the revision history included in any revised document.

### 11.5 Trademarks

HotRod™, PowerPAD™, TI E2E™ are trademarks of Texas Instruments.

WEBENCH® is a registered trademark of Texas Instruments.

All other trademarks are the property of their respective owners.

## 11.6 Electrostatic Discharge Caution



This integrated circuit can be damaged by ESD. Texas Instruments recommends that all integrated circuits be handled with appropriate precautions. Failure to observe proper handling and installation procedures can cause damage.

ESD damage can range from subtle performance degradation to complete device failure. Precision integrated circuits may be more susceptible to damage because very small parametric changes could cause the device not to meet its published specifications.

## 11.7 Glossary

### TI Glossary

This glossary lists and explains terms, acronyms, and definitions.

## **Mechanical, Packaging, and Orderable Information**

The following pages include mechanical, packaging, and orderable information. This information is the most current data available for the designated devices. This data is subject to change without notice and revision of this document. For browser-based versions of this data sheet, refer to the left-hand navigation.

**PACKAGING INFORMATION**

Orderable Device	Status (1)	Package Type	Package Drawing	Pins	Package Qty	Eco Plan (2)	Lead finish/ Ball material (6)	MSL Peak Temp (3)	Op Temp (°C)	Device Marking (4/5)	Samples
LMR33630AQRNXRQ1	ACTIVE	VQFN-HR	RNX	12	3000	RoHS & Green	SN	Level-2-260C-1 YEAR	-40 to 125	Z630AQ	<a href="#">Samples</a>
LMR33630AQRNXTQ1	ACTIVE	VQFN-HR	RNX	12	250	RoHS & Green	SN	Level-2-260C-1 YEAR	-40 to 125	Z630AQ	<a href="#">Samples</a>
LMR33630BQRNXRQ1	ACTIVE	VQFN-HR	RNX	12	3000	RoHS & Green	SN	Level-2-260C-1 YEAR	-40 to 125	Z630BQ	<a href="#">Samples</a>
LMR33630BQRNXTQ1	ACTIVE	VQFN-HR	RNX	12	250	RoHS & Green	SN	Level-2-260C-1 YEAR	-40 to 125	Z630BQ	<a href="#">Samples</a>
LMR33630CQRNXRQ1	ACTIVE	VQFN-HR	RNX	12	3000	RoHS & Green	SN	Level-2-260C-1 YEAR	-40 to 125	Z630CQ	<a href="#">Samples</a>
LMR33630CQRNXTQ1	ACTIVE	VQFN-HR	RNX	12	250	RoHS & Green	SN	Level-2-260C-1 YEAR	-40 to 125	Z630CQ	<a href="#">Samples</a>

(1) The marketing status values are defined as follows:

**ACTIVE:** Product device recommended for new designs.

**LIFEBUY:** TI has announced that the device will be discontinued, and a lifetime-buy period is in effect.

**NRND:** Not recommended for new designs. Device is in production to support existing customers, but TI does not recommend using this part in a new design.

**PREVIEW:** Device has been announced but is not in production. Samples may or may not be available.

**OBSOLETE:** TI has discontinued the production of the device.

(2) **RoHS:** TI defines "RoHS" to mean semiconductor products that are compliant with the current EU RoHS requirements for all 10 RoHS substances, including the requirement that RoHS substance do not exceed 0.1% by weight in homogeneous materials. Where designed to be soldered at high temperatures, "RoHS" products are suitable for use in specified lead-free processes. TI may reference these types of products as "Pb-Free".

**RoHS Exempt:** TI defines "RoHS Exempt" to mean products that contain lead but are compliant with EU RoHS pursuant to a specific EU RoHS exemption.

**Green:** TI defines "Green" to mean the content of Chlorine (Cl) and Bromine (Br) based flame retardants meet JS709B low halogen requirements of <=1000ppm threshold. Antimony trioxide based flame retardants must also meet the <=1000ppm threshold requirement.

(3) MSL, Peak Temp. - The Moisture Sensitivity Level rating according to the JEDEC industry standard classifications, and peak solder temperature.

(4) There may be additional marking, which relates to the logo, the lot trace code information, or the environmental category on the device.

(5) Multiple Device Markings will be inside parentheses. Only one Device Marking contained in parentheses and separated by a "~" will appear on a device. If a line is indented then it is a continuation of the previous line and the two combined represent the entire Device Marking for that device.

(6) Lead finish/Ball material - Orderable Devices may have multiple material finish options. Finish options are separated by a vertical ruled line. Lead finish/Ball material values may wrap to two lines if the finish value exceeds the maximum column width.

**Important Information and Disclaimer:** The information provided on this page represents TI's knowledge and belief as of the date that it is provided. TI bases its knowledge and belief on information provided by third parties, and makes no representation or warranty as to the accuracy of such information. Efforts are underway to better integrate information from third parties. TI has taken and continues to take reasonable steps to provide representative and accurate information but may not have conducted destructive testing or chemical analysis on incoming materials and chemicals. TI and TI suppliers consider certain information to be proprietary, and thus CAS numbers and other limited information may not be available for release.

In no event shall TI's liability arising out of such information exceed the total purchase price of the TI part(s) at issue in this document sold by TI to Customer on an annual basis.

**OTHER QUALIFIED VERSIONS OF LMR33630-Q1 :**

- Catalog: [LMR33630](#)

NOTE: Qualified Version Definitions:

- Catalog - TI's standard catalog product

**TAPE AND REEL INFORMATION**

**QUADRANT ASSIGNMENTS FOR PIN 1 ORIENTATION IN TAPE**

\*All dimensions are nominal

Device	Package Type	Package Drawing	Pins	SPQ	Reel Diameter (mm)	Reel Width W1 (mm)	A0 (mm)	B0 (mm)	K0 (mm)	P1 (mm)	W (mm)	Pin1 Quadrant
LMR33630AQRNXRQ1	VQFN-HR	RNX	12	3000	180.0	8.4	2.3	3.2	1.0	4.0	8.0	Q1
LMR33630AQRNXTQ1	VQFN-HR	RNX	12	250	180.0	8.4	2.3	3.2	1.0	4.0	8.0	Q1
LMR33630BQRNXRQ1	VQFN-HR	RNX	12	3000	180.0	8.4	2.3	3.2	1.0	4.0	8.0	Q1
LMR33630BQRNXTQ1	VQFN-HR	RNX	12	250	180.0	8.4	2.3	3.2	1.0	4.0	8.0	Q1
LMR33630CQRNXRQ1	VQFN-HR	RNX	12	3000	180.0	8.4	2.3	3.2	1.0	4.0	8.0	Q1
LMR33630CQRNXTQ1	VQFN-HR	RNX	12	250	180.0	8.4	2.3	3.2	1.0	4.0	8.0	Q1



**TAPE AND REEL BOX DIMENSIONS**

\*All dimensions are nominal

Device	Package Type	Package Drawing	Pins	SPQ	Length (mm)	Width (mm)	Height (mm)
LMR33630AQRNXRQ1	VQFN-HR	RNX	12	3000	213.0	191.0	35.0
LMR33630AQRNXTQ1	VQFN-HR	RNX	12	250	213.0	191.0	35.0
LMR33630BQRNXRQ1	VQFN-HR	RNX	12	3000	213.0	191.0	35.0
LMR33630BQRNXTQ1	VQFN-HR	RNX	12	250	213.0	191.0	35.0
LMR33630CQRNXRQ1	VQFN-HR	RNX	12	3000	213.0	191.0	35.0
LMR33630CQRNXTQ1	VQFN-HR	RNX	12	250	213.0	191.0	35.0

## GENERIC PACKAGE VIEW

**RNX 12**

**VQFN-HR - 1 mm max height**

**2 x 3 mm, 0.5 mm pitch**

PLASTIC QUAD FLATPACK-NO LEAD

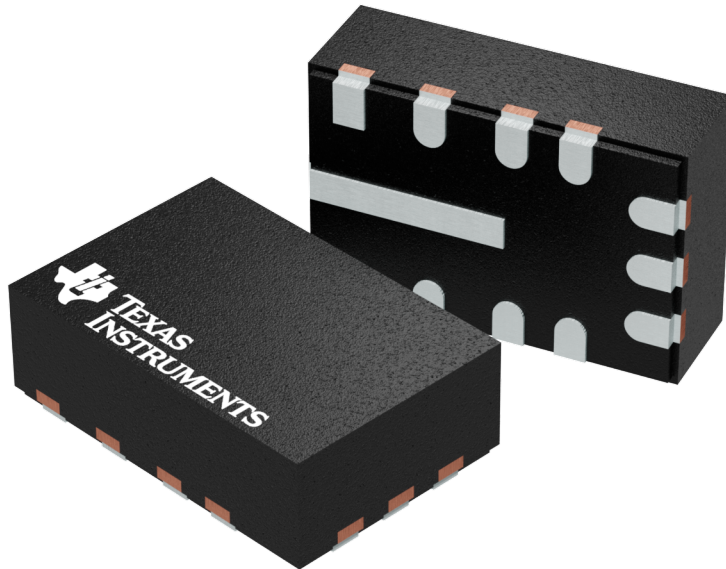

Images above are just a representation of the package family, actual package may vary.  
Refer to the product data sheet for package details.

4224286/A

# RNX0012B



# PACKAGE OUTLINE

## VQFN-HR - 0.9 mm max height

PLASTIC QUAD FLATPACK - NO LEAD

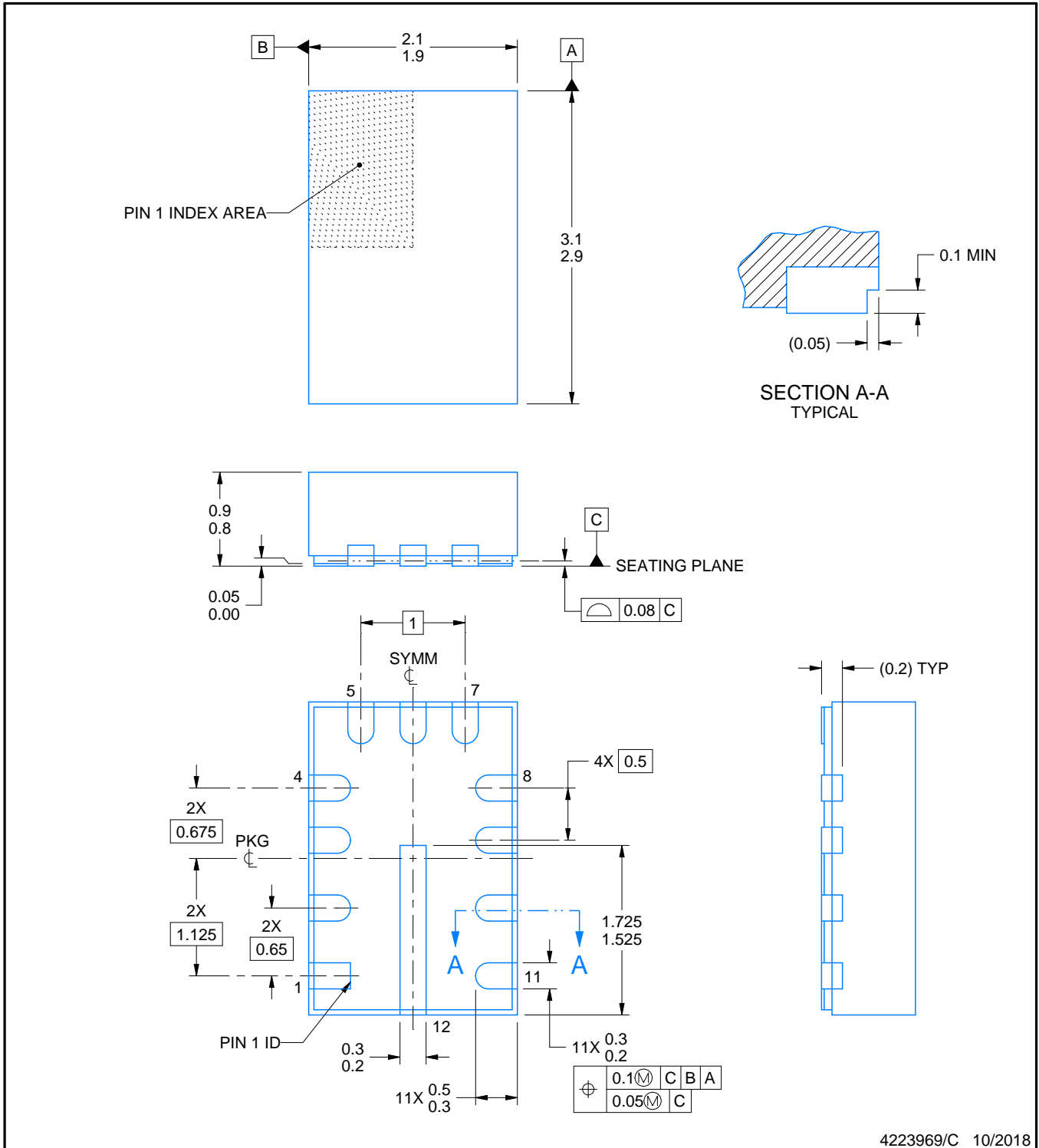

4223969/C 10/2018

### NOTES:

1. All linear dimensions are in millimeters. Any dimensions in parenthesis are for reference only. Dimensioning and tolerancing per ASME Y14.5M.
2. This drawing is subject to change without notice.
3. The package thermal pad must be soldered to the printed circuit board for thermal and mechanical performance.

# EXAMPLE BOARD LAYOUT

RNX0012B

VQFN-HR - 0.9 mm max height

PLASTIC QUAD FLATPACK - NO LEAD

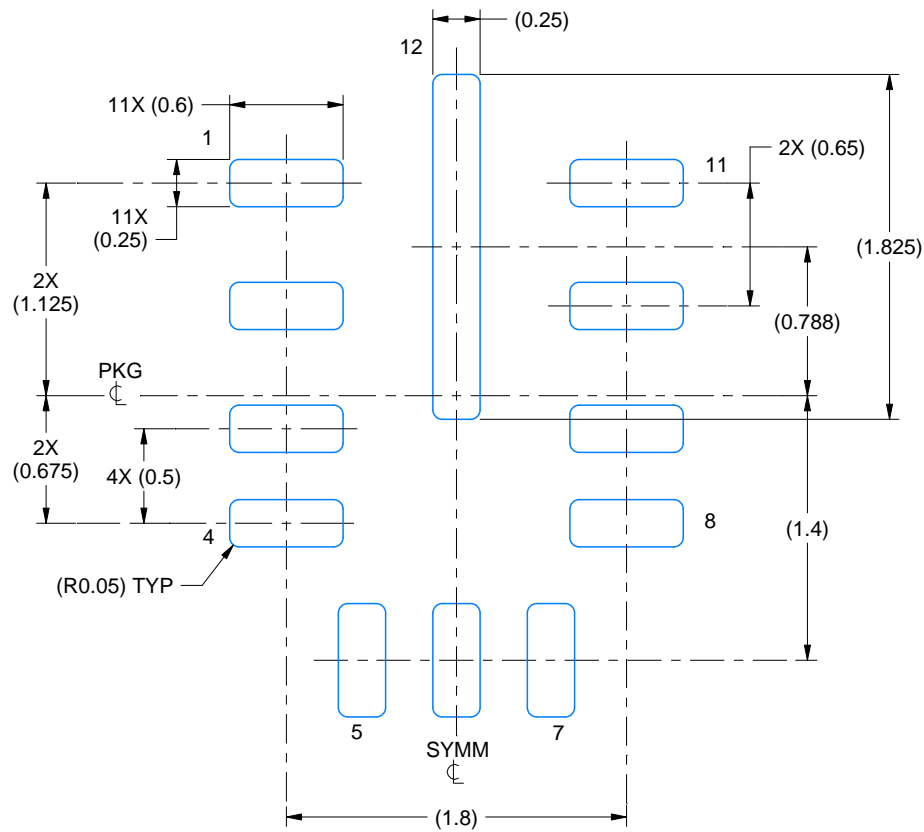

LAND PATTERN EXAMPLE  
EXPOSED METAL SHOWN  
SCALE:25X

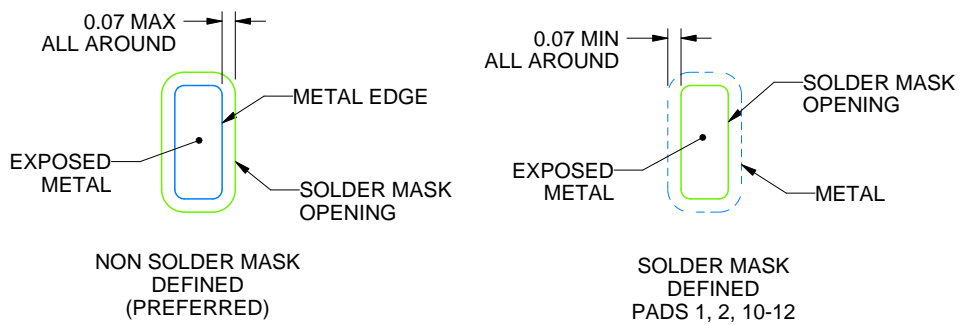

SOLDER MASK DETAILS

4223969/C 10/2018

NOTES: (continued)

4. This package is designed to be soldered to a thermal pad on the board. For more information, see Texas Instruments literature number SLUA271 ([www.ti.com/lit/slua271](http://www.ti.com/lit/slua271)).

# EXAMPLE STENCIL DESIGN

RNX0012B

VQFN-HR - 0.9 mm max height

PLASTIC QUAD FLATPACK - NO LEAD

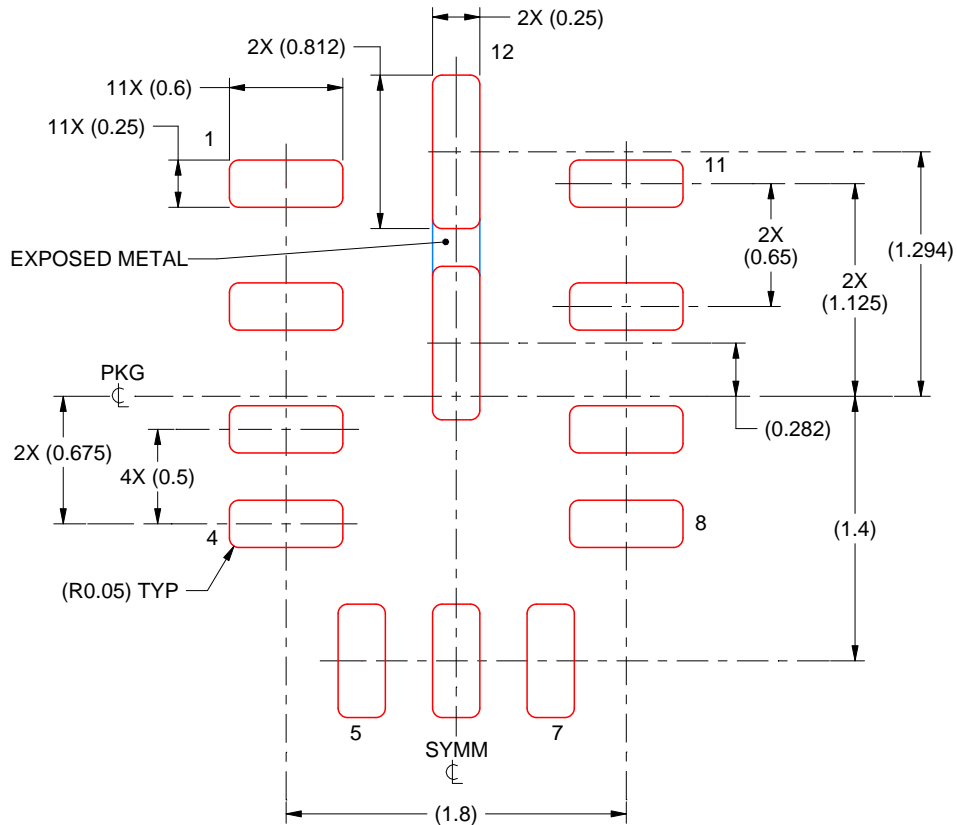

SOLDER PASTE EXAMPLE  
BASED ON 0.125 mm THICK STENCIL

FOR PAD 12  
87.7% PRINTED SOLDER COVERAGE BY AREA  
SCALE:25X

4223969/C 10/2018

NOTES: (continued)

5. Laser cutting apertures with trapezoidal walls and rounded corners may offer better paste release. IPC-7525 may have alternate design recommendations.

## IMPORTANT NOTICE AND DISCLAIMER

TI PROVIDES TECHNICAL AND RELIABILITY DATA (INCLUDING DATASHEETS), DESIGN RESOURCES (INCLUDING REFERENCE DESIGNS), APPLICATION OR OTHER DESIGN ADVICE, WEB TOOLS, SAFETY INFORMATION, AND OTHER RESOURCES "AS IS" AND WITH ALL FAULTS, AND DISCLAIMS ALL WARRANTIES, EXPRESS AND IMPLIED, INCLUDING WITHOUT LIMITATION ANY IMPLIED WARRANTIES OF MERCHANTABILITY, FITNESS FOR A PARTICULAR PURPOSE OR NON-INFRINGEMENT OF THIRD PARTY INTELLECTUAL PROPERTY RIGHTS.

These resources are intended for skilled developers designing with TI products. You are solely responsible for (1) selecting the appropriate TI products for your application, (2) designing, validating and testing your application, and (3) ensuring your application meets applicable standards, and any other safety, security, or other requirements. These resources are subject to change without notice. TI grants you permission to use these resources only for development of an application that uses the TI products described in the resource. Other reproduction and display of these resources is prohibited. No license is granted to any other TI intellectual property right or to any third party intellectual property right. TI disclaims responsibility for, and you will fully indemnify TI and its representatives against, any claims, damages, costs, losses, and liabilities arising out of your use of these resources.

TI's products are provided subject to TI's Terms of Sale (<https://www.ti.com/legal/termsofsale.html>) or other applicable terms available either on [ti.com](https://www.ti.com) or provided in conjunction with such TI products. TI's provision of these resources does not expand or otherwise alter TI's applicable warranties or warranty disclaimers for TI products.

Mailing Address: Texas Instruments, Post Office Box 655303, Dallas, Texas 75265  
Copyright © 2021, Texas Instruments Incorporated